

 <p>M.D. Micro Detectors Strada S. Caterina, 235 41122 Modena Italy Tel. +39 059 420411 Fax +39 059 253973 www.microdetectors.com info@microdetectors.com</p>	<b>CX0 SERIES</b> <b>LIGHT CURTAINS</b>		<b>LANGUAGE</b>
	<b>Installation and Operation Manual</b>		<b>ENGLISH</b>

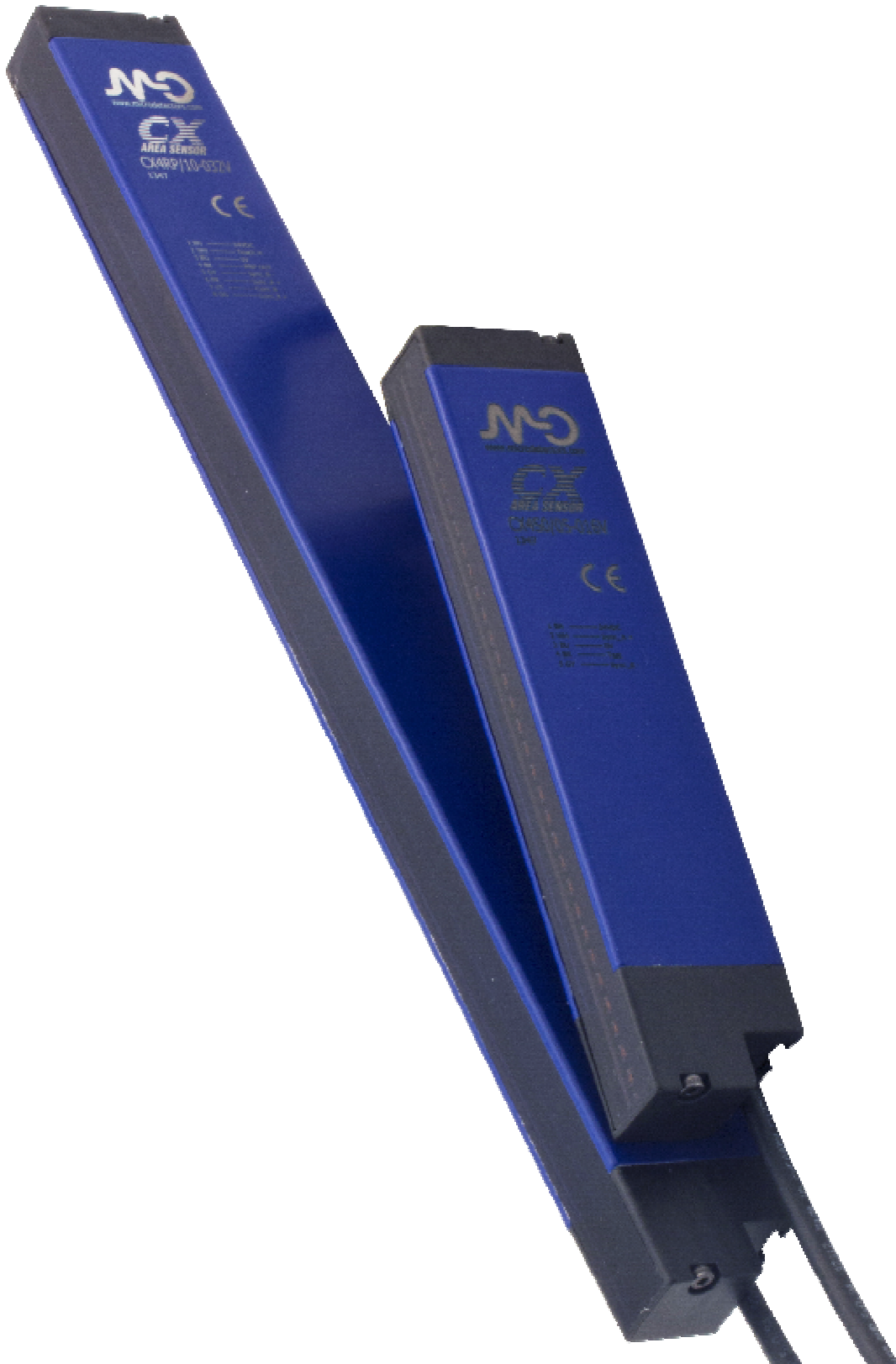

 <b>Micro Detectors</b> Italian Sensors Technology	<b>M.D. Micro Detectors</b> Strada S. Caterina, 235 41122 Modena Italy Tel. +39 059 420411 Fax +39 059 253973 www.microdetectors.com info@microdetectors.com	<b>CX0 SERIES</b> <b>LIGHT CURTAINS</b>	<b>LANGUAGE</b>
		<b>Installation and Operation Manual</b>	<b>ENGLISH</b>

## SUMMARY

<b>1.0</b>	<b>GENERAL</b> .....	<b>3</b>
1.1	Function of this manual.....	3
1.2	Explanation of symbols.....	3
<b>2.0</b>	<b>SAFETY AND PROPER USE</b> .....	<b>3</b>
<b>3.0</b>	<b>PRODUCT DESCRIPTION</b> .....	<b>4</b>
3.1	Short description .....	4
3.2	Available models.....	4
<b>4.0</b>	<b>START-UP INSTRUCTIONS</b> .....	<b>4</b>
4.1	Mechanical mounting of CX0 models.....	4
4.1	Electrical installation. ....	4
4.2	Alignment of CX0E1RP models .....	5
4.3	Verify alignment for CX0 E1RP models.....	5
4.4	Electrical drawing.....	5
4.5	Panel indications and diagnostics.....	7
<b>5.0</b>	<b>TECHNICAL SPECIFICATIONS.</b> .....	<b>8</b>
<b>6.0</b>	<b>DETECTION</b> .....	<b>9</b>
6.1	Signal margin .....	9
6.2	Detection capability.....	10
<b>7.0</b>	<b>MECHANICAL DIMENSIONS OF LIGHT CURTAINS AND STANDARD ACCESSORIES</b> .....	<b>11</b>
7.1	Mechanical dimensions of CX0 light curtains.....	11
7.2	Standard Mounting accessories .....	12
<b>8.0</b>	<b>MOUNTING OF CX0 LIGHT CURTAINS</b> .....	<b>12</b>
<b>9.0</b>	<b>PACKAGE CONTENT</b> .....	<b>13</b>
<b>10.0</b>	<b>CONTROL OF THE INSTALLED LIGHT CURTAINS</b> .....	<b>13</b>
10.1	Purpose of controls. ....	13
10.2	Preliminary controls before start-up.....	13
10.3	Controls of device efficiency .....	13
<b>11.0</b>	<b>CE-CONFORMITY DECLARATION</b> .....	<b>13</b>
<b>12.0</b>	<b>WARRANTY</b> .....	<b>13</b>

 <p>M.D. Micro Detectors Strada S. Caterina, 235 41122 Modena Italy Tel. +39 059 420411 Fax +39 059 253973 www.microdetectors.com info@microdetectors.com</p>	<b>CX0 SERIES LIGHT CURTAINS</b>	<b>LANGUAGE</b>
	<b>Installation and Operation Manual</b>	

## 1.0 GENERAL

Please attentively read this manual before installation, start-up, use and maintenance of **CX0** light curtains. This manual contains detailed instructions that must be carefully followed.

### THIS MANUAL IS NOT IN THE ORIGINAL LANGUAGE

#### 1.1 Function of this manual

This manual provides the user with the necessary instructions for safe and proper installation, electrical connection, start-up, use and maintenance of **CX0** light curtains.

#### 1.2 Explanation of symbols



##### Warning

A warning sign indicates actual or potential hazards. It indicates procedures and behaviours which can be useful to prevent accidents. Read and follow these instructions carefully.



##### Indication

It refers to indications that can help achieve better performances.



##### Emitter

It identifies devices that have the function of Emitter.



##### Receiver

It identifies devices that have the function of Receiver.

## 2.0 SAFETY AND PROPER USE



##### Warning

This is NOT a protective device. Therefore, it should not be used to guarantee personnel safety.



##### Warning

This is a low-voltage, direct current device. Proper functioning is only guaranteed between **16.8V<sub>DC</sub>** and **30V<sub>DC</sub>**. Under **15V<sub>DC</sub>** voltage all outputs are in an OFF state. Over **30V<sub>DC</sub> permanent voltage** the device may be damaged.

When the device is switched on, outputs are inactive for a certain amount of time known as **power on delay** (see Tab.:5.1).



##### Warning

The Emitter emits near-infrared light at non-dangerous levels. The device is classified as **RGO** (exempt) according to **IEC 62471: 2008-09**.



##### Warning

Please make sure that light curtains are used in proper environmental conditions. Automatic calibration must always be carried out aiming for the best possible alignment. More than one calibration may be necessary to guarantee the best alignment. Check any reflective surface next to the light beams which may influence them. Check any transparent panels or similar panels which may change the beam angle of the light curtains. Prevent the light curtain's optical window from getting scratched or tarnished. Do not expose the receiver to strong natural or artificial light sources, including stroboscopic light. Do not expose the receiver directly to optical beams projected by other optical devices. Ensure that the ambient temperature does not exceed the stated limits. Bear in mind that smoke, vapour, liquids and powders may alter transparency of air or dirty the optical window. Dispose of unusable or irreparable devices always in accordance with national regulations regarding waste disposal.

 <b>Micro Detectors</b> Italian Sensors Technology	<b>M.D. Micro Detectors</b> Strada S. Caterina, 235 41122 Modena Italy Tel. +39 059 420411 Fax +39 059 253973 www.microdetectors.com info@microdetectors.com	<b>CX0 SERIES</b> <b>LIGHT CURTAINS</b>	<b>LANGUAGE</b>
		<b>Installation and Operation Manual</b>	<b>ENGLISH</b>

### 3.0 PRODUCT DESCRIPTION

#### 3.1 Short description

**CX0** light curtains are photoelectric devices built according to the **IEC 60497-5-2** norms and they must **not** be considered as safety devices. Therefore they must not be used to guarantee operators' safety nor to protect users on dangerous machines. They must rather be used to detect objects reducing or obscuring the intensity of light beams hitting the receiver.

The housing is in **RAL5002** aluminium, painted in blue, size **20x36 mm**, (20 mm refers to the front side). A groove on the back allows connection with T-shaped components. The top and bottom side are in black **PBT**, the optical window is in **PC**, Protection degree is **IP67**.

In all **CX0** models optics are completely crossed. Optical paths are defined by means of parallel rays and by rays departing from each single emitter and reaching each single receiver. This close optical net allows to detect objects with a diameter that is at least the **1/2 optic pitch**. **CX0** models can also detect partially transparent sheets of different width, according to the sensing range, see **W** in **Fig.:6.1**.

Models of this series can be delivered either with **5mm**-pitch and controlled height of **155mm**, or with **10mm**-pitch and controlled height of **160, 310mm**. Controlled height is indicated in the item code which goes from **016** to **032**. In all models, the axis of the first and last optical elements are at **4.5 mm** from the housing edge. Therefore, the housing is always 9mm higher than the optical elements.

These models can only indicate if there are interrupted beams or not, without identifying which ones are interrupted, therefore they can only drive the digital outputs and define only two states: **DARK** or **LIGHT**.

#### 3.2 Available models

MODEL	Optical Pitch (1)	Optical height (1)	Light curtain Height (1)	Last optic (1)	Beams	Working distance (2)	Response Time Light-Dark (2)	Response Time Dark-Light (2)	Inputs / Outputs	NOTES
	P	h	H	D	Sn	T <sub>LD</sub>	T <sub>DL</sub>			
CODE ARTICLE	mm	mm	mm	mm	N°	m	ms	ms		
<b>CX0E1RP-05-016V</b>	<b>5</b>	<b>155</b>	<b>169</b>	<b>9.5</b>	<b>32</b>	<b>0.3...3</b>	<b>0.15...6.6</b>	<b>1...11</b>	<b>Teach G/F. NC/NO; PNP</b>	Only detection with cross-beams <b>One</b> kit of ST151 is delivered
<b>CX0E1RP-10-016V</b>	<b>10</b>	<b>160</b>	<b>169</b>	<b>4.5</b>	<b>17</b>	<b>0.5...6</b>	<b>0.15...3.6</b>	<b>0.5...5.3</b>	<b>Teach G/F. NC/NO; PNP</b>	Only detection with cross-beams <b>One</b> kit of ST151 is delivered
<b>CX0E1RP-10-032V</b>	<b>10</b>	<b>310</b>	<b>329</b>	<b>14.5</b>	<b>32</b>	<b>1...6</b>	<b>0.15...6.6</b>	<b>0.15...6.6</b>	<b>Teach G/F. NC/NO; PNP</b>	Only detection with cross-beams <b>Two</b> kits of ST151 are delivered

**Tab.:3.1**

#### Notes:

**(1)** For further details see **Fig.: 7.1**

**(2)** Working distances less than the minimum are possible if one accepts sensing capabilities in excess of half the pitch.

For further information and details see **Tab.: 5.1, 5.2, 5.3, 5.4 ; Fig.:5.1**

### 4.0 START-UP INSTRUCTIONS

#### 4.1 Mechanical mounting of CX0 models

It is extremely important to secure the light curtains to a rigid structure, not subject to deformation or strong vibrations.

Decide where to place the Receiver so that it is not subject to strong natural or artificial light sources nor to luminous interference of other sensors.

Place Emitter and Receiver in front of each other, at the same height over the reference surface. On the CX0 models it is not necessary to keep the same orientation. For example, one of the two elements can be turned upside down without preventing the correct functioning of the light curtain.

The distance between the two elements must not exceed the limits set by the specifications. To secure the safety light curtains to a supporting structure, use the inserts which must be applied to the rear groove and the brackets which are provided (mounting accessory **ST151**).

If the application is subject to vibrations, which anyway do not prevent the optical alignment, use damping supports.

The optical beams can be partially deflected by nearby reflective surfaces. Because of that, the path beam interruption may not be detected, therefore, all the reflective surfaces should be positioned at a minimum distance (**Rs**) from the optical axis, **Rs** depends on the range **Re** and the angle of optical aperture  $\varphi$ .

This formula defines a theoretical calculation of the safety distance **Rs = tan  $\varphi$  \* Re/2**; see **Tab.:5.2, Tab. :5.3** and **Fig.: 5.1**. **If the deviating effect of a reflective surface cannot be reduced or eliminated, it is necessary that this effect remains stable or, at least, that all system functions work in an acceptable and predictable way.**

#### 4.1 Electrical installation.

Use PELV power supplies, in compliance with Chap.6.4. of EN 60204-1.

If using a non-stabilized power supply, the transformer must have double insulation and adequate power, the secondary winding must not exceed 18Vac. Use a bridge rectifier, a filtering capacitor with a minimum value of 2200 $\mu$ F for absorptions up to 1A, for higher absorptions add 2200 $\mu$ F for each extra Ampere.

Connect the supply cables directly to the source and not downstream of other power or highly inductive devices.

Run the cables of the safety light curtains in dedicated raceways or where only signals run; do not use raceways already carrying power cables.

If you use two separate power supplies for Transmitter and Receiver, they must have in common 0V.

 <b>Micro Detectors</b> Italian Sensors Technology	<b>M.D. Micro Detectors</b> Strada S. Caterina, 235 41122 Modena Italy Tel. +39 059 420411 Fax +39 059 253973 www.microdetectors.com info@microdetectors.com	<b>CX0 SERIES</b> <b>LIGHT CURTAINS</b>	<b>LANGUAGE</b>
		<b>Installation and Operation Manual</b>	<b>ENGLISH</b>

Comply with the specification of the maximum length of the connection cables. Make sure that the part or parts of the metal structure on which the sensors are installed are effectively connected to the same earth ground.  
 Before inserting the connector, check that the mains voltage and the supply voltage are within the required limits, apply the connector and check again that the supply voltage has a correct nominal value and remains within the limits defined in all working conditions. Check the limits in the two extreme conditions of minimum and maximum absorption of all devices connected to the same power supply, especially if this is **not** a stabilized power supply.



**Danger!**

In order to carry out the following operations, a voltage supply to the emitter and to the receiver is necessary. Before starting this phase, make sure that the output's switching cannot lead to any danger.

Considering the wiring diagrams indicated in **Tab.: 4.2, 4.3**, provide for the basic electrical connections necessary for a proper functioning of the device. Make sure that connection for **ComER** is available. If possible, apply the stated loads to the outputs of the receiver, then properly connect the **NC-NO** input, the receiver will acquire the selected state at the power-on. **Do not** connect the **Teach** input, even if the application later needs this kind command.

Devote special attention to the **ComER** connection between emitter and receiver, must be two cables connected directly: **ComER (pin 5 of receiver and pin 2 of emitter)** and the **common (pin 3 of both)**, the length of these connections must not exceed **20m**.

**4.2 Alignment of CX0E1RP models**

Apply supply voltage and make sure that the LEDs do not indicate any error state. The green and blue LED of the two elements must be already switched on. If it blinks, it means that the supply voltage is not enough. On the Emitter, only the green and the yellow LEDs should be switched on. If also the red LED is on, it means either that an out-of-scale IR-Led driving current value of the IR LEDs has been registered as a result of an incorrect Teach-In or that a breakdown occurred.

If the red LED blinks, even at low intensity, it means that one or more IR LED have been permanently damaged.

On the Receiver, the red LED is on (at low or high intensity) if the current value registered by the Emitter is not enough to have a LIGHT state. The red LED is off if the state is LIGHT.

The yellow LED on the Receiver is always on (ON output) or off (OFF output) according to whether state is LIGHT or DARK, in combination with the NC/NO input state.

Make sure that the optical beam path is free (and stays free) and activate Teach by temporarily connecting the input to the positive voltage or to the common. The emitter sets the driving voltage of IR LEDs at minimum, then it makes it progressively increase. During this time, the yellow LED of the emitter blinks and the red LED of the receiver is on until the receiver gets in LIGHT state. Then the yellow LED of the Emitter stops blinking and stays on, whereas the red LED of the receiver turns off. If the red LEDs of the emitter and of the receiver stay on, it means that, although the IR LED current has reached its highest level, the receiver is not in a LIGHT state. Try to repeat the operation described above and if nothing changes check connections as well as distance and alignment.

After a first Teach you can align more accurately the system, for this purpose, from the current Light position, slowly turn the receiver and note the location of the two Dark position, then put the element to the middle of the angle found. Repeat this procedure for the emitter, now rerun the Teach function.

**4.3 Verify alignment for CX0 E1RP models**

Make sure that the signal level achieved with the Fine or Gross adjustment is sufficient to guarantee the stability of work. Check this by slightly changing the alignment or by urging the mechanical structure and making sure that the system remains in a light state. In case of instability rerun several times a "Fine" calibration procedure followed by an accurate mechanical alignment, then finally run the Teach required by the application.



**Indication**

A correct optical alignment with a good signal margin prevents unstable functioning of the light curtains, reduces optical interferences and reflection by shiny surfaces and guarantees better safety in general.

**4.4 Electrical drawing**

In the following tables the colours of the cables and LEDs are indicated with the abbreviations defined in IEC 60707 in English. The pin assignment is adopted following the **IEC 60947-5-2**

<b>1</b>	<b>2</b>	<b>3</b>	<b>4</b>	<b>5 *</b>
<b>BN</b>	<b>WH</b>	<b>BU</b>	<b>BK</b>	<b>GY</b>
Brown	White	Blue	Black	Grey

\* There are also cables with Green / Yellow color (GN/YL).

Some of the cables in the market may follow the pin assignment following the **DIN 47100**

<b>1</b>	<b>2</b>	<b>3</b>	<b>4</b>	<b>5</b>
<b>WH</b>	<b>BN</b>	<b>GN</b>	<b>YE</b>	<b>GY</b>
White	Brown	Green	Yellow	Grey

**Tab.:4.1**

 <b>Micro Detectors</b> Italian Sensors Technology	<b>M.D. Micro Detectors</b> Strada S. Caterina, 235 41122 Modena Italy Tel. +39 059 420411 Fax +39 059 253973 www.microdetectors.com info@microdetectors.com	<b>CX0 SERIES</b> <b>LIGHT CURTAINS</b>	<b>LANGUAGE</b>
		<b>Installation and Operation Manual</b>	<b>ENGLISH</b>

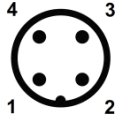
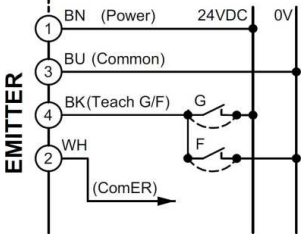
<b>CX0 SERIES</b>		<b>EMITTER</b>	<b>CX0E1 MODEL</b> Emitter with Teach-in			
<b>M12, 4 pole Male connector</b>	<b>Wiring</b>		<b>Connector</b>			
		<b>Pin</b>	<b>Color</b>	<b>Signal</b>	<b>Description</b>	
		1	BN	24V <sub>DC</sub>	Power supply input from 16.8 to 30V	
		2	WH	ComER	Connect to same signal of the receiver, maximum cable length: 20 m	
		3	BU	0V	Supply voltage reference, this pin must be tied together to the common of the receiver, maximum cable length: 20 m	
		4	BK	Teach G/F	Teach-in input: <b>GROSS</b> at 24 Vdc; <b>FINE</b> at 0V	
<b>NOTE:</b> Applying the positive or common to the Teach G/F input, the process of automatic calibration begins. If this input is permanently connected to the positive or common, calibration is performed automatically only when the sensor is switched on. During calibration, the yellow LED blinks.						



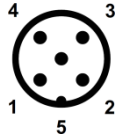
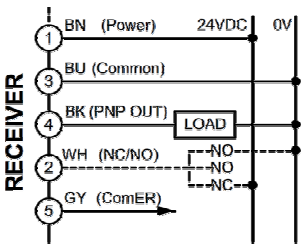

Tab.:4.2

<b>SERIE CX0</b>		<b>RECEIVER</b>	<b>CX0RP MODEL</b> Receiver with output PNP and Teach-in function			
<b>M12, 5 pole male connector</b>	<b>Wiring</b>		<b>Connector</b>			
		<b>Pin</b>	<b>Color</b>	<b>Signal</b>	<b>Description</b>	
		1	BN	24V <sub>DC</sub>	Power supply input from 16.8 to 30V	
		2	WH	NC/NO	Open or 0V: Set output normally open, Dark operate +24V <sub>DC</sub> : Set output normally closed, Light operate	
		3	BU	0V	Supply voltage reference. This pin must be tied together the common of the emitter, maximum cable length: 20 m	
		4	BK	PNP Out	Apply a load connected to the common, maximum current 100mA.	
		5	GY or GN/YL	ComER	Connect to the same signal of the emitter, maximum cable length: 20 m	
<b>NOTE:</b> The NC/NO input is read only at Power-ON.						









Tab.:4.3

#### 4.5 Panel indications and diagnostics.









Two groups of three LED indicators each (green, yellow and red) are on the front panel. The two groups provide the same indications. They are located respectively on the upper and lower part and have different signalling modes which are explained in the table here below.

MEANINGS OF LED SIGNALLING MODES			
	LED is permanently ON		LED blinks continuously
	LED ON at low intensity or intermittent with periodic blinking		LED is OFF











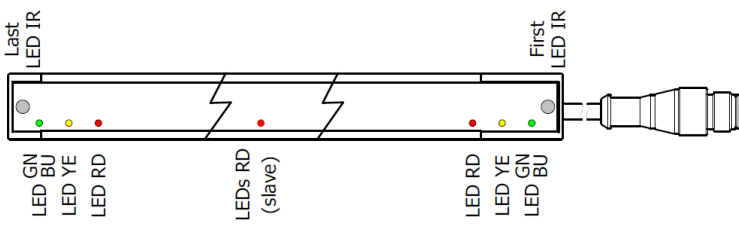

































Tab.:4.4

		CX0 EMITTERS	
<b>GN</b>		No power supply	
		Supply voltage below 15V, insufficient	
		Supply voltage above 16V, sufficient	
<b>YE</b>		Emission stopped (CX0E0 test)	
		The trimmer determines the emission (CX0E0). There is currently a Teach (CX0E1)	
		Emission enabled with the registered data (if the red LED is not on)	
<b>RD</b>		Under normal operating conditions	
		Breakdown of some IR LEDs	
		Emission turned off, calibration error or ComER wire not connected Value too high or too low	

Tab. :4.5

		CX0 RECEIVERS	
<b>GN</b>		No power supply	
		Supply voltage below 15V, insufficient	
		Supply voltage above 16V, sufficient	
<b>YE</b>		Digital output OFF	
		Digital output(s) on	
		Outputs shorted or overloaded	
<b>RD</b>		LIGHT state (all beams are free)	
		Some beams are in DARK	
		Many or all of the beams are interrupted	

Tab.:4.6

COMBINED INDICATIONS												
												
<b>EMITTER</b>						<b>RECEIVER</b>						
							<b>NO</b>	<b>NC</b>	<b>NO</b>	<b>NC</b>	<b>C.C.</b>	
<b>GN</b>	<b>BU</b>											
<b>YE</b>												
<b>RD</b>												
<b>STATE</b>												
		<b>BLOCKED OR BROKEN ComER NOT CONNECTED</b>	<b>ON TEST</b>	<b>EMISSION</b>	<b>ADJUSTMENT</b>	<b>BREAK-DOWN</b>	<b>OFF</b>	<b>DARK</b>	<b>LIGHT</b>	<b>SHORT CIRCUIT</b>		

Tab. : 4.7

 <b>Micro Detectors</b> Italian Sensors Technology	<b>M.D. Micro Detectors</b> Strada S. Caterina, 235 41122 Modena Italy Tel. +39 059 420411 Fax +39 059 253973 www.microdetectors.com info@microdetectors.com	<b>CX0 SERIES</b> <b>LIGHT CURTAINS</b>	<b>LANGUAGE</b>
		<b>Installation and Operation Manual</b>	

## 5.0 TECHNICAL SPECIFICATIONS.

CX0E*R*/**_*** MODELS		TECHNICAL SPECIFICATIONS			
PARAMETERS		Min.	Nom.	Max.	NOTES
<b>Power supply</b>					
Supply voltage	V <sub>DC</sub>	16.8	24	30	From PELV power supply according to EN 60204-1 Chap.6.4
Residual ripple	V			1.2	Supply voltage must stay within the stated limits
Absorbed power, Receiver	W	1		1.5	Excluding the load
Absorbed power, Emitter	W	1		2.5	Excluding the external trimmer
<b>Digital Outputs</b>					
Output type (CX0RP model)	N°	1xPNP			Completely protected output
Current	mA		100		Higher values are interpreted as overload or short circuit
Voltage drop @100mA	V			1.5	Reduction in output voltage compared to the supply voltage
Minimum resistive load	Ω	280			Lower values are interpreted as short circuit
Leakage current	μA			10	Value at which the OFF state of the load must be guaranteed
Tolerated capacitive load	μF			0.7	Higher values can be interpreted as short circuit.
Switching time ON	μs		0.05		With load of 220/1000Ω
Switching time OFF	μs	2		10	With load of 220/1000Ω
<b>Reaction times</b>					
Time delay before availability	ms		200		Outputs are in OFF state because the power supply has been applied
Duration of the Adjustment process (CX0E1)	s	1		15	Depending on the distance between Emitter and Receiver
DARK response time with 17 beams	ms	0.15		3.6	The more beams are darkened, the less time is needed
LIGHT response time with 17 beams	ms	0.5		5.3	It does not depend on the beams
Highest switching frequency with 17 beams	Hz			112	1 / Tlight+Tdark
DARK response time with 32 beams	ms	0.15		6.6	The more beams are darkened, the less time is needed
LIGHT response time with 32 beams	ms	1		11	It does not depend on the beams
Highest switching frequency with 32 beams	Hz			56	1 / Tlight+Tdark
<b>Input at three levels (Teach G/F)</b>					
Low level	V	0		0.8	Valid at swich-on going before through the open level
Open level	V	1.3		2.35	Always valid
High level	V	5.8		30	Valid at swich-on going before through the open level
<b>Input at two levels (NC/NO and Test)</b>					
Low or open level	V	0	open	5.8	R: Select NO (Dark ON). E: not on Test
High level	V	5.8		30	R: Select NC (Light ON). E: on Test
Integration time inputs	ms		20		The state must persist at least for the required time
<b>Input current</b>					
Input current for low level	μA	-250		520	Outgoing or incoming current
Input current for high level	mA	0.52		1.2	Incoming current
<b>Optical characteristics</b>					
See table: 2, 3, 4 and Fig. 1 of this chapter					
<b>Ambient</b>					
Artificial light immunity		Acc. to IEC 60947-5-2			It complies with limits and conditions stated in the norm
Natural light immunity		Acc. to IEC 60947-5-2			It complies with limits and conditions stated in the norm
Models with standard protection		IP67			Dust and water protection (immersion for 60 min. at a depth of 1m)
Working temperature	°C	-10		55	Without condensation
Storage temperature	°C	-25		60	To be respected also during transportation
Humidity	%			95%	Without condensation
Vibrations		Acc. to IEC 60947-5-2			It complies with limits and conditions stated in the norm
Impact		Acc. to IEC 60947-5-2			It complies with limits and conditions stated in the norm
<b>Range correction factors</b>					
Use of diverter mirrors		0.85			For each diversion with a mirror
Environmental factors		0.50 / 0.25			For the presence of dust, vapours / mist, fumes (indicative values)
<b>Connections</b>					
Cables' section	mm <sup>2</sup>		0,34		To guarantee the stated maximum length
Total length of cables for supply / output	m			100	With indicated cables' section
Length of Interconnection cables (extensions)	m			20	Length of connections ComER (a wire and common ground)
<b>Dimensions</b>					
Housing section	mm	20 (front) x 35			Painted aluminium, colour: opaque blue RAL5002
Groove for fixing	mm	2/10/6.5			Rear groove, depth / width / width of entry
Front window width	mm	15mm			Central width: 13mm; material PC
Outer closings	N°	2			Material: Black PBT + 30% GF
Closing screws	N°	2+2			2M, FE37, burnished
<b>Connectors/Cable</b>					
CX0E Models		1xM12, 4p, Male			External cable 220mm, PVC, Ø 4.7mm
CX0R Models		1xM12, 5p, Male			External cable 220mm, PVC, Ø 5mm

Tab.:5.1



CX0E*R*/05-016V MODELS (pitch 5mm)					
OPTICAL PARAMETERS		Min.	Nom.	Max.	NOTES
Nominal Operative Domain	m	0.1	3		Distance between emitter and receiver (Re)
Emitted wavelength of IR LED	nm		850		
Optics diameter	mm		2		See Fig.:5.2, Do
Aperture angle	deg		±30°		tan φ = 0.557; see Fig.: 5.1 to avoid reflections
Threshold level for Teach G			0.33		Ratio between threshold value and light status signal
Best detecting capacity with Teach G	mm		2.5		Using a rod with the specified diameter
Threshold level for Teach F			0.8		Ratio between threshold value and light status signal
Best detecting capacity with Teach F	mm		1.5		Using a rod with the specified diameter
Immunity to artificial light direct/indirect	lux		20.000/60.000		Incandescent Lamp, standard adjustment (Teach G)
Immunity to artificial light direct/indirect	lux		1.000/2.000		Incandescent Lamp, fine adjustment (Teach F)
Immunity to artificial light direct/indirect	lux		3.000/10000		Fluorescent Lamp, standard adjustment (Teach G)
Immunity to artificial light direct/indirect	lux		350/500		Fluorescent Lamp, fine adjustment (Teach F)

Tab.:5.2; refer to the models of Tab.:3.1

CX0E*R*/10-***V MODELS (pitch 10mm)					
OPTICAL PARAMETERS		Min.	Nom.	Max.	NOTES
Nominal Operative Domain model 016	m	0.3	6		Distance between emitter and receiver See Fig.:1, Re
Nominal Operative Domain model 032	m	0.5	6		Distance between emitter and receiver See Fig.:1, Re
Emitted wavelength of IR LED	nm		880		
Optics diameter	mm		4		See Fig.:1, Do
Aperture angle	deg		±15°		tan φ = 0.268; see Fig.: 5.1 to avoid reflections
Threshold level for Teach G			0.33		Ratio between threshold value and light status signal
Best detecting capacity with Teach G	mm		5		Using a rod with the specified diameter
Threshold level for Teach F			0.8		Ratio between threshold value and light status signal
Best detecting capacity with Teach F	mm		3		Using a rod with the specified diameter
Immunity to artificial light direct/indirect	lux		10.000/30.000		Incandescent Lamp, standard adjustment (Teach G)
Immunity to artificial light direct/indirect	lux		1.000/10.000		Incandescent Lamp, fine adjustment (Teach F)
Immunity to artificial light direct/indirect	lux		3.000/10.000		Fluorescent Lamp, standard adjustment (Teach G)
Immunity to artificial light direct/indirect	lux		350/1.000		Fluorescent Lamp, fine adjustment (Teach F)

Tab.:5.3; refer to the models of Tab.:3.1

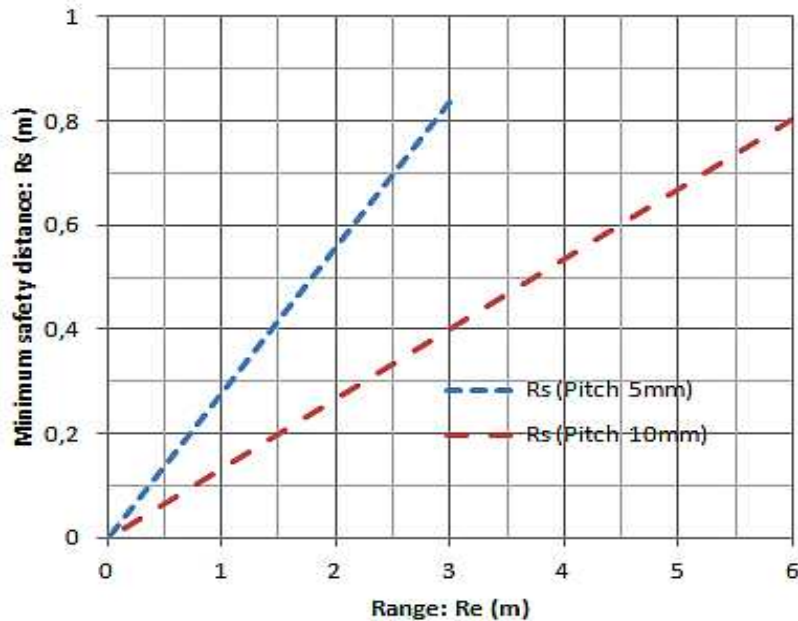

Fig.:5.1 ;  $Rs = \tan \varphi * Re/2$

## 6.0 DETECTION

### 6.1 Signal margin

With these sensors you can easily get only two levels of signal margin, with **Teach\_G: 3**; with **Teach\_F: 1.25**.

The margin **3** is usable in standard applications such as the detections of objects completely opaque and dimension larger than the optical pitch. This margin presents less pitfalls as regards the stability and repeatability of performance and is less sensitive to environmental conditions.

The margin of **1.25** is used to detect objects of size less than the optical pitch or semitransparent.

To get higher signal margin the best method is to insert a slightly opaque material, preferably close to the emitter and run a teach, then remove the opaque material; you will get a margin **3** or **1.25** multiplied by the inverse value of the transmittance of the opaque material, this method maintains the equalized margin values for all parallel and interlaced beams.

This is also the method to be used to detect objects in a translucent casing.

A coarser method is to perform a Teach with controlled conditions of misalignment and then to realign the unit without performing again a teach, however, this method does not guarantee a perfect equalization of the signal margins.

**6.2 Detection capability.**

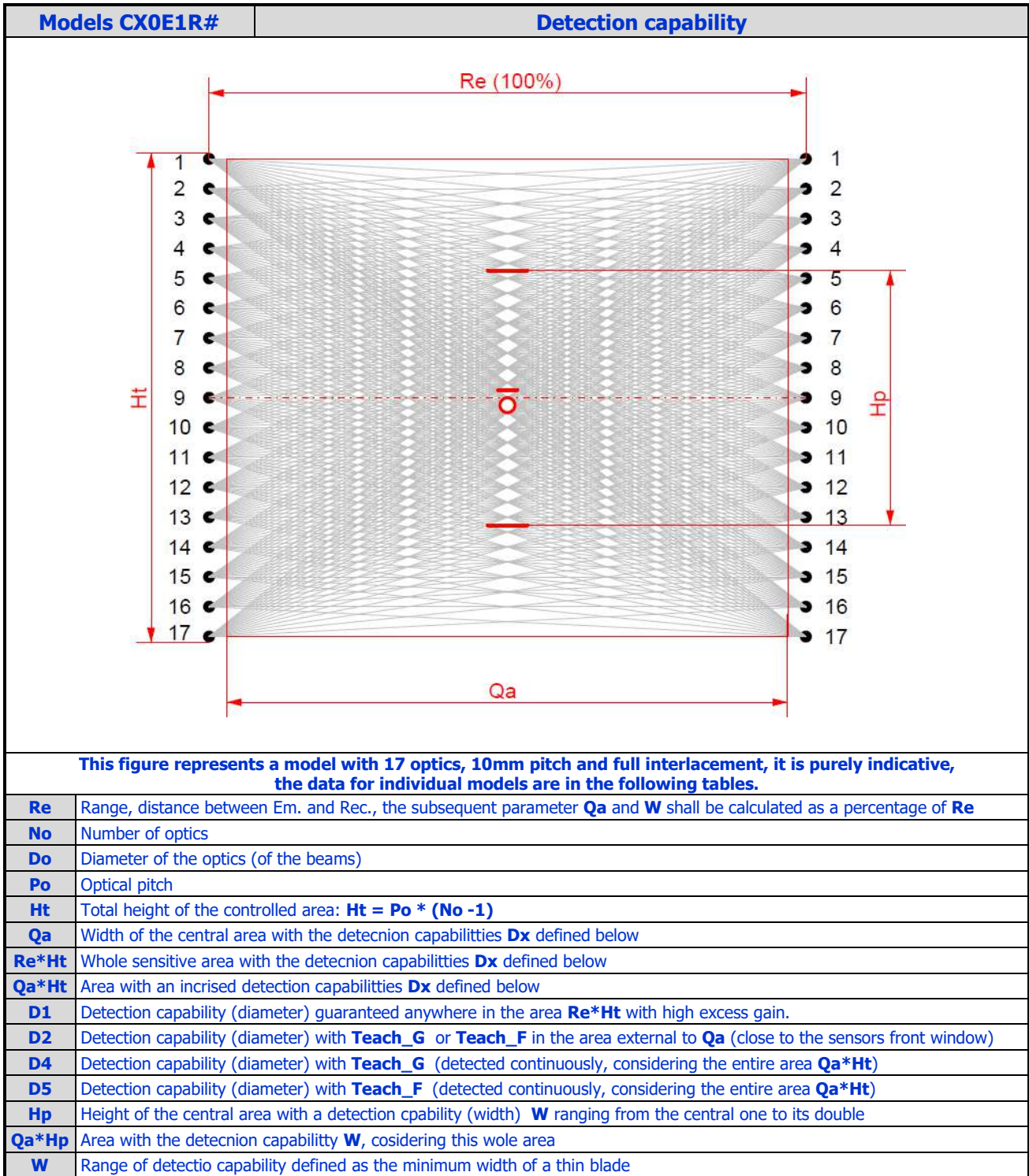

Fig.:6.1

MODEL	Beams	Optical pitch	Optical height	Horizontal central area	Vertical central area	Beam diameter	Detection capab.	Detection capab.	Detection capab.	Detection capab.	Detection capab.	NOTES
	No Nr	Po mm	Ht mm	Qa %Re	Hp mm	Do mm	D1 mm	D2 mm	D4 mm	D5 mm	W %Re	
CX0E1R#/05-016	32	5	155	96.8	83.7	2	6	5	2.5	1.5	1.61...3.22	1)
CX0E1R#/10-016	17	10	160	93.8	86.4	4	12	10	5	3	3.22...6.44	
CX0E1R#/10-032	32	10	310	96.8	167.4	4	12	10	5	3	1.61...3.22	1)

**NOTE:**

1) From the front window are visible 33 optics, but in this model the last top isn't operative.

Tab.:6.1

**7.0 MECHANICAL DIMENSIONS OF LIGHT CURTAINS AND STANDARD ACCESSORIES**

**7.1 Mechanical dimensions of CX0 light curtains**

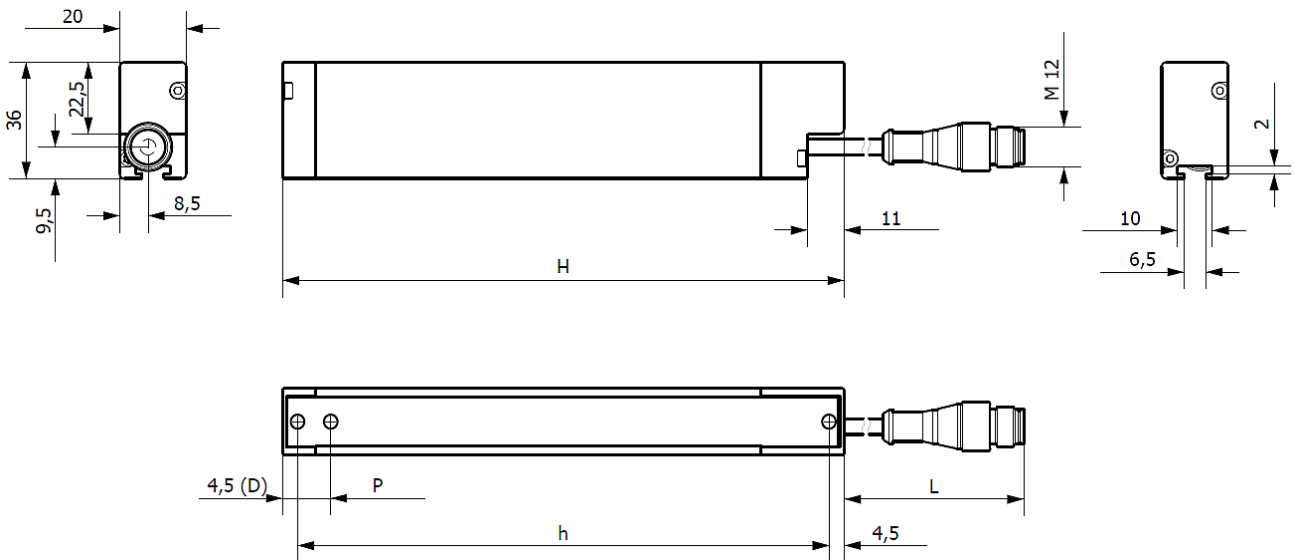

**Fig.:7.1**

For Dimensions **P**, **h** and **H** see **Tab.:3.1**

In models with optics 32, the last optics is at a distance **D = (4.5 + P)** from the edge.

Length pig-tail **L= 240mm**

**7.2 Standard Mounting accessories**

One kit is provided for models **016**, two kits are provided for models **032**

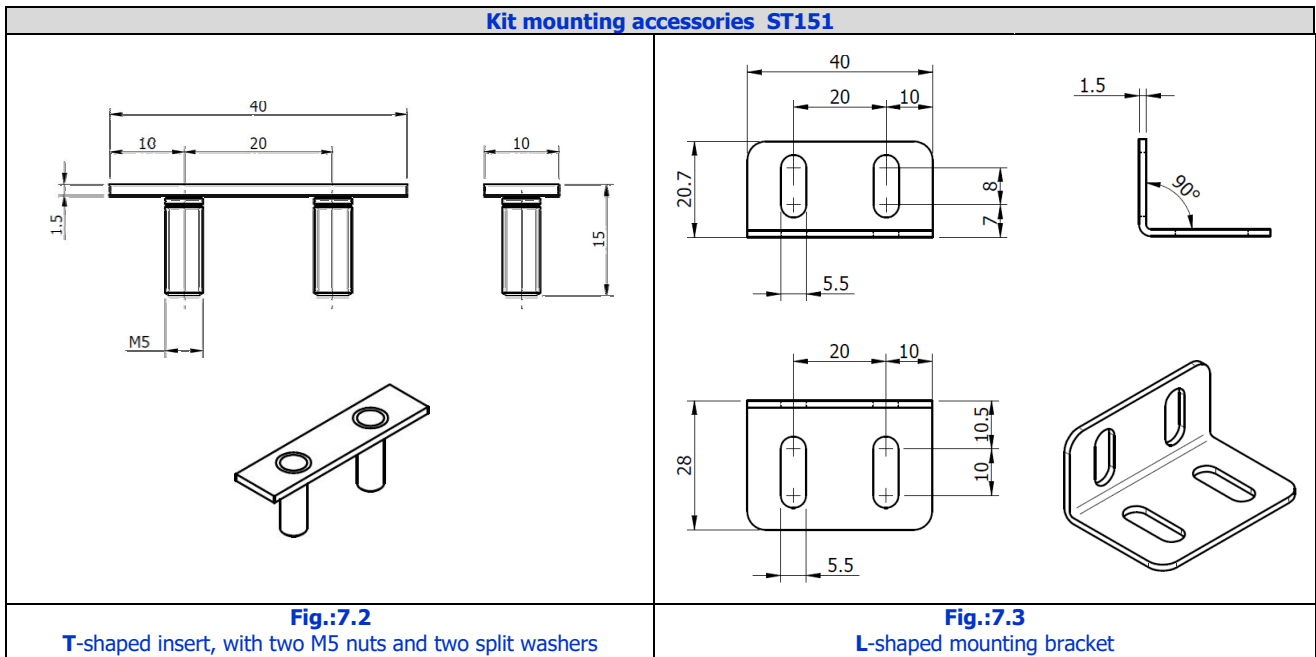

**8.0 MOUNTING OF CX0 LIGHT CURTAINS**

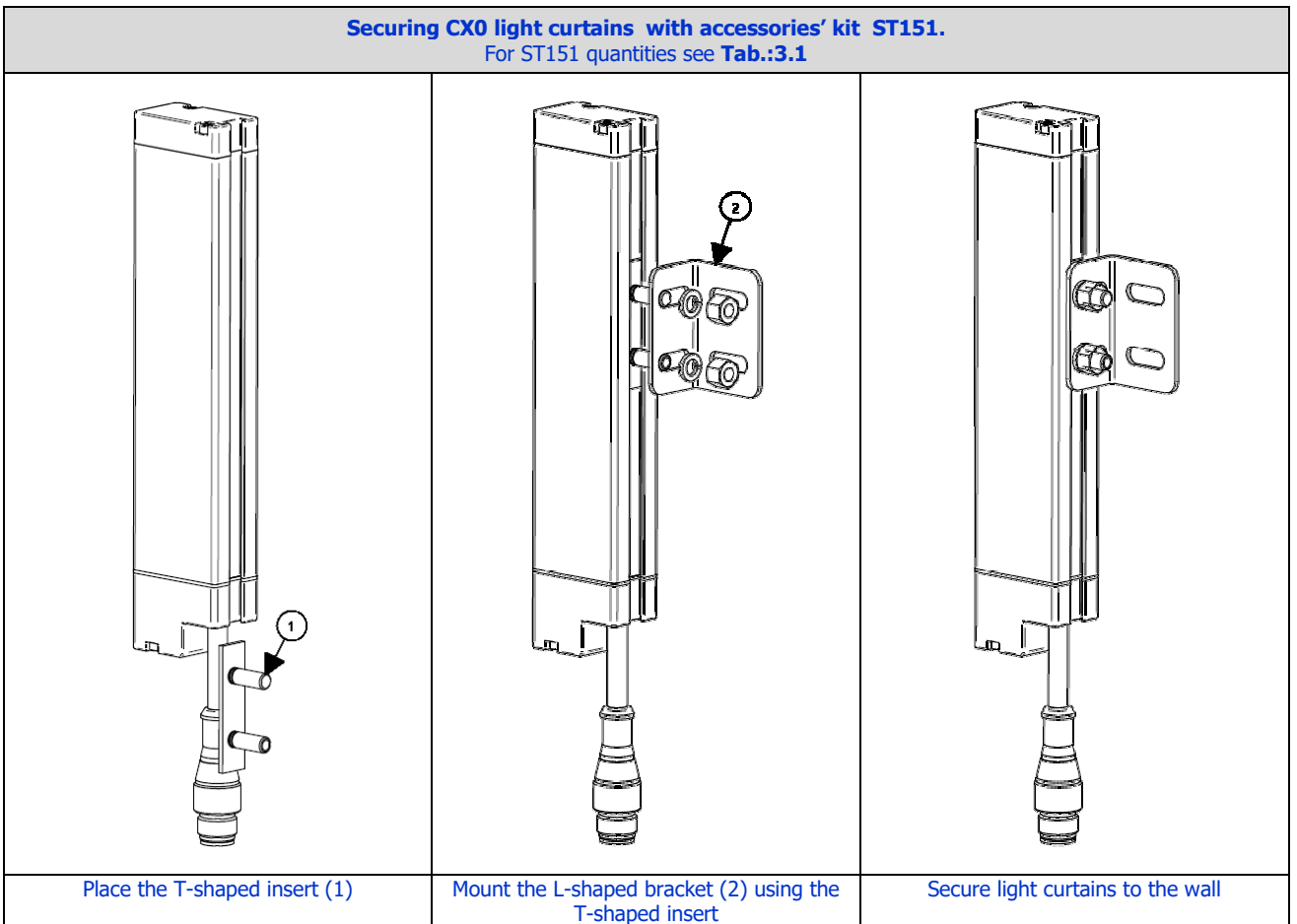

**Fig.:8.1**

 <p>M.D. Micro Detectors Strada S. Caterina, 235 41122 Modena Italy Tel. +39 059 420411 Fax +39 059 253973 www.microdetectors.com info@microdetectors.com</p>	<b>CX0 SERIES LIGHT CURTAINS</b>		<b>LANGUAGE</b>
	<b>Installation and Operation Manual</b>		<b>ENGLISH</b>

## 9.0 PACKAGE CONTENT

Each package with a kit for a light curtains' pair has the following content:

- A pair of light curtains composed of emitter and receiver.
- A number of accessories' kits ST151 (T-shaped insert and L-shaped bracket) according to the H height (see **Tab.:3.1**).
- Multilingual installation short manual.

## 10.0 CONTROL OF THE INSTALLED LIGHT CURTAINS

### 10.1 Purpose of controls.

The controls described here below are meant to ensure the functional and reliable performances required.

### 10.2 Preliminary controls before start-up

- All devices must be correctly installed and well secured.
- The maximum response time must be adequate to the application. Make sure that the sensor's response time is compatible with the specific application, detecting objects of minimum and maximum size, in different positions and, if possible, with even faster movements compared to what the application allows.
- Make sure that no optically interfering devices are in the visual field of the sensor. Make sure that other devices do not undergo interferences by the emitter.
- Make sure that sensors are not exposed to any substance which might dirty or damage the optics.
- Make sure that technical documentation is available for operators in charge of maintenance.

### 10.3 Controls of device efficiency

- State and efficiency of the device can be checked using a test stick, which must be detected in a way that is repetitive in time.
- Make sure that there are no damages nor dirt on optical windows' surface. Scratches and tarnished surfaces can negatively affect the light curtain's resolution.
- If necessary, clean the optical surface with a humid antistatic cloth. Do not use any alcohol, nor solvents, nor abrasive substances.

## 11.0 CE-CONFORMITY DECLARATION

CX0 curtains comply with the following directives and norms:

- EMC Directive **2014/30/UE**
- Harmonised norm **IEC 60947-5-2: 2007/A1:2012**
- Harmonised norm **IEC 60947-5-7: 2003**

## 12.0 WARRANTY

For every new CX light curtain, in normal using conditions, M.D. Micro Detectors guarantees the absence of defects in materials and in manufacturing for a period of **36 (thirtysix) months**.

For this period of time, M.D. Micro Detectors commits itself in eliminating any possible breakdown of the products, by repairing or by replacing the defective parts. Materials and labour are completely free of charge in this case.

M.D. Micro Detectors reserves the right to replace the whole defective device with another which is exactly the same or has equal characteristics, instead of repairing it.

Warranty is valid under the following conditions:

- the product has to be rendered within **36 months** from production date.
- The device and its components are in the same conditions in which they were delivered by M.D. Micro Detectors.
- Breakdown or malfunctioning is not directly or indirectly due to:
  - use for improper purposes;
  - no respect of instructions;
  - negligence, inexperience, incorrect maintenance;
  - repairs, modifications, adaptations not executed by M.D. Micro Detectors personnel, tampering, etc.;
  - accidents or impacts (also due to transport or force majeure);
  - other events not depending on M.D. Micro Detectors.

**The respect of all norms, indications and prohibitions contained in this document is essential to the correct functioning of light curtains.**

**Therefore, if these indications are not respected, even partially, M.D. Micro Detectors will not be held responsible under any circumstances for any possible consequence.**