

F0-08ADH-1, 8-CHANNEL ANALOG CURRENT INPUT



In This Chapter...

Module Specifications	4-2
Connecting and Disconnecting the Field Wiring	4-4
Wiring Diagram	4-5
Module Operation	4-6
Special V-memory Locations	4-7
Using the Pointer in Your Control Program	4-9
Scale Conversions	4-11
Module Resolution.....	4-14
Analog Input Ladder Logic Filter	4-15

Module Specifications

The F0-08ADH-1 Analog Input module offers the following features:

- The DL05 and DL06 will read all eight channels in one scan.
- The removable terminal block simplifies module replacement.
- Analog inputs can be used as process variables for the four (4) PID loops in the DL05 and the eight (8) PID loops in the DL06 CPUs.
- On-board active analog filtering and RISC-like microcontroller provide digital signal processing to maintain precise analog measurements in noisy environments.
- These modules are isolated from the PLC power supply logic side (1800 Volt).

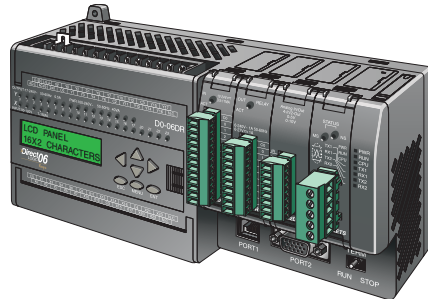

NOTE: The DL05 CPU's analog feature for this module requires **DirectSOFT32** Version 3.0c (or later) and firmware version 5.20 (or later). The DL06 requires **DirectSOFT32** version V4.0, build 16 (or later) and firmware version 2.30 (or later). See our website for more information: www.automationdirect.com.

The following tables provide the specifications for the F0-08ADH -1 Analog Input Module. Review these specifications to make sure the module meets your application requirements.

Input Specifications	
Inputs per module	8
Input Range	0-20 mA
Resolution	16-bit, 0.305 μ A/bit
Input Type	Single Ended (one common)
Maximum Continuous Overload	\pm 31mA
Input Impedance	100 ohms, 1/10W, current input
Filter Characteristics	Low pass, -3dB @ 60Hz
PLC Data Format	16-bit, Unsigned Integer, 0-FFFF (binary) or 0-65535 (BCD) [*]
Sample Duration Time	10.2 ms (time to 95% of full step change per channel)
All Channel Update Rate	81.6 ms
Open Circuit Detection Time	Zero reading within 1s
Conversion Method	Successive Approximation
Accuracy vs. Temperature	\pm 50 PPM/ $^{\circ}$ C Maximum
Maximum Inaccuracy	0.2% of range (including temperature changes)
Linearity Error (End to End)	\pm 10 count maximum; Monotonic with no missing codes
Input Stability and Repeatability	\pm 10 count maximum
Full Scale Calibration Error (incl offset)	\pm 10 count maximum
Offset Calibration Error	\pm 10 count maximum
Maximum Crosstalk at DC, 50 Hz and 60 Hz	\pm 10 count maximum
Recommended Fuse (external)	Littlefuse Series 217, 0.032 A fuse
External 24VDC Power Required	24VDC \pm 10% @ 25mA
Base Power Required (5.0 V)	25mA

^{*}Each channel requires 2 words of V-memory irrespective of the format used.

General Specifications	
Operating Temperature	0 to 55 $^{\circ}$ C (32 to 131 $^{\circ}$ F)
Storage Temperature	-20 to 70 $^{\circ}$ C (-4 to 158 $^{\circ}$ F)
Humidity	5 to 95% (non-condensing)
Environmental air	No corrosive gases permitted (EN61131-2 pollution degree 1)
Vibration	MIL STD 810C 514.2
Shock	MIL STD 810C 516.2
Field to Logic side Isolation	1800VAC applied for 1 second (100% tested)
Insulation Resistance	>10M ohms @ 500VDC
Noise Immunity	NEMA ICS3-304; Impulse 1000V @ 1ms pulse; RFI, (145MHz, 440Mhz 5W @ 15cm); Worst case error during noise disturbance is 0.5% of full scale
Agency Approvals	UL508; UL60079-15 Zone 2
Module Location	Any slot in a DL05 or DL06 System
Field Wiring	Removable Terminal Block
Weight	49g (1.7 oz.)

Connecting and Disconnecting the Field Wiring



WARNING: Before removing the analog module or the terminal block on the face of the module, disconnect power to the PLC and all field devices. Failure to disconnect power can result in damage to the PLC and/or field devices.

Wiring Guidelines

Your company may have guidelines for wiring and cable installation. If so, you should check those before you begin the installation. Here are some general things to consider:

- Use the shortest wiring route whenever possible.
- Use shielded wiring and ground the shield at the transmitter source. *Do not* ground the shield at both the module and the source.
- Do not run the signal wiring next to large motors, high current switches, or transformers. This may cause noise problems.
- Route the wiring through an approved cable housing to minimize the risk of accidental damage. Check local and national codes to choose the correct method for your application.

The F0-08ADH-1 does not supply power to field devices. You will need to power transmitters separately from the PLC.

To remove the terminal block, disconnect power to the PLC and the field devices. Pull the terminal block firmly until the connector separates from the module.

You can remove the analog module from the PLC by folding out the retaining tabs at the top and bottom of the module. As the retaining tabs pivot upward and outward, the module's connector is lifted out of the PLC socket. Once the connector is free, you can lift the module out of its slot.



NOTE: The F0-08ADH-1 analog module cannot sense the loss of analog input signals in 0-20 mA loops.

Terminal Block Specifications	
Number of Positions	13
Re-Order Number	D0-ACC-4
Pitch	0.2 inch (5.08 mm)
Wire Range	28-16 AWG Solid or Stranded Conductor; Wire strip length 5/16" (7-8 mm)
Screwdriver Size (Slotted)	0.4T x 2.5W mm (part number DN-SS1)
Screw Size	M2.5 size
Screw Torque	4.5 inch-pounds (0.52 N-m)

Wiring Diagram

Use the following diagram to connect the field wiring. If necessary, the F0-08ADH-1 terminal block can be removed to make removal of the module possible without disturbing field wiring.

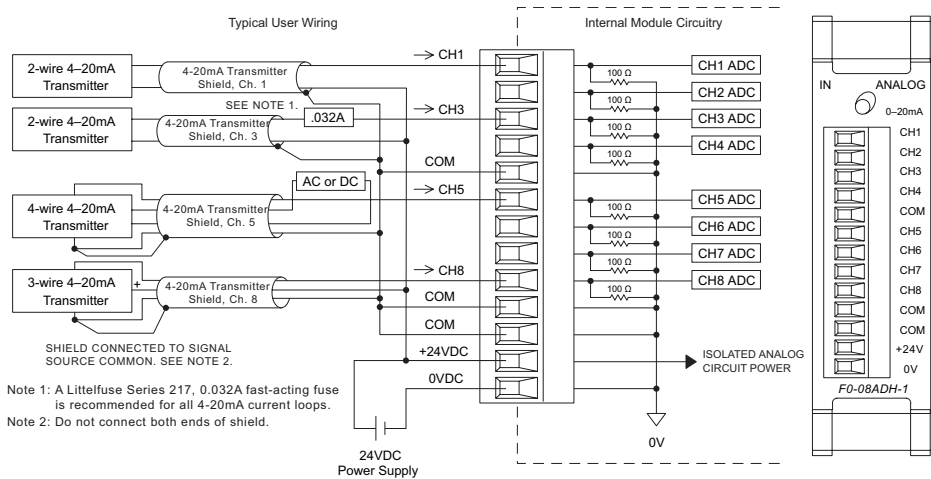

Current Loop Transmitter Impedance

Manufacturers of transmitters and transducers specify a wide variety of power sources for their products. Follow the manufacturer's recommendations.

In some cases, manufacturers specify a minimum loop or load resistance that must be used with the transmitter. The F0-08ADH-1 provides 100 ohm resistance for each channel. If your transmitter requires a load resistance below 100 ohms, you do not have to make any changes. However, if your transmitter requires a load resistance higher than 100 ohms, you need to add a resistor in series with the module.

Consider the following example for a transmitter being operated from a 30VDC supply with a recommended load resistance of 750 ohms. Since the module has a 100 ohm resistor, you need to add an additional resistor.

$$R = Tr - Mr$$

$$R = 750 - 100$$

$$R \geq 650$$

$$R = \text{Resistor to add}$$

$$Tr = \text{Transmitter requirement}$$

$$Mr = \text{Module resistance (internal 100 ohms)}$$

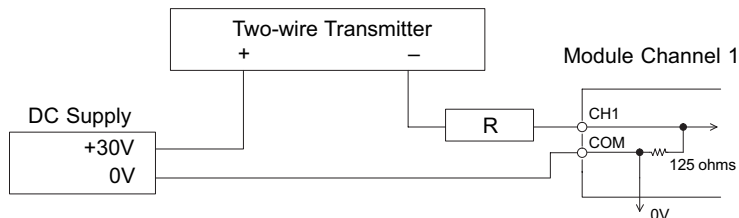

Module Operation

Channel Scanning Sequence

The DL05 and DL06 will read all eight channels of input data during each scan. Each CPU supports special V-memory locations that are used to manage the data transfer. This is discussed in more detail beginning in the section on “Special V-memory Locations”.

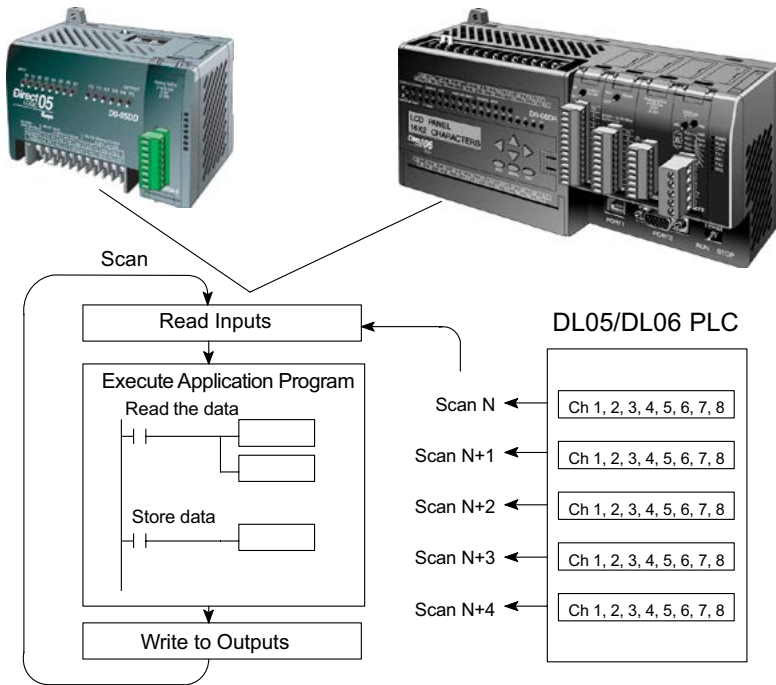

Analog Module Updates

Even though the channel updates to the CPUs are synchronous with the CPU scan, the module asynchronously monitors the analog transmitter signals and converts each signal into a 16-bit binary representation. This enables the module to continuously provide accurate measurements without slowing down the discrete control logic in the RLL program.

The module takes approximately 10.2 milliseconds to sense 95% of the change in the analog signal per channel. It takes approximately 81.6 ms to sample all channels.



NOTE: If you are comparing other manufacturers' update times (step responses) with ours, please be aware that some manufacturers refer to the time it takes to convert the analog signal to a digital value. Our analog to digital conversion takes only a few microseconds. It is the settling time of the filter that is critical in determining the full update time. Our update time specification includes the filter settling time.

Special V-memory Locations

Formatting the Analog Module Data

The DL05 and DL06 PLCs have special V-memory locations assigned to their respective option slots. These V-memory locations allow you to:

- Specify the data format (binary or BCD)
- Specify the number of channels to scan (up to 8 channels for the F0-08ADH-1)
- Specify the V-memory locations to store the input data

DL05 Data Formatting

The table below shows the special V-memory locations used by the DL05 PLC for the F0-08ADH-1.

Analog Input Module DL05 Special V-memory Locations	
Data Type and Number of Channels	V7700
Storage Pointer	V7701

Setup Data Type and Number of Active Channels

Special V-memory location 7700 is used to set the data format to either BCD or binary and to set the number of channels that will be active.

For example, assume the F0-08ADH-1 is installed in the option slot. Loading a constant of 800 into V7700 sets 8 channels active and causes the input data value to be read as a BCD number.

With the F0-08ADH-1 in the option slot, loading a constant of 8800 into V7700 sets 8 channels active, and the input data value is read as a binary number.

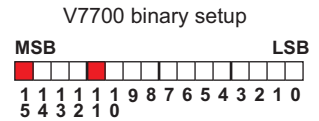
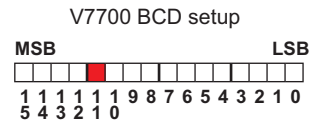

Storage Pointer Setup

V7701 is a system V-memory location used as a pointer to a user V-memory location where the analog input data is stored. The V-memory location loaded into V7701 is an octal number identifying the first user V-memory location for reading the analog input data. This V-memory location is user selectable. For example, loading O2000 causes the pointer to write Ch 1's data value to V2000 – 2001, Ch 2's data value to V2002 – 2003, Ch 3's data value to V2004 – 2005, Ch 4's data value to V2006 – 2007, Ch 5's data value to V2010 – 2011, Ch 6's data value to V2012 – 2013, Ch 7's data value to V2014 – 2015, and Ch 8's data value to V2016 – 2017.

You will find an example program that loads appropriate values to V7700 and V7701 on page 4-9.

DL06 Data Formatting

Special V-memory locations are assigned to the four option slots of the DL06 PLC. The table below shows these V-memory locations which can be used to setup the F0-08ADH-1.

Analog Input Module DL06 Special V-memory Locations				
Slot No.	1	2	3	4
Data Type and Number of Channels	V700	V710	V720	V730
Storage Pointer	V701	V711	V721	V731

Setup Data Type and Number of Active Channels

V-memory locations 700, 710, 720, and 730 are used to set the data format to either BCD or binary and to set the number of channels that will be active.

For example, assume the F0-08ADH-1 is installed in slot 1. Loading a constant of 800 into V700 sets 8 channels active and causes the input data value to be read as a BCD number.

With the F0-08ADH-1 in slot 1, loading a constant of 8800 into V700 sets 8 channels active, and the input data value is read as a binary number.

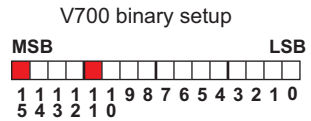
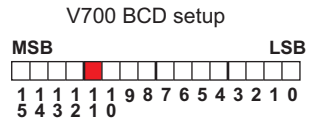

Storage Pointer Setup

V-memory locations 701, 711, 721 and 731 are special locations used as storage pointers. A V-memory address is loaded into this location as an octal number identifying the first user V-memory location for the analog input data. This V-memory location is user selectable. For example, loading O2000 causes the pointer to write Ch 1's data value to V2000 – 2001, Ch 2's data value to V2002 – 2003, Ch 3's data value to V2004 – 2005, Ch 4's data value to V2006 – 2007, Ch 5's data value to V2010 – 2011, Ch 6's data value to V2012 – 2013, Ch 7's data value to V2014 – 2015, and Ch 8's data value to V2016 – 2017.

You will find an example program that loads appropriate values to V700 and V701 beginning on page 4-10.

Using the Pointer in Your Control Program

DL05 Pointer Method Using Conventional Ladder Logic



NOTE: The proper use of the DL05 pointer requires that the V-memory address be written to the special memory location on the first scan only. Use the SPO bit as a permissive contact when using the code shown below.

The example program below shows how to setup the special V-memory locations. This rung can be placed anywhere in the ladder program or in the initial stage if you are using stage programming instructions.

This is all that is required to read the analog input data into V-memory locations. Once the data is in V-memory you can perform math on the data, compare the data against preset values, and so forth. V2000 is used in the example but you can use any user V-memory location.

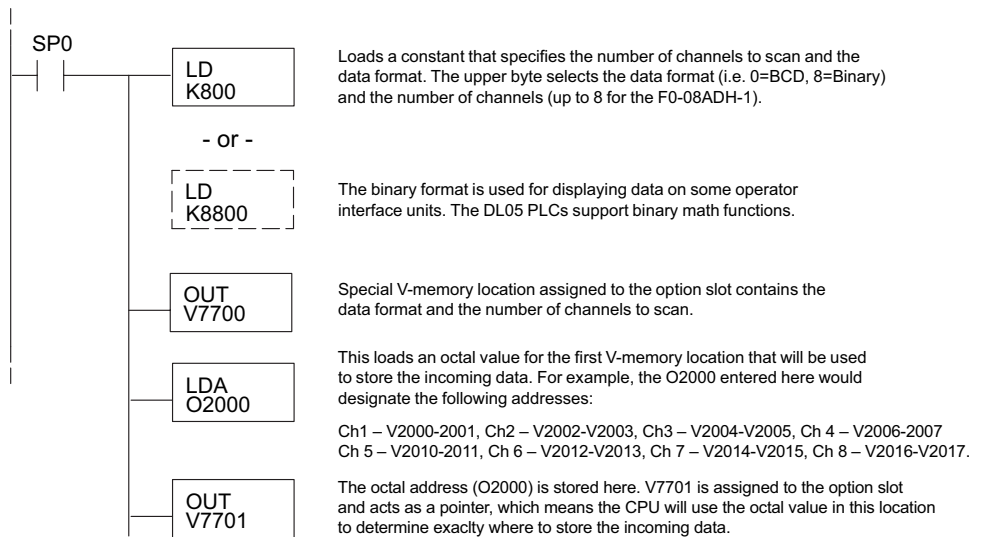

DL05 Pointer Method Using the IBox Instruction Available in DirectSOFT5

The following logic accomplishes the same thing as the previous ladder example, but it uses the IBox instruction ANLGIN.

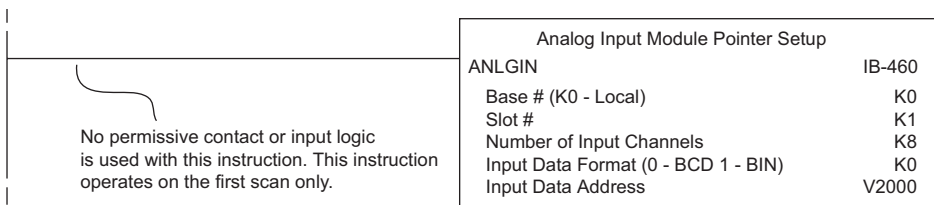

DL06 Pointer Method Using Conventional Ladder Logic



NOTE: The proper use of the DL06 pointer requires that the V-memory address be written to the special memory location on the first scan only. Use the SPO bit as a permissive contact when using the code shown below.

Use the special V-memory table below as a guide to setup the storage pointer in the following example for the DL06. Slot 1 is the left most option slot.

Analog Input Module DL06 Special V-memory Locations				
	1	2	3	4
No. of Channels	V700	V710	V720	V730
Input Pointer	V701	V711	V721	V731

The F0-08ADH-1 can be installed in any available DL06 option slot. The ladder diagram below shows how to set up these locations with the module installed in slot 1 of the DL06. Use the above table to determine the pointer values if locating the module in any of the other slot locations. Place this rung anywhere in the ladder program or in the initial stage if you are using stage programming instructions.

This logic is all that is required to read the analog input data into V-memory locations. Once the data is in V-memory you can perform mathematical calculations with the data, compare the data against preset values, and so forth. In the example, V2000 is used, but you can use any user V-memory location.

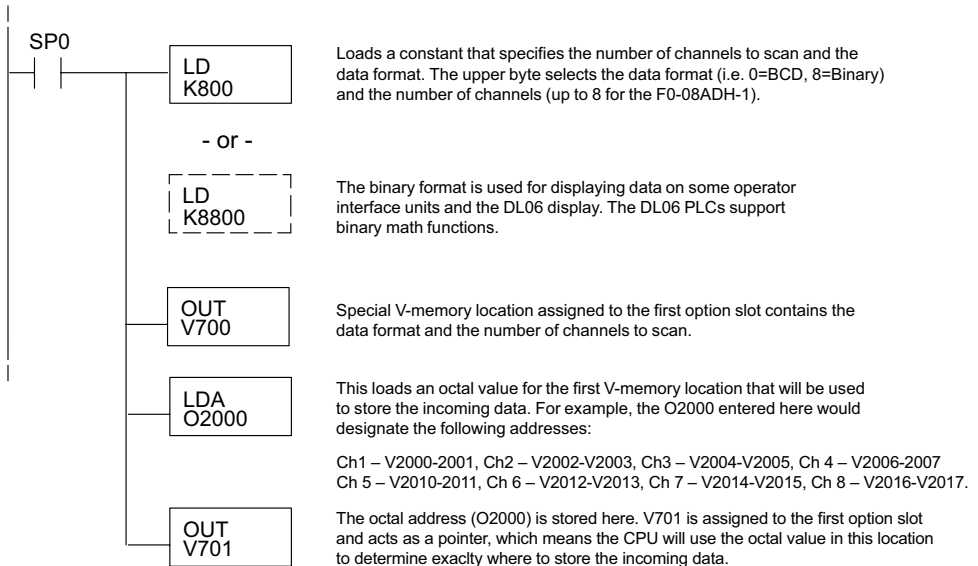

DL06 Pointer Method Using the IBox Instruction Available in DirectSOFT6

The following logic accomplishes the same thing as the previous ladder example, but it uses the IBox instruction ANLGIN.

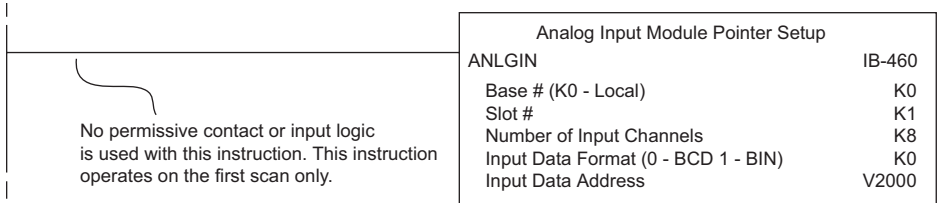

Conversions

Scaling the Input Data

Many applications call for measurements in engineering units, which can be more meaningful than raw data. Convert to engineering units using the formula shown to the right.

You may have to make adjustments to the formula depending on the scale you choose for the engineering units.

For example, if you wanted to measure pressure (PSI) from 0.0 to 99.9 then you would have to multiply the analog value by 10 in order to imply a decimal place when you view the value with the programming software or a handheld programmer. Notice how the calculations differ when you use the multiplier.

Analog Value of 32375, slightly less than half scale, should yield 49.4 PSI.

$$\text{Units} = A \frac{H-L}{65535} + L$$

H = High limit of the engineering unit range
 L = Low limit of the engineering unit range
 A = Analog value (0 – 65535)

Example without multiplier	Example with multiplier
Units = A $\frac{H-L}{65535} + L$	Units = 10 x A $\frac{H-L}{65535} + L$
Units = 32375 $\frac{100-0}{65535} + 0$	Units = 323750 $\frac{100-0}{65535} + 0$
Units = 49	Units = 494

The Conversion Program in Standard Ladder Logic

The following example shows how you would write the program to perform the engineering unit conversion. This example assumes you have BCD data loaded into the appropriate V-memory locations using instructions that apply for the model of CPU you are using.

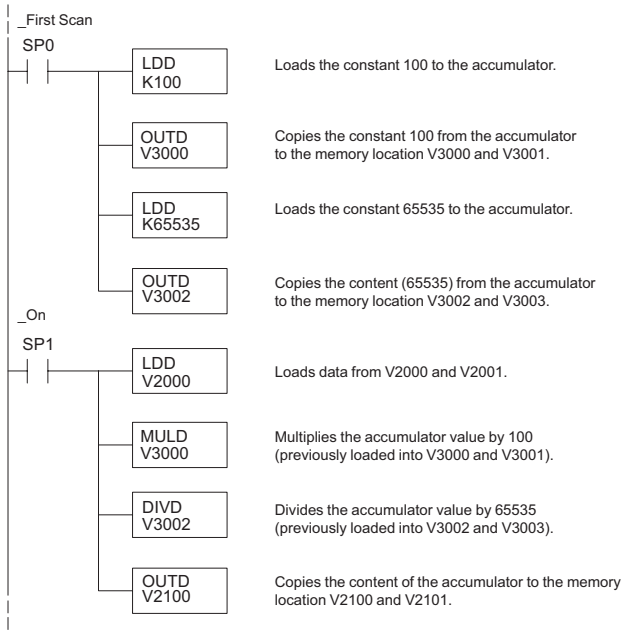

Analog and Digital Value Conversions

Sometimes it is useful to convert between the signal levels and the digital values. This is especially helpful during machine start-up or troubleshooting. The following table provides formulas to make this conversion easier.

Range	If you know the digital value	If you know the analog signal level
0 to 20mA	$A = \frac{20}{65535} \cdot D$	$D = \frac{65535}{20} \cdot A$

For example, if you have measured the signal as 10mA, you can use the formula to determine the digital value that should be stored in the V-memory location that contains the data.

$$D = \frac{65535}{20} \cdot A$$

$$D = \frac{65535}{20} \cdot 10\text{mA}$$

$$D = 32767$$

Module Resolution

Analog Data Bits

Two 16-bit words are reserved for the analog data whether you are using BCD or binary data formatting. The 16 bits in the low word represent the analog data in binary format.

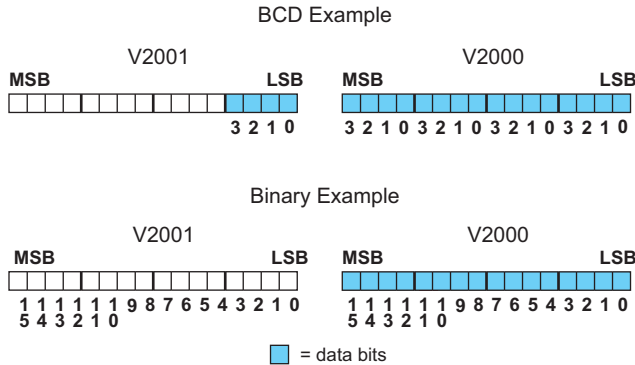

Resolution Details

Since the module has 16-bit resolution, the analog signal is converted into 65,536 counts ranging from 0 - 65,535 (2^{16}). A 0mA signal would be 0 and a 20mA signal would be 65535. This is equivalent to a binary value of 0000 0000 0000 0000 to 1111 1111 1111 1111, or 000 to FFFF hexadecimal.

Each count can also be expressed in terms of the signal level by using the following equation:

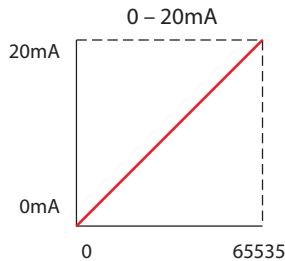

$$\text{Resolution} = \frac{H - L}{65535}$$

H = high limit of the signal range

L = low limit of the signal range

The following table shows the smallest detectable signal change that will result in one LSB change in the data value for each increment of the signal change.

mA Range	Signal Span (H - L)	Divide By	Smallest Detectable Change
0 to 20mA	20mA	65535	0.3052µA

Analog Input Ladder Logic Filter

PID Loops / Filtering

Please refer to the “PID Loop Operation” chapter in the DL06 or DL05 User Manual for information on the built-in PV filter (DL05/06) and the ladder logic filter (DL06 only) shown below. A filter must be used to smooth the analog input value when auto tuning PID loops to prevent giving a false indication of loop characteristics.

Smoothing the Input Signal (DL06 only)

The filter logic can also be used in the same way to smooth the analog input signal to help stabilize PID loop operation or to stabilize the analog input signal value for use with an operator interface display, etc.



WARNING: The built-in and logic filters are not intended to smooth or filter noise generated by improper field device wiring or grounding. Small amounts of electrical noise can cause the input signal to bounce considerably. Proper field device wiring and grounding must be done before attempting to use the filters to smooth the analog input signal.

Binary Data Format Filter Using Ladder Logic

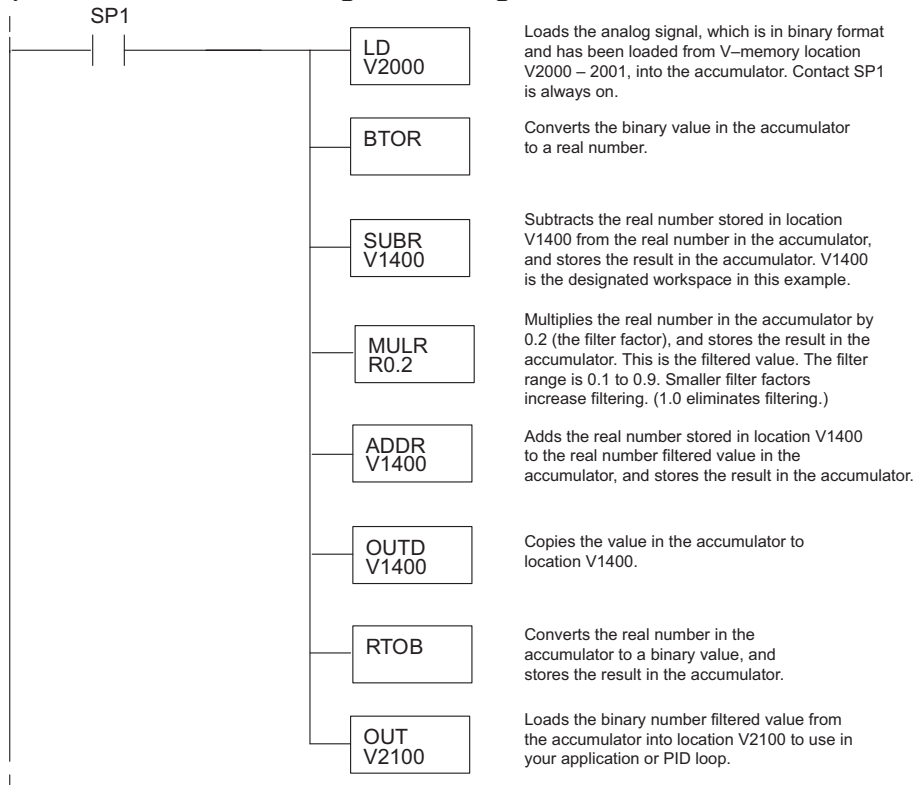



NOTE: Be careful not to do a multiple number conversion on a value. For example, if you are using the pointer method in BCD format to get the analog value, it must be converted to binary (BIN) as shown below. If you are using the pointer method in Binary format, the conversion to binary (BIN) instruction is not needed.

BCD Data Format Filter Using Ladder Logic

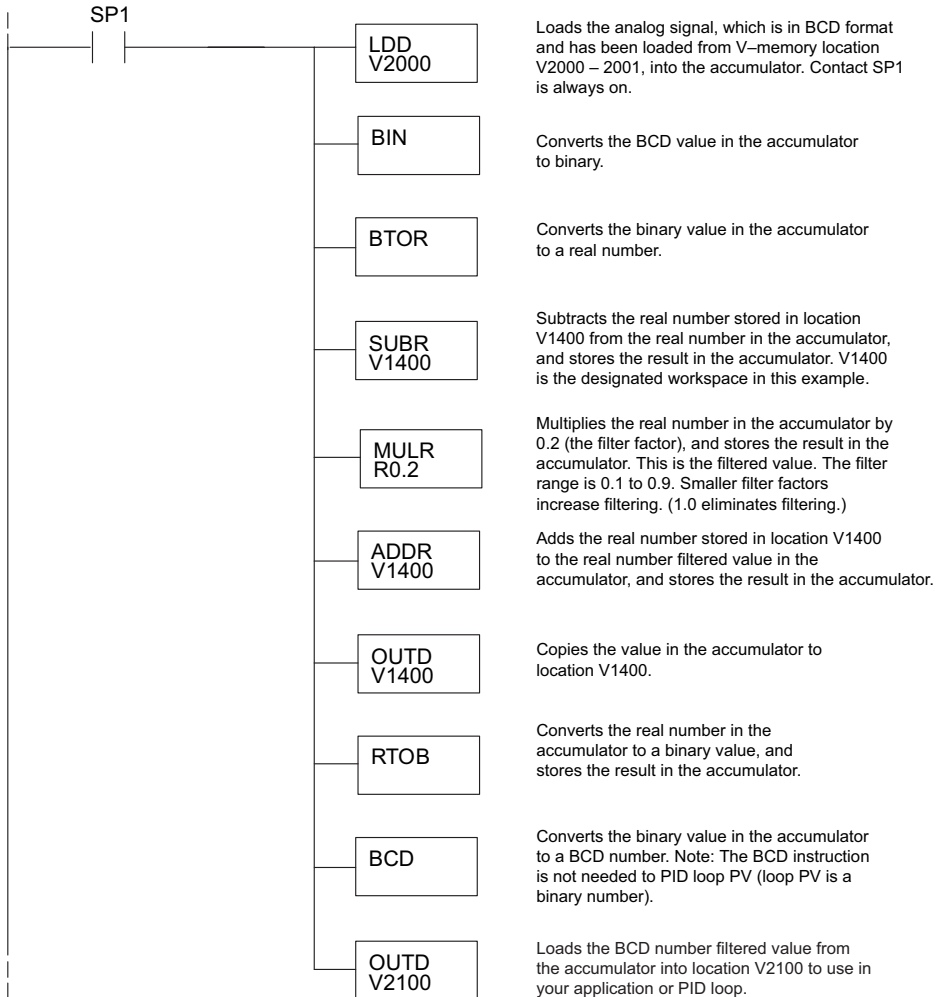

Example Code to Scale a 4–20 mA Signal to 0–1000 BCD

(For applications where the field transmitter sends a 4–20 mA signal to the analog input card.)

This example will scale the first input, a double word BCD value located at V2000 and V2001, as a 4–20 mA input signal from 0–1000. Because the input card ranges from 0–20 mA instead of 4–20 mA, an offset value must be used to deal with the 0–4 mA values. Any value below a 4mA (13107) value is forced to a 4mA (13107) value.

Load V2020 with the maximum engineering value (1000 in this example). Load V2022 with the maximum 16-bit value after the 4mA value (13107) is subtracted.

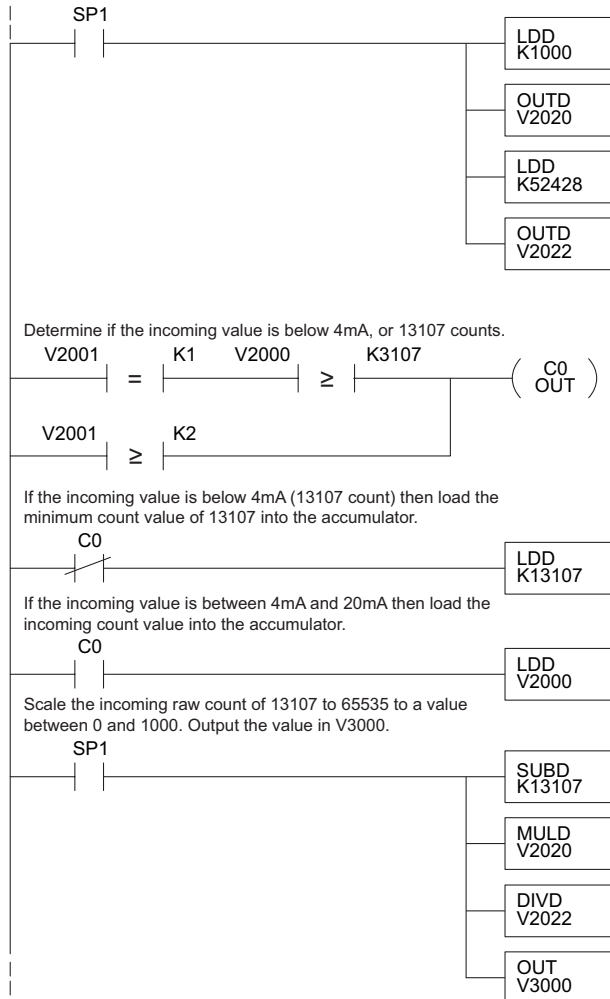

Example Code to Scale a 4–20 mA Signal to 0–1000 Binary

(For applications where the field transmitter sends a 4–20 mA signal to the analog input card.)

This example will scale the first input, a binary/decimal value located at V2000 (the CPU reserves two words for each channel so V2000 and V2001 are reserved), as a 4–20 mA input signal from 0–1000. Because the input card ranges from 0–20 mA instead of 4–20 mA, an offset value must be used to deal with the 0–4 mA values. Any value below a 4mA (13107 or 3333h) value is forced to a 4mA (13107 or 3333h) value.

Load V2020 with the maximum engineering value (1000 or 3E8h in this example). Load V2022 with the maximum 16-bit value after the 4mA value (13107 or 3333h) is subtracted.

