

# Change Preset Mode

---

## In This Chapter. . . .

- Overview
  - Setup Parameters for Change Preset Mode
  - Accessing Change Preset Variables
  - Pre-labeled Timer and Counter Presets
  - User-titled Presets
  - Combination Titles Example
  - Change Preset Password
  - Special Topics for Change Preset
  - Operator's Guide to Change Preset Mode
  - Chapter Summary
-

## Overview

### “Change Preset” Defined

**NOTE:** DV-1000s which have not had firmware upgrade to version 1.5 will not have Timer and Counter Presets **when used with DL130 and DL230 CPUs.**

Change Preset Mode allows you to view V-memory contents and change them directly from the DV-1000 keypad. We use the word “preset” because it is normally associated with process control parameters such as timer and counter presets. Historically, a “preset” is a value accessible to the operator for adjusting while the machine or process is operating. Often implemented using thumb-wheel switches, one adjusts product quality and machine performance by making a series of typically careful and incremental changes to control parameters.

The DV-1000 Change Preset Mode emulates the thumb-wheel access to adjust PLC control parameters. However, the term “*preset*” really includes all of User V-memory, not just timers and counters. This concept is so important, we emphasize it here:

**“Change Preset” means “Change V-Memory Data”!**

### How Change Preset Works

Change Preset Mode allows you to monitor and change V-memory data from the DV-1000 keypad. Refer to the figure below. The ladder program writes the setup parameters in V-memory (usually on the first scan). These contain pointers to titles (text labels for the data) and to the data itself. The DV-1000 reads these and provides access to edit the data. When the operator uses Change Preset Mode, the DV-1000 writes new values to the selected data in V-memory. Then the ladder program reads the data (usually on every scan) and uses it as a control parameter for the process.

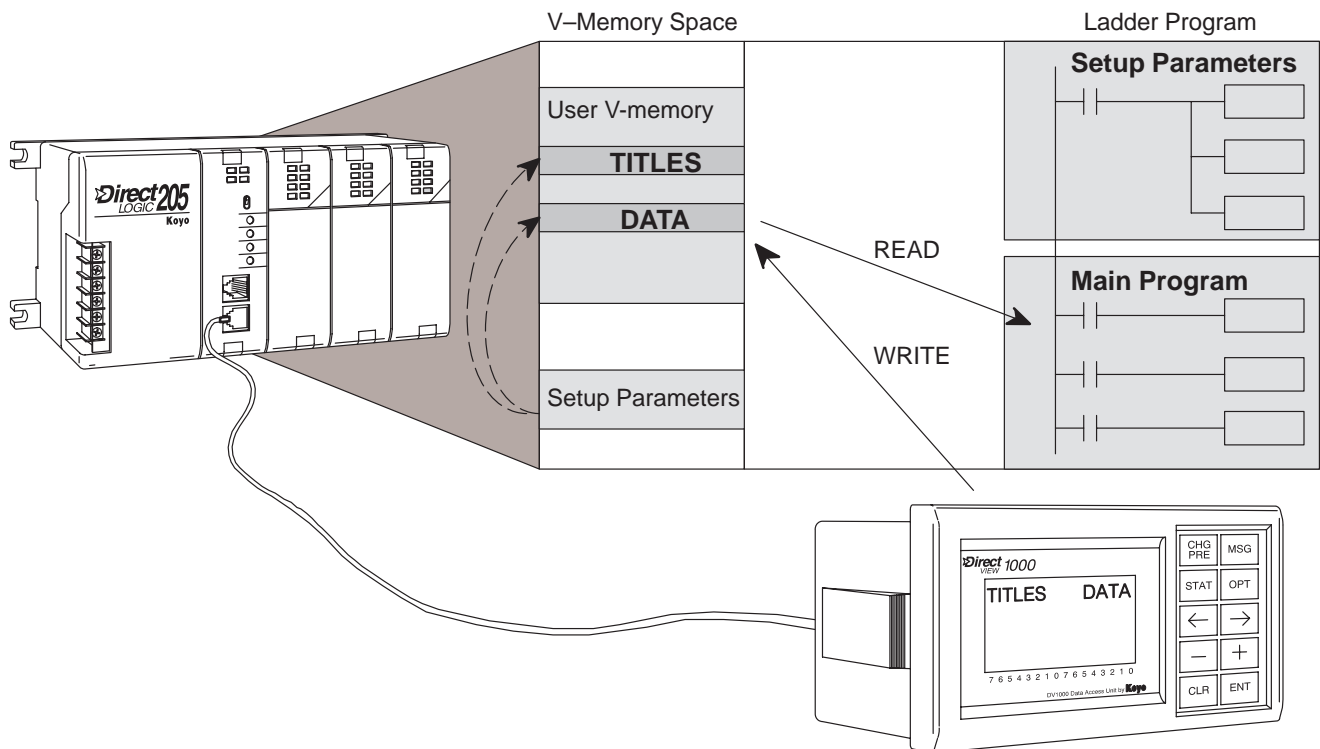

**Title and Data Fields**

Change Preset Mode presents data that you can view on the display and edit with the keypad. The display format is relatively fixed. Shown to the right, the title field on each line occupies the first eight or nine character positions. All data is presented in the right column as 4-digit BCD numbers, representing a 16-bit word.

TITLE FIELD								DATA FIELD			
a	b	c	d	e	f	g	h	0	0	0	0
a	b	c	d	e	f	g	h	0	0	0	0
a	b	c	d	e	f	g	h	0	0	0	0
a	b	c	d	e	f	g	h	0	0	0	0

7 6 5 4 3 2 1 0 7 6 5 4 3 2 1 0

You may skip creating your own titles and use default titles as shown to the right. With the setup parameter value the DV-1000 will automatically use the V-memory address for the titles.

V	2	3	0	0	3	5	8	6
---	---	---	---	---	---	---	---	---

**Preset Title Types Available**

Titles (labels) accompany the data, giving them meaning for your application. The title and data lists may be longer than the display can show at one time, but the lengths are programmable and are equal.

S	e	t	P	o	i	n	t	0	3	5	2
S	o	a	k	T	i	m	e	0	0	2	0
H	i	A	l	a	r	m	0	3	7	5	
L	o	A	l	a	r	m	0	3	2	5	

7 6 5 4 3 2 1 0 7 6 5 4 3 2 1 0

Three types of titles are available in Change Preset Mode, as shown below. User-titled Presets allow you to create your own text label of up to eight characters in length. The remaining Pre-titled Timer and Counter labels are “canned” (or fixed). However, they are convenient to use when you need generic timer or counter labels.

- 1. **User-Titled V-Memory Presets**  
(create your own text titles)

M	y	T	i	t	l	e	0	0	0	0
---	---	---	---	---	---	---	---	---	---	---

- 2. **Pre-Titled Timer Presets**  
(use canned Timer 1 to Timer 99 list)

T	I	M	E	R	1	0	0	0	0
---	---	---	---	---	---	---	---	---	---

- 3. **Pre-Titled Counter Presets**  
(use canned Counter 1 to Counter 99 list)

C	O	U	N	T	E	R	1	0	0	0	0
---	---	---	---	---	---	---	---	---	---	---	---

**NOTE:** The Pre-titled Timer and Counter Presets **only** label V-memory data on the DV-1000 display. They **do not** directly control Timer and Counter box parameters. Also, the *timer and counter preset numbering is in decimal, not in octal!*

The availability and number of title types varies with the CPU type connected to the DV-1000. Refer to table below for the availability of features for your particular CPU.

Feature	DL130, DL230, DL240	DL250, DL350, DL430, DL440, DL450
Available User-titled Presets	16	32
Available Pre-labeled Timer Preset Labels	99	99
Available Pre-labeled Counter Preset Labels	99	99

# Setup Parameters for Change Preset Mode

## Location of Preset Variable Lists

At this point we do a bit of orientation by discussing where the lists reside.

- PLC V-memory contains all the data value lists, along with User Preset titles (in ASCII code form). These lists require ladder programming, and we provide example programs in this chapter to help you do this.
- Timer titles and Counter titles are located in the DV-1000, and cannot be changed. Therefore, no programming is required for these.

The maximum number of User-titled Presets is 16 for DL130, DL230 and DL240 CPUs, and 32 for DL250, DL350 and all DL405 CPUs. A maximum of 99 Timer-titled presets and 99 Counter-titled presets are available on all systems.

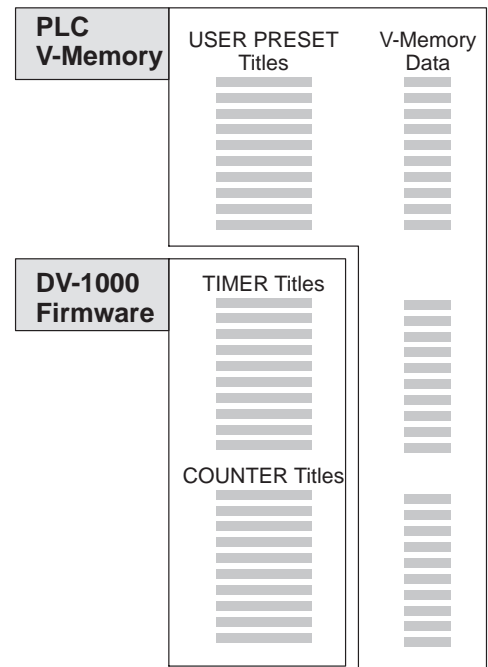

## Pointer and Block Sizes

The lists which reside in V-memory require setup parameters as well as ladder programming. The location of setup parameters is listed in the table on the following page.

Setup parameters for Change Preset Mode lists are a subset of the DV-1000 setup parameters. They include both pointer and block size types. Pointers specify the beginning addresses of each list. Block sizes are a constant that specify the length of each list *pair*.

- The length of the titles list and data list for each title type is always the same, so the block size specifies both.
- The lengths of the three types of lists may be equal, or different.

**NOTE:** Each list **must** have at least one entry. You **cannot use zero** for any of the three block size (list length) parameters.

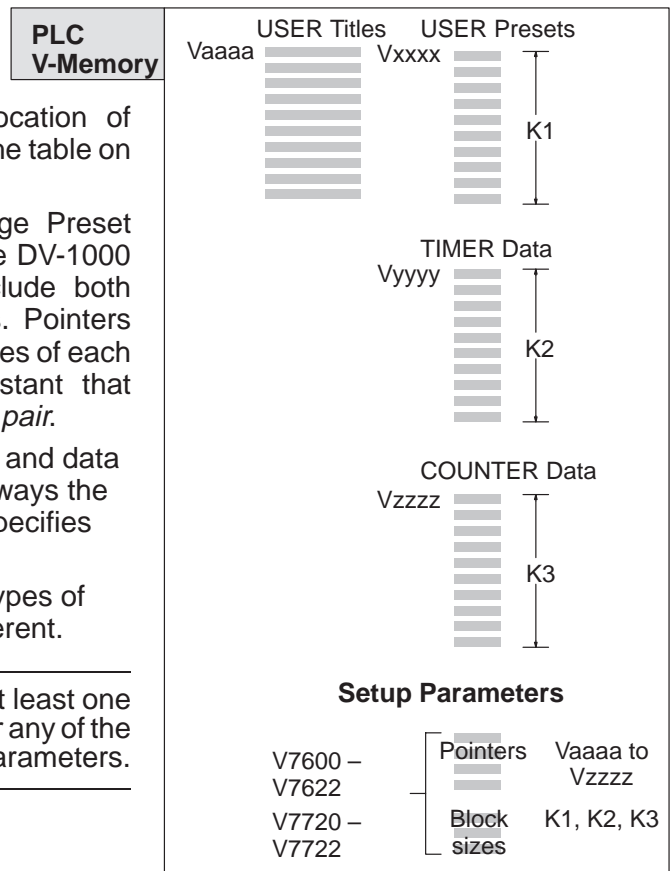

**Change Preset Setup Program**

The ladder program required to set up the DV-1000 for Change Preset Mode is very simple. In fact, the setup program needs only to execute on the first scan (use contact SP0). The things that it must do are:

- Specify the location of the titles and data.
- Specify the length of title and data lists.
- Create a password (or disable it)
- Load text data into the area for user titles, if User-titled Presets are used.

The first three of these items are part of the setup parameter location data. Later in this chapter we include several example ladder programs.

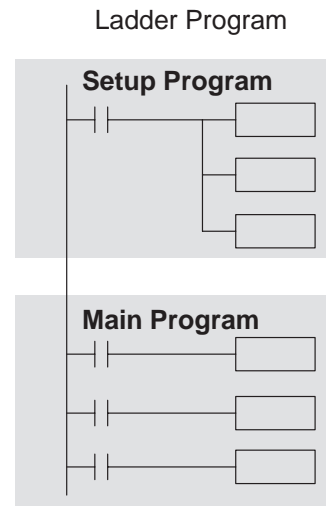

The following table lists the subset of the DV-1000 setup parameters which pertain only to Change Preset Mode.

V-Memory Location	Setup Parameter Description
V7620	User Preset Data Pointer
V7621	User Preset Titles Pointer
V7622	User Preset Block Size
V7627	Change Preset Password
V7720 (DL130 and DL230 CPUs use V7640)	Titled Timer Data Pointer
V7721 (DL130 and DL230 CPUs use V7641)	Titled Counter Data Pointer
V7722, high byte (DL130 and DL230 CPUs use Location V7642)	Titled Timer Preset Block Size
V7722, low byte (DL130 and DL230 CPUs use Location V7642)	Titled Counter Preset Block Size

The result of programming these setup parameters is shown below. The list lengths are independently programmable, as shown. The User titles text is also selectable.

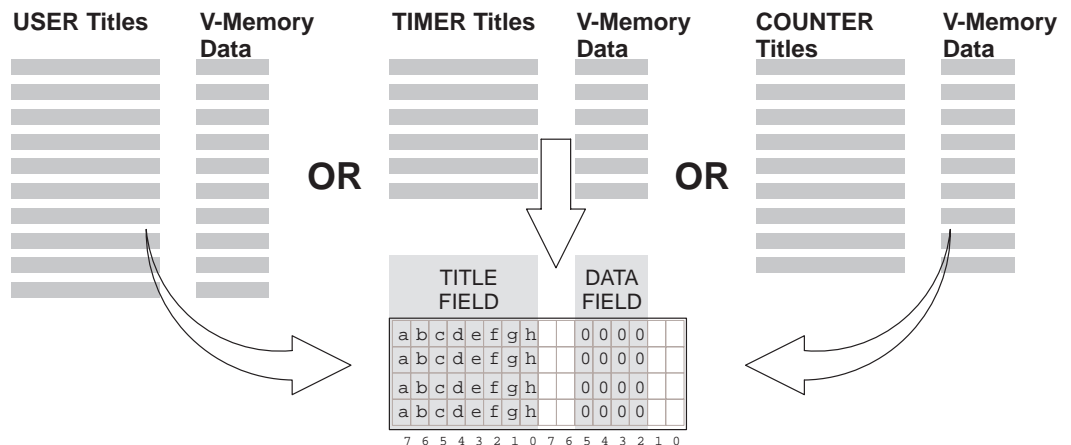

### Establishing the Lists

As a beginning example, let's program the setup parameters for the minimum list sizes and types acceptable to the the DV-1000. **The minimum length for each title list is one title each.**

USER TITLES							DATA			
M	y	T	i	t	l	e	0	0	0	0

TIMER TITLES							DATA				
							T	I	M	E	R
							1	0	0	0	0

COUNTER TITLES							DATA						
							C	O	U	N	T	E	R
							1	0	0	0	0		

Also, we can select default user titles which tell the DV-1000 to use the V-memory address for user titles instead of looking for text. This is done by using "FFFF" for the User title address pointer. A worksheet form of our Change Preset selections follows:

User Presets			Timer Presets		Counter Presets	
Text Titles	Text Locations	Data Locations	Titles	Data Locations	Counter Titles	Data Locations
(default)	-	V2300	Timer 1	V2301	Counter 1	V2302

Finally, we make some default choices just to get started. We will disable the Change Preset password for now (Change Preset Password is covered in detail further in this chapter). And, we'll choose the Powerup Default Mode to be Change Preset.

Password	Password Value	Powerup Mode	Powerup Value
Disable	0000	Change Preset	0001

Using the worksheet selections can determine the setup parameters. The numbers are in bold text in the following table. Note that the User Preset Titles Pointer will normally list an octal address. However, we program it with "FFFF" in order to select default user titles.

V-Memory Location	Setup Parameter Description	Format	Value	Notes:
V7620	User Preset Data Pointer	Octal	<b>2300</b>	Start at V2300
V7621	User Preset Titles Pointer	Octal	<b>FFFF</b>	Use default title
V7622	User Preset Block Size	BCD	<b>0001</b>	1 title
V7626	Powerup Mode	BCD	<b>0001</b>	Change Preset
V7627	Change Preset Password	BCD	<b>0000</b>	Disabled
V7720*	Timer Data Pointer	Octal	<b>2301</b>	Start at V2301
V7721*	Counter Data Pointer	Octal	<b>2302</b>	Start at V2302
V7722*	Timer Preset Block Size (high byte)	BCD	<b>0101</b>	one timer, one counter
	Counter Preset Block Size (low byte)			

\* DL130 and DL230 CPUs use different memory locations here: V7640 instead of V7720, V7641 instead of V7721, and V7642 instead of V7722.

Now we use the information in the setup parameter table to write the program. Be sure to pay attention to the data type (octal or BCD) of each instruction that loads to the accumulator. This example only requires parameter setup (no main program required). Load this program into your CPU, and *follow the discussion on the next page to see how it performs the worksheet choices.*



a:\preset1.prj

### Parameter Setup: Change Preset

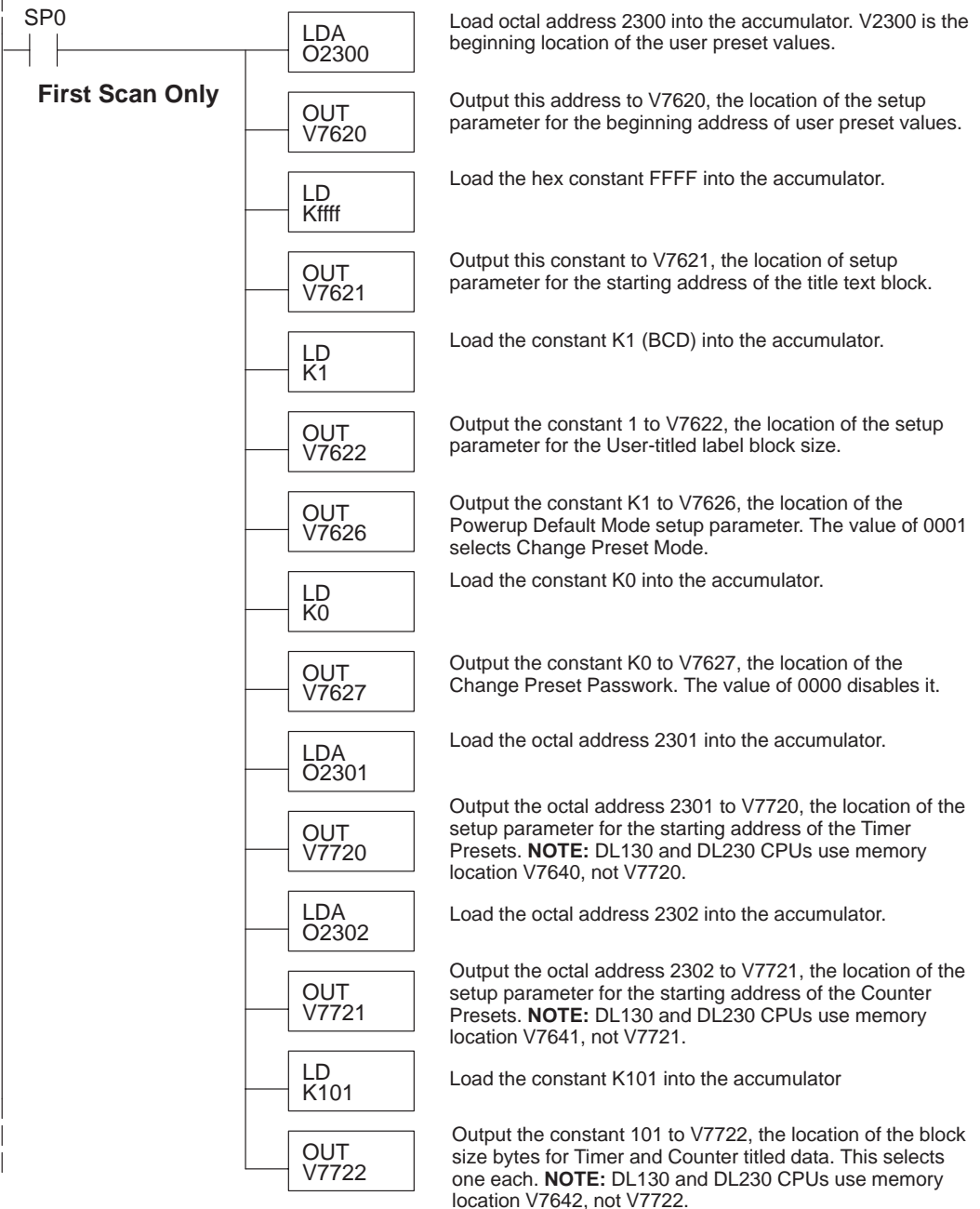

# Accessing Change Preset Variables

If you have loaded the example program in the Setup Parameters section, we're ready to see how it will perform for an operator. To enter Change Preset Mode, press **Change Preset** on the keypad. If the setup parameters for Change Preset Mode are missing or incomplete, you will see the display below on the left.

PRESS  

... **without** proper setup program

* S E T	U P	E R R O R	*																
C H E C K	V A L U E	I N																	
V 7 6 2 0	T O	V 7 6 2 2																	
7	6	5	4	3	2	1	0	7	6	5	4	3	2	1	0				

... **with** proper setup program

	V	2 3 0 0		0 0 0 0															
7	6	5	4	3	2	1	0	7	6	5	4	3	2	1	0				

## Selecting the List to Display

The three change preset lists we programmed in the first example setup program are accessible as a circular list. Refer to the figure below. Upon entry to Change Preset Mode, the first display is automatically the User-titled list. From there, use the **Right Arrow** and **Left Arrow** keys to move to the timer titles and counter titles displays.

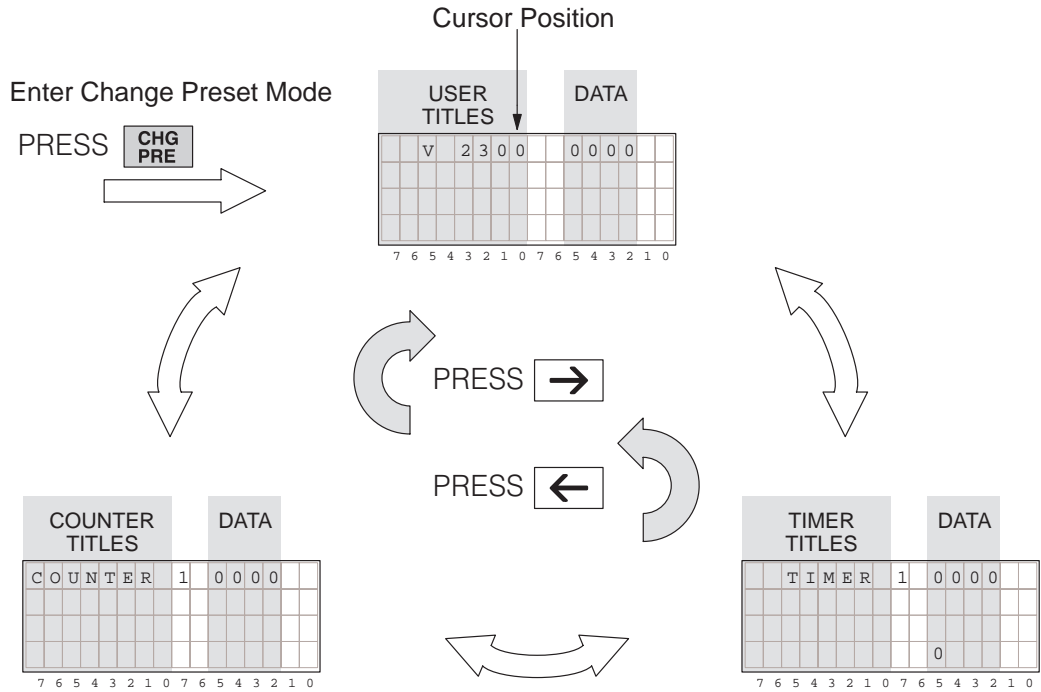



**Cursor Positioning On Title or Data**

Press the **Enter** Key to toggle the cursor from the title to the data field and back. In the title field, the cursor always occupies the right-most character position. When the cursor is in the data field you are ready to edit the data.

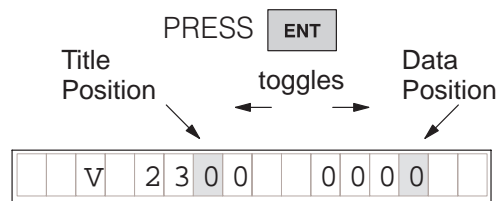

**NOTE:** Data is restricted to the range of 0000 to 9999 in Change Preset Mode. If the data you are viewing already has one or more digits in the hexadecimal range (A through F), you may only view it. The DV-1000 classifies the entire number as hexadecimal, and will not allow keypad entries to edit its value.

**Changing the Preset Value**

Once the cursor is in the data position, use the **Right** and **Left Arrow** keys to move the cursor among the four digit positions. This works in circular fashion, so moving past the end of the data jumps the cursor to the opposite end of the data value.

To increment a digit, press the **Plus (+)** Key. To decrement a digit, press the **Minus (-)** Key. The range of input change is from 0000 to 9999, BCD. Incrementing a digit past 9 or decrementing it past 0 automatically carries to or borrows from (respectively) the digit(s) to the left of the cursor position.

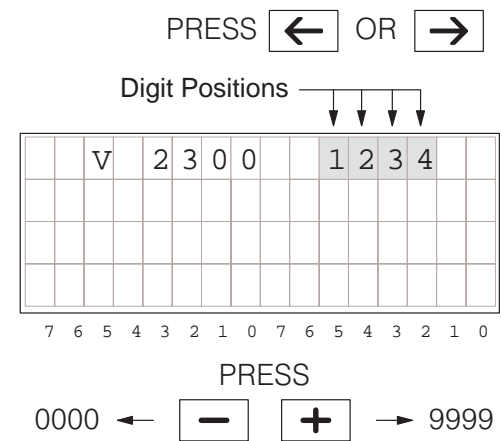

**WARNING:** Changing the preset value on the display as above immediately changes the value in PLC V-memory (the display is not buffered). Equipment damage or personnel injury may occur from improper use of this mode. Be sure to pause a moment after each keystroke to allow for the DV-1000 display update, so that you are viewing current values of Change Preset variables.

The data fields in the timer and counter displays are edited in exactly the same way as the User-titled Presets.

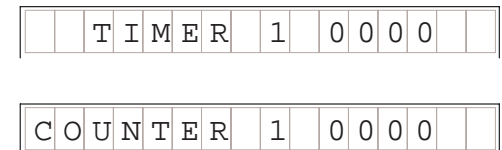

## Pre-labeled Timer and Counter Presets

Pre-labeled Timer and Counter Presets are simpler than User-titled Presets, so we discuss these first. Remember that our setup must include at least one of each title type. So, we choose one User-titled Preset, (using the default label), sixteen Pre-titled Timer Presets, and seven Pre-titled Counter Presets. The following table summarizes our selections.

User Presets			Timer Presets		Counter Presets	
Text Titles	Text Locations	Data Locations	Titles	Data Locations	Counter Titles	Data Locations
(default)		V2200	Timer 1	V2300	Counter 1	V2320
			Timer 2	V2301	Counter 2	V2321
			Timer 3	V2302	Counter 3	V2322
			Timer 4	V2303	Counter 4	V2323
			Timer 5	V2304	Counter 5	V2324
			Timer 6	V2305	Counter 6	V2325
			Timer 7	V2306	Counter 7	V2326
			Timer 8	V2307		
			...	...		
			Timer 16	V2317		

We select no password, and use Change Preset as the Powerup Default Mode.

Password Enable/Disable	Password Value	Powerup Mode	Powerup Value
Disable	0000	Change Preset	0001

Using the worksheet above we can determine the setup parameters. The numbers are in bold text in the following table.

V-Memory Location	Setup Parameter Description	Format	Value	Notes:
V7620	User Preset Data Pointer	Octal	<b>2200</b>	start at V2200
V7621	User Preset Titles Pointer	Octal	<b>FFFF</b>	default titles
V7622	User Preset Block Size	BCD	<b>1</b>	1 title
V7626	Powerup Mode	BCD	<b>0001</b>	Change Preset
V7627	Change Preset Password	BCD	<b>0000</b>	Disabled
V7720*	Timer Data Pointer	Octal	<b>2300</b>	start at V2300
V7721*	Counter Data Pointer	Octal	<b>2320</b>	start at V2320
V7722*	Timer Preset Block Size (high byte)	BCD	<b>1607</b>	16 timers, 7 counters
	Counter Preset Block Size (low byte)			

\* DL130 and DL230 CPUs use different memory locations here: V7640 instead of V7720, V7641 instead of V7721, and V7642 instead of V7722.

In this step we use the information in the setup parameter table to write the program. Be sure to pay attention to the data type (octal or BCD) of each instruction that loads to the accumulator. Load this program into your CPU, and use Preset Mode to see how it performs the worksheet choices.



a:\preset2.prj

### Parameter Setup: Change Preset

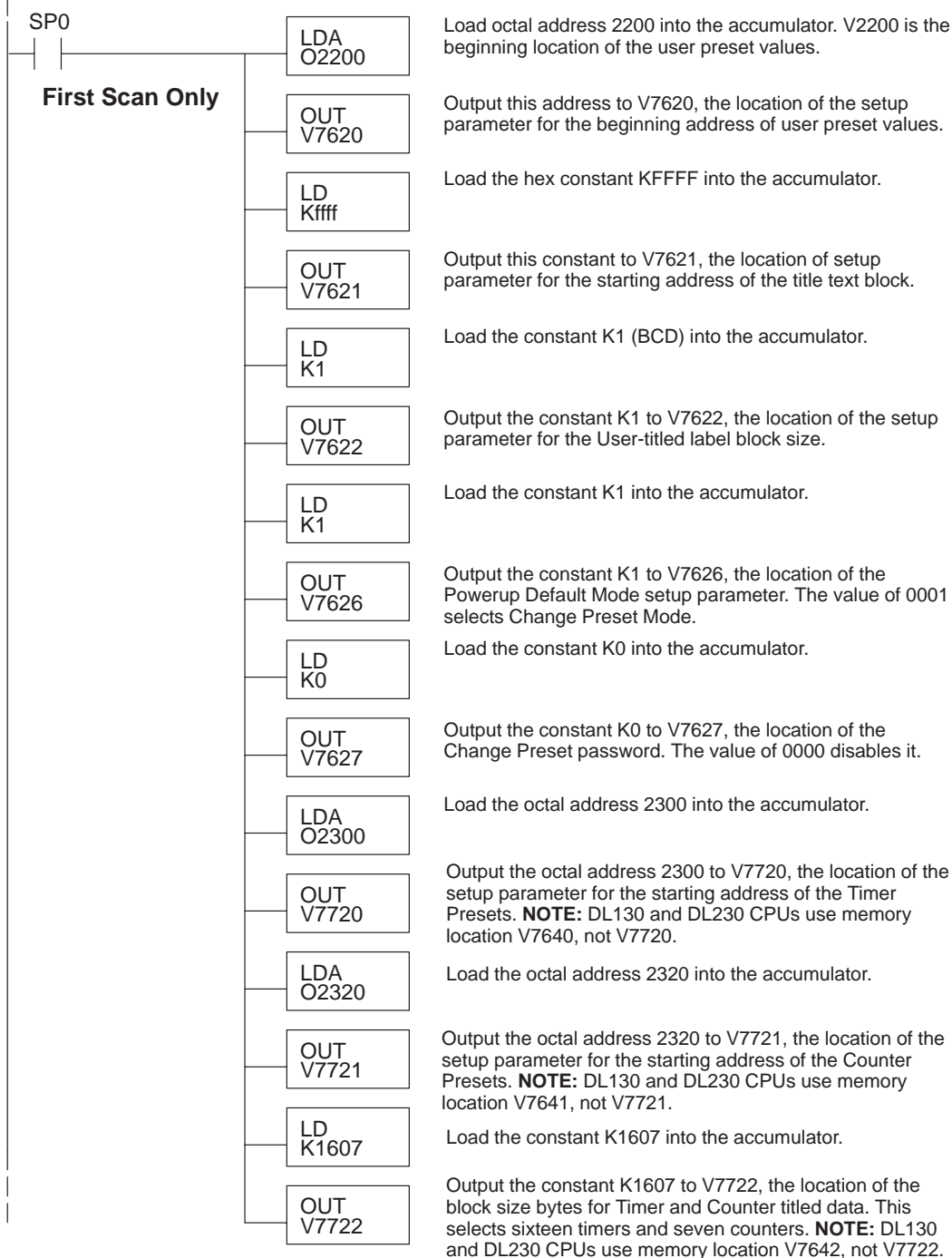

If you have loaded the Timer/Counter example program on the previous page, we're ready to see how it will perform for an operator. First, enter Change Preset Mode by pressing **Change Preset** on the keypad. Then press the **Right Arrow Key** to move to the timer titles list.

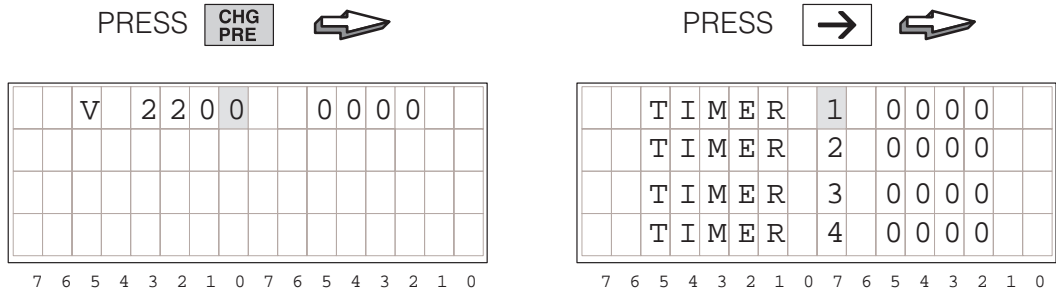

**NOTE:** In order for the new setup parameters to take effect, you must either press a key (preferably **Change Preset**), or power-cycle the PLC. Either event causes the DV-1000 to re-read its setup parameters from V-memory.

### Scrolling Through Change Preset Lists

With Timer Preset Titles selected, leave the cursor over the titles field. Then use the **Plus (+)** Key to scroll downward. By repeating this you can access all sixteen timers. Then use the **Minus (-)** Key to scroll upward through the list.

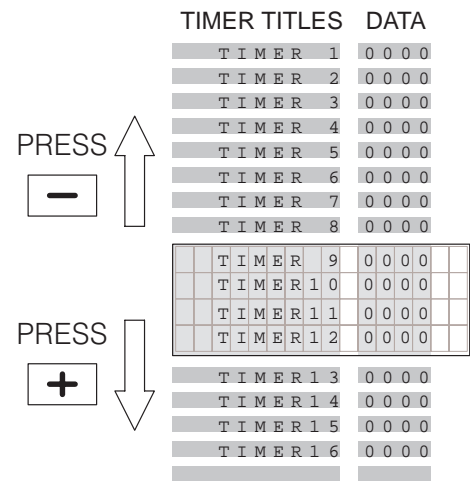
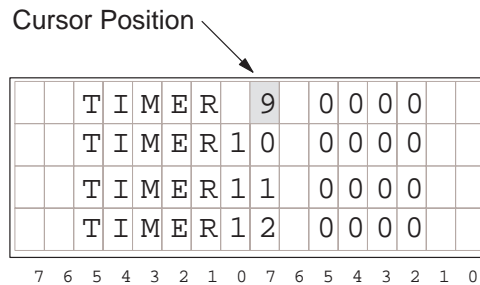

Access to Counter presets works just like timer preset labels. Press the **Cursor Right** Key to move to the counter titles display. You can then scroll through all seven counter titles by using the **Plus (+)** Key to scroll downward, and the **Minus (-)** Key to scroll upward.

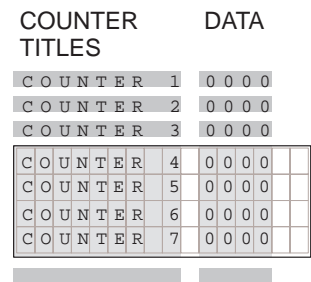

**NOTE:** Appendix C of this manual contains a worksheet for Change Preset applications. It also includes a decimal-to-octal conversion table to help correlate timer label numbers with the numbering of actual timers and counters in the CPU.

**Using Presets With Timer Box Instructions**

As mentioned at the beginning of this chapter, Timer and Counter Preset Labels serve only to label data on the DV-1000 display. These labels treat all user V-memory equally, and do not *directly* adjust ladder logic timer or counter instruction box presets. Instead, you use a common V-memory reference.

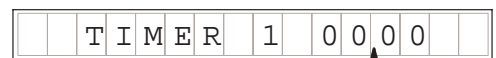

Timer Preset at V2300

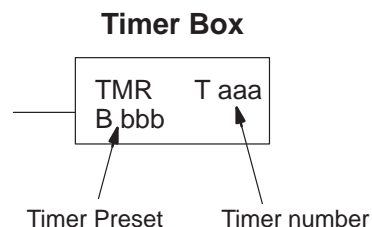

**NOTE:** The timer preset in the timer box must not be a constant Kx, if you want the Change Preset mode to adjust the timer preset!

Suppose we locate Pre-labeled “Timer 1” preset to be at V2300, as in the previous example. Now, we can associate it with an actual timer in a ladder program.

**Setup Program**

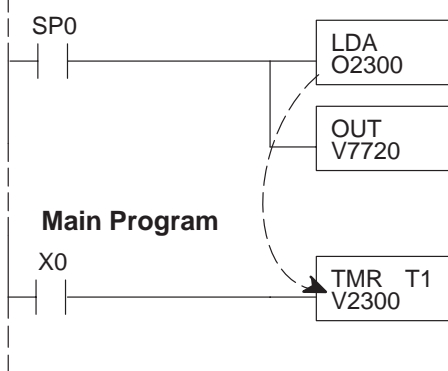

Load octal address 2300 into the accumulator.

Output this address to V7720, the location of the setup parameter for the beginning address of Timer-titled Presets.

Turn on Timer 1 when X0 is on. Enter V2300 in the preset field for the timer.

**Using Presets With Counter Box Instructions**

Suppose we locate Pre-labeled “Counter 1” preset at V2320, as in the previous example. Now, we can associate it with an actual counter in a ladder program.

**Setup Program**

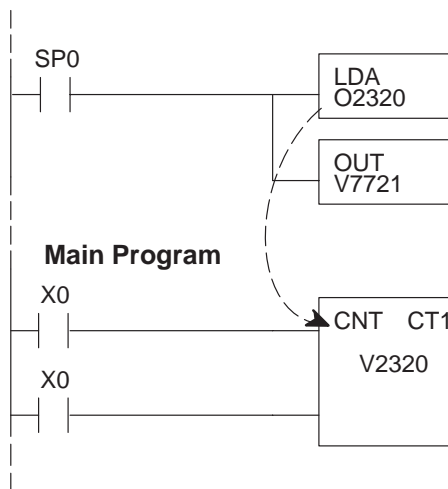

Load octal address 2320 into the accumulator.

Output this address to V7721, the location of the setup parameter for the beginning address of Counter-titled Presets.

Increment Counter 1 when X0 makes an off-to-on transition. When the counter value reaches the preset value in V2320, the counter status bit comes on. Input X1 resets the counter and turns off the counter status bit.

### User-titled Presets

#### User-Titled Text Labels

The User-titled Change Preset display allows you to create your own text titles of up to eight characters in length each. The User-title list can include from 1 to either 16 or 32 titles (depending on CPU type).

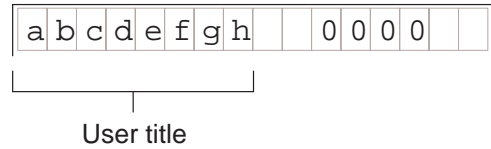

There are four display positions per title to the left of each row. The DV-1000 reserves the right side of each row for displaying the preset data, so these do not map into title text positions. Each text display position corresponds to one V-memory location, which contains two 8-bit ASCII codes. The display positions are numbered in octal, to help you reference them to corresponding V-memory addresses.

**Text Display Positions**

0	1	2	3																	
4	5	6	7																	
10	11	12	13																	
14	15	16	17																	
7	6	5	4	3	2	1	0	7	6	5	4	3	2	1	0					

**NOTE:** The complete ASCII table for the DV-1000 is in Appendix B.

Now we consider the arbitrary title “abcdefgh” on the top line of the display. We have to program V-memory with the text data in the proper location. Here are the steps:

- We choose the User-titled Preset titles starting address. Our example arbitrarily uses V2200.
- We choose a block size of one (one title). This means we reserve and program four V-memory locations for a single title.
- We use the text display position map to program the proper four V-memory locations with ASCII codes.

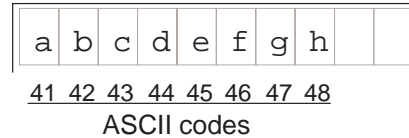

**Text Display Positions**

0	1	2	3																	
4	5	6	7																	
10	11	12	13																	
14	15	16	17																	
7	6	5	4	3	2	1	0	7	6	5	4	3	2	1	0					

**Text Data**

Position	V-Memory	Data	Text
0	2200	4142	a b
1	2201	4344	c d
2	2202	4546	e f
3	2203	4748	g h
4	2204	0000	
5	2205	0000	
6	2206	0000	
7	2207	0000	
10	2210	0000	
11	2211	0000	
12	2212	0000	
13	2213	0000	
14	2214	0000	
15	2215	0000	
16	2216	0000	
17	2217	0000	

**NOTE:** This list may be up to 16 or 32 titles long (maximum determined by CPU type). To calculate the number of V-memory locations required, just multiply the number of titles by four.

After choosing the titles and data to preset, we can fill out the following application worksheet. The four User Presets Data Locations are listed, and the text titles are left blank. Note that we have one timer and counter listed, because all three preset types must have at least one entry. Finally, we select the password (disabled) and the powerup mode. We arbitrarily choose Change Preset as the Powerup Default Mode.

User Presets			Timer Presets		Counter Presets	
Text Titles	Text Locations	Data Locations	Titles	Data Locations	Counter Titles	Data Locations
abcdefg	V2200	V2300	Timer 1	V2304	Counter 1	V2305

Password Enable/Disable	Password Value	Powerup Mode	Powerup Value
Disable	0000	Change Preset	0001

Using the worksheet above we can determine the setup parameters. The numbers are in bold text in the following table.

V-Memory Location	Setup Parameter Description	Format	Value	Notes:
V7620	User Preset Data Pointer	Octal	<b>2300</b>	start at V2300
V7621	User Preset Titles Pointer	Octal	<b>2200</b>	start at V2200
V7622	User Preset Block Size	BCD	<b>0001</b>	1 title
V7626	Powerup Mode	BCD	<b>0001</b>	Change Preset
V7627	Change Preset Password	BCD	<b>0000</b>	Disable password
V7720*	Timer Data Pointer	Octal	<b>2301</b>	start at V2304
V7721*	Counter Data Pointer	Octal	<b>2302</b>	start at V2305
V7722*	Timer Preset Block Size (high byte)	BCD	<b>0101</b>	one timer, one counter
	Counter Preset Block Size (low byte)			

\* DL130 and DL230 CPUs use different memory locations here: V7640 instead of V7720, V7641 instead of V7721, and V7642 instead of V7722.



a:\preset3.prj

**Parameter Setup: Change Preset**

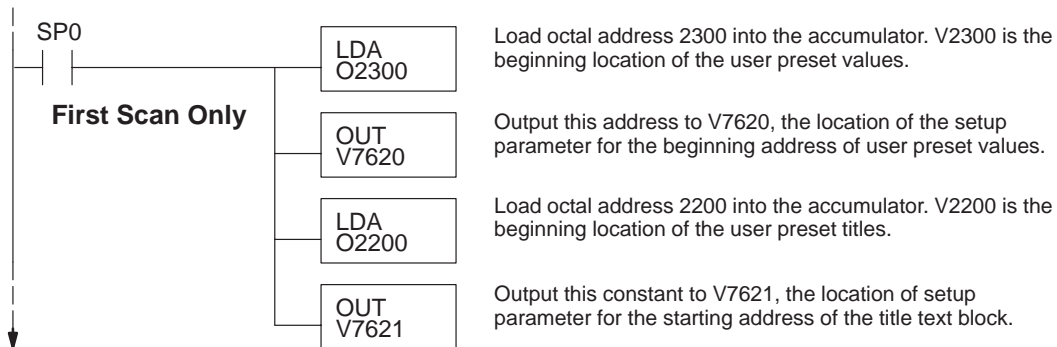

(continued)



a:\preset3.prj

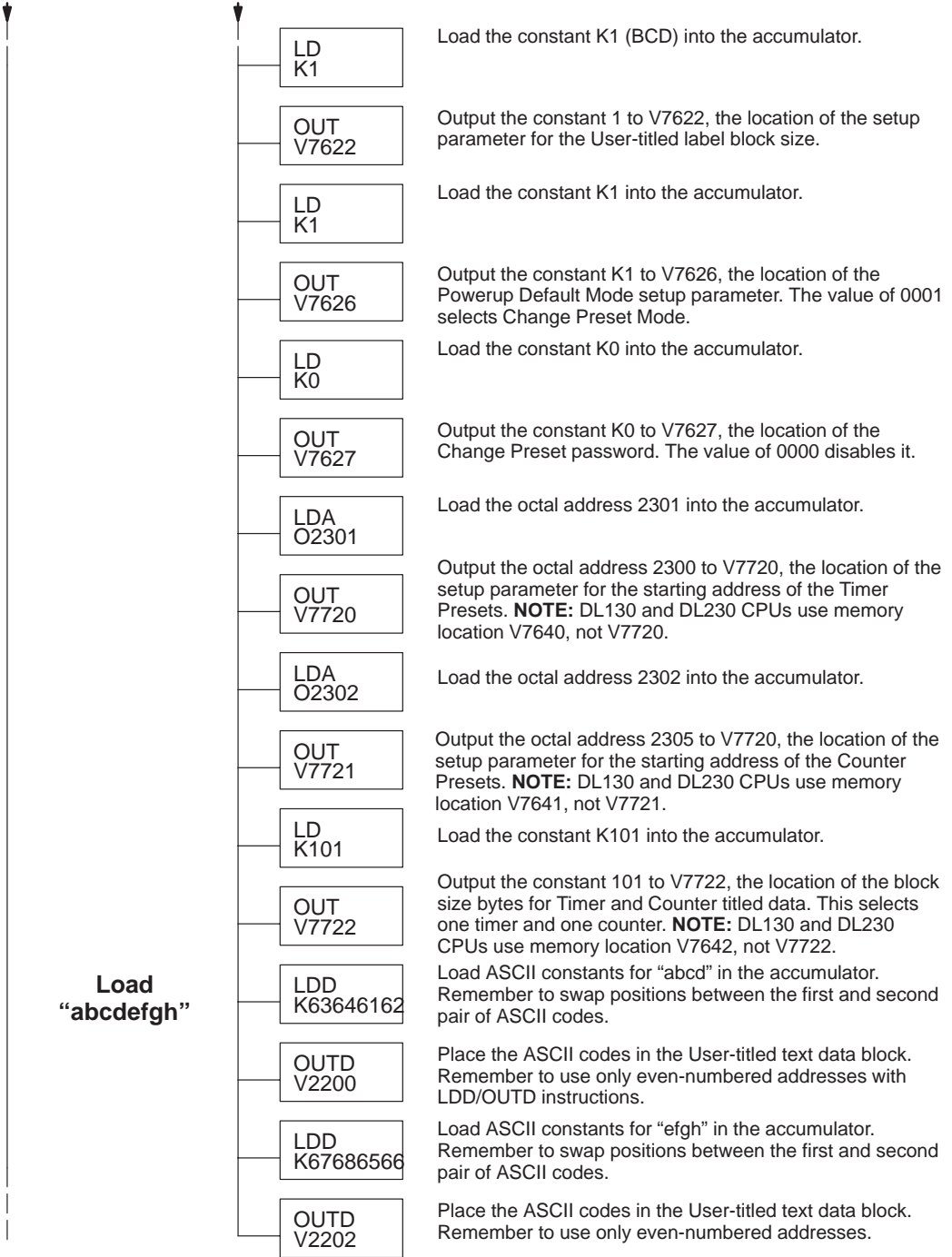

The following diagram shows the resulting displays from the program example above.

a	b	c	d	e	f	g	h	0	0	0	0				
7	6	5	4	3	2	1	0	7	6	5	4	3	2	1	0

T	I	M	E	R	1	0	0	0	0						
7	6	5	4	3	2	1	0	7	6	5	4	3	2	1	0

C	O	U	N	T	E	R	1	0	0	0	0				
7	6	5	4	3	2	1	0	7	6	5	4	3	2	1	0



**Default User Title List**

Perhaps the simplest application of Change Preset titles is the default user-titled presets. Suppose we are debugging a machine, and just want to preset four V-memory locations: V2300 – V2303. We select the default titles (Vxxx addresses) as shown to the right. This is a handy short-cut whenever it's unnecessary to invest the time in programming fancy text titles.

**Desired Display**

	V	2	3	0	0			0	0	0	0						
	V	2	3	0	1			0	0	0	0						
	V	2	3	0	2			0	0	0	0						
	V	2	3	0	3			0	0	0	0						
		7	6	5	4	3	2	1	0	7	6	5	4	3	2	1	0

**To select the default titles, just enter “FFFF” in V7621**, the setup parameter for the User-titled Preset Pointer.

The title selections are summarized in the following table. Note the inclusion of one timer and counter, because all three preset types must have at least one entry. Finally, we select the password (disabled) and the powerup mode. We arbitrarily choose Change Preset as the Powerup Default Mode.

User Presets			Timer Presets		Counter Presets	
Text Titles	Text Locations	Data Locations	Titles	Data Locations	Counter Titles	Data Locations
(V2300)		V2300	Timer 1	V2304	Counter 1	V2305
(V2301)		V2301				
(V2302)		V2302				
(V2303)		V2303				

Password Enable/Disable	Password Value	Powerup Mode	Powerup Value
Disable	0000	Change Preset	0001

Using the worksheet above we can determine the setup parameters. The numbers are in bold text in the following table.

V-Memory Location	Setup Parameter Description	Format	Value	Notes:
V7620	User Preset Data Pointer	Octal	<b>2300</b>	start at V2300
V7621	User Preset Titles Pointer	Octal	<b>FFFF</b>	use default title
V7622	User Preset Block Size	BCD	<b>4</b>	4 titles
V7626	Powerup Mode	BCD	<b>0001</b>	Change Preset
V7627	Change Preset Password	BCD	<b>0000</b>	Disabled
V7720*	Timer Data Pointer	Octal	<b>2304</b>	start at V2304
V7721*	Counter Data Pointer	Octal	<b>2305</b>	start at V2305
V7722*	Timer Preset Block Size (high byte)	BCD	<b>0101</b>	one timer, one counter
	Counter Preset Block Size (low byte)			

\* DL130 and DL230 CPUs use different memory locations here: V7640 instead of V7720, V7641 instead of V7721, and V7642 instead of V7722.



The following program example uses the previous setup table information.

### Parameter Setup: Change Preset

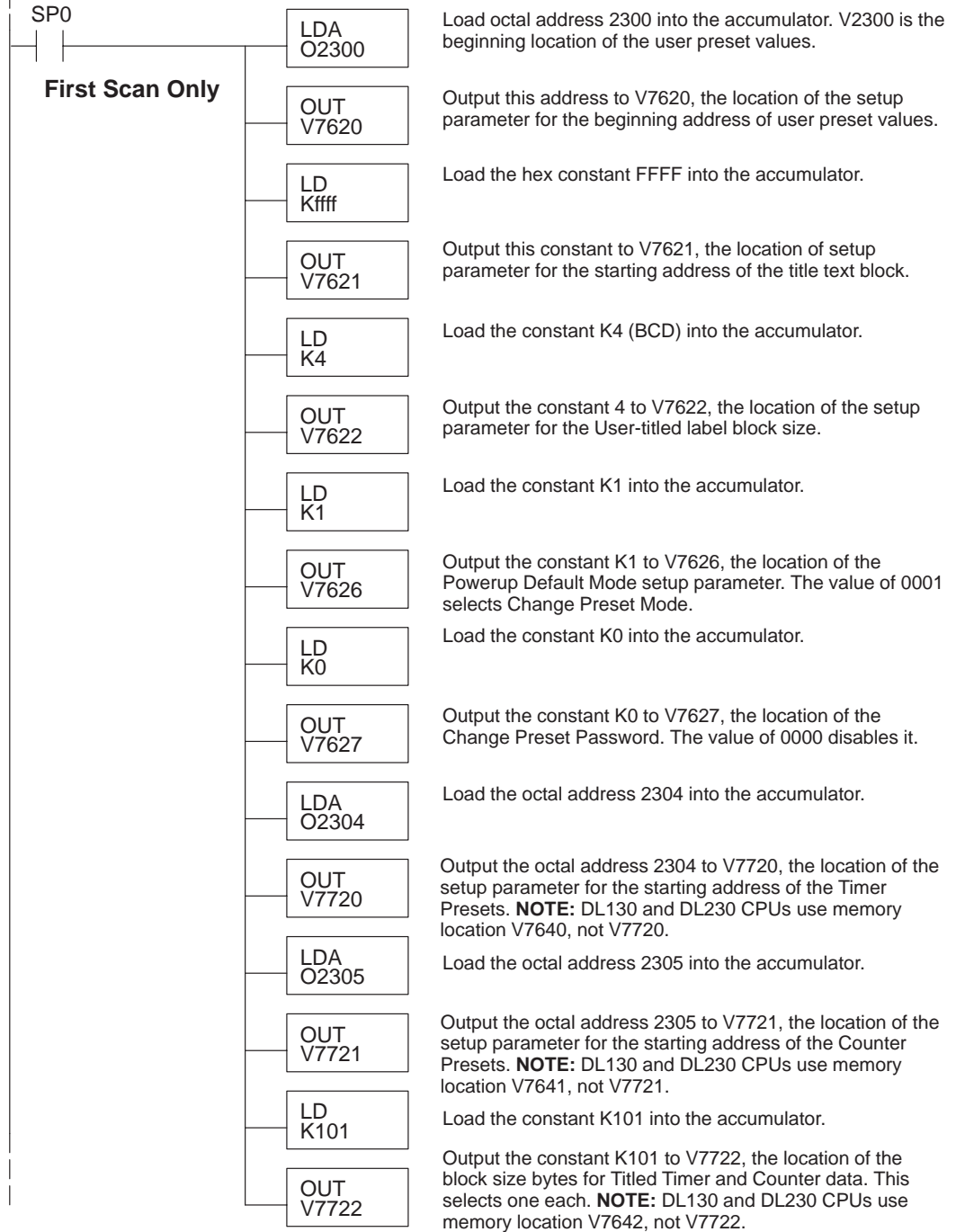

The following diagram shows the resulting displays from the program above.

V	2	3	0	0					0	0	0	0			
V	2	3	0	1					0	0	0	0			
V	2	3	0	2					0	0	0	0			
V	2	3	0	3					0	0	0	0			
7	6	5	4	3	2	1	0	7	6	5	4	3	2	1	0

T	I	M	E	R	1				0	0	0	0			
7	6	5	4	3	2	1	0	7	6	5	4	3	2	1	0

C	O	U	N	T	E	R	1				0	0	0	0	
7	6	5	4	3	2	1	0	7	6	5	4	3	2	1	0

**User-titled Text Example**

Now we will write our own User Titles, choosing meaningful names for a typical application. The list (shown to the right) is eight items long, more than the display can show at one time. However, the DV-1000 automatically adds scrolling capability. We will disable the password, and choose Change Preset as the Powerup Default Mode.

USER TITLES	DATA
SetPoint	0000
Actual	0000
Hi Alarm	0000
Lo Alarm	0000
SoakTime	0000
Temp 1	0000
Temp 2	0000
Gal / Min	0000

The following table lists our choices. The ASCII codes for the text of the User-titled Presets begins at V2200. Each title's text occupies four V-memory locations. One timer and counter are listed, just to meet the required minimum.

User Presets			Timer Presets		Counter Presets	
Text Titles	Text Locations	Data Locations	Titles	Data Locations	Counter Titles	Data Locations
SetPoint	V2200	V2300	Timer 1	V2310	Counter 1	V2311
Value	V2204	V2301				
Hi Alarm	V2210	V2302				
Lo alarm	V2214	V2303				
SoakTime	V2220	V2304				
Temp 1	V2224	V2305				
Temp 2	V2230	V2306				
Gal/Min	V2234	V2307				

Password Enable/Disable	Password Value	Powerup Mode	Powerup Value
Disable	0000	Change Preset	0001

Using the worksheet above we can determine the setup parameters. The numbers are in bold text in the following table.

V-Memory Location	Setup Parameter Description	Format	Value	Notes:
V7620	User Preset Data Pointer	Octal	<b>2300</b>	start at V2300
V7621	User Preset Titles Pointer	Octal	<b>2200</b>	start at V2200
V7622	User Preset Block Size	BCD	<b>8</b>	8 titles
V7626	Powerup Mode	BCD	<b>0001</b>	Change Preset
V7627	Change Preset Password	BCD	<b>0000</b>	Disabled
V7720*	Timer Data Pointer	Octal	<b>2310</b>	start at V2310
V7721*	Counter Data Pointer	Octal	<b>2311</b>	start at V2311
V7722*	Timer Preset Block Size (high byte)	BCD	<b>0101</b>	one timer, one counter
	Counter Preset Block Size (low byte)			

\* DL130 and DL230 CPUs use different memory locations here: V7640 instead of V7720, V7641 instead of V7721, and V7642 instead of V7722.

In this step we use the information in the setup parameter table to write the program. The first portion programs the setup parameters. The second portion writes the User-Titled text data using MOVEMC and ACON boxes. See the Message Display Mode chapter for information on how these instructions work, if necessary.



a:\preset5.prj

### Parameter Setup: Change Preset

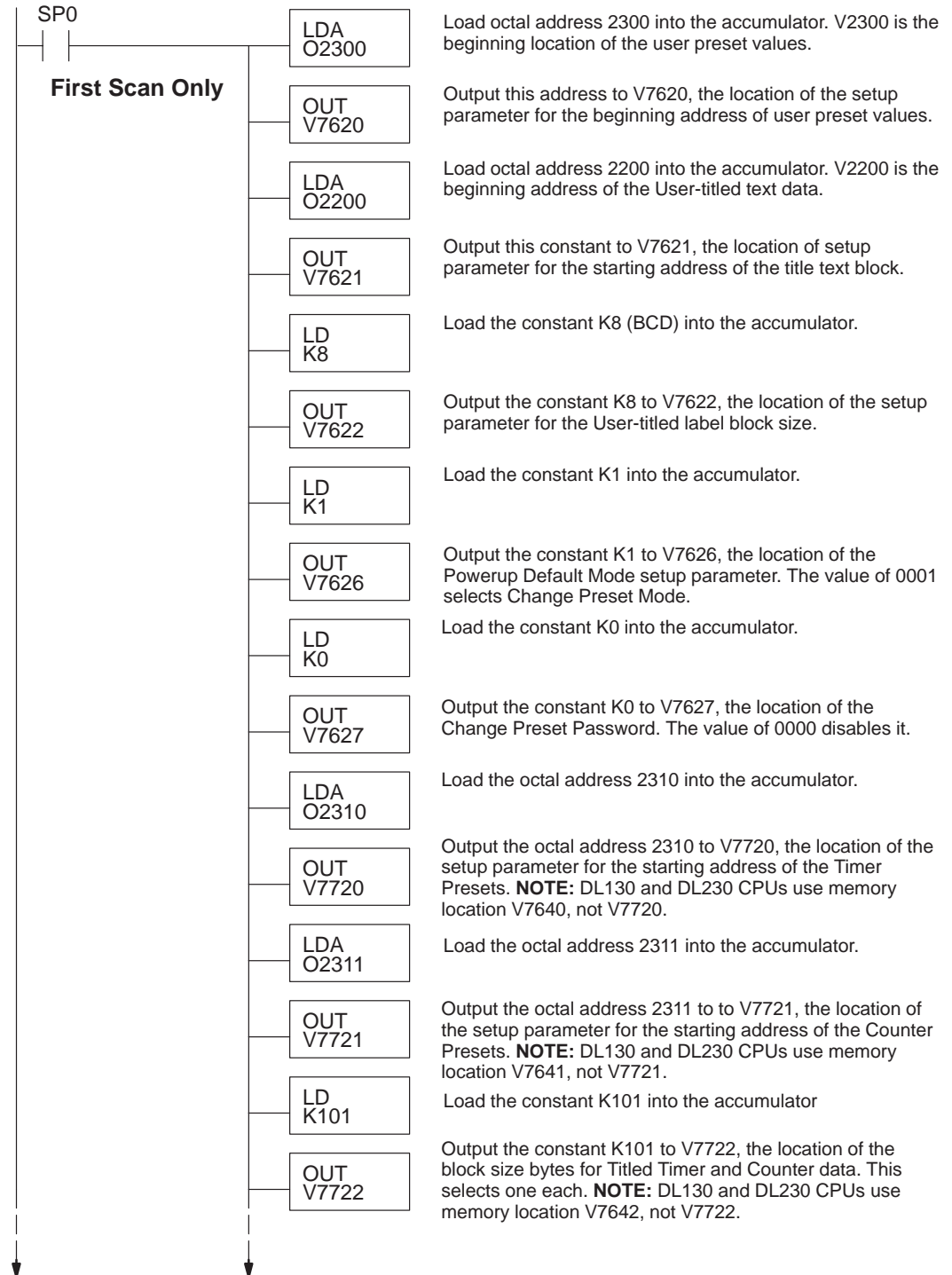

(continued)



a:\preset5.prj

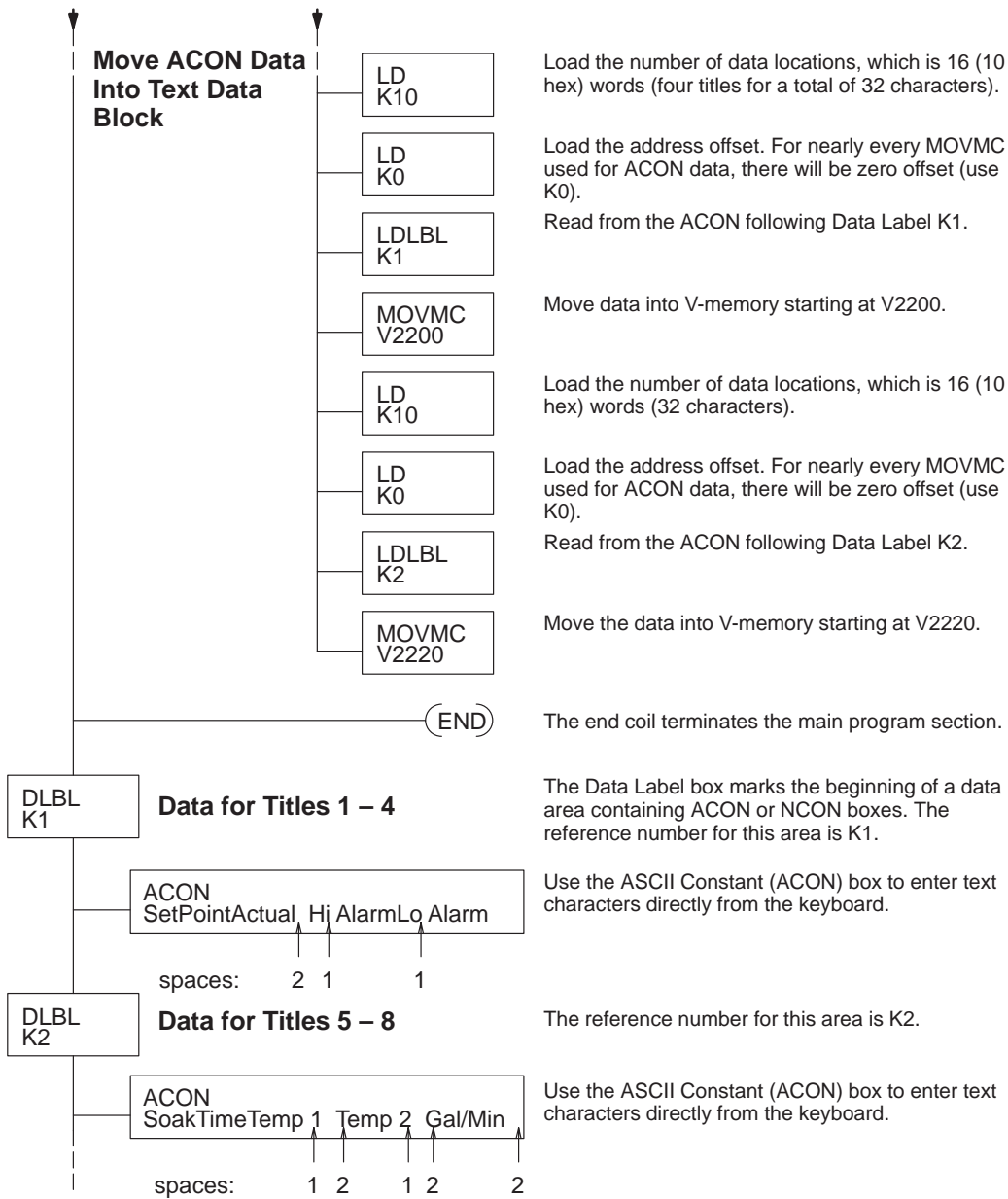

The following diagram shows the resulting displays from the program above.

Setpoint	0000
Actual	0000
Hi Alarm	0000
Lo Alarm	0000
SoakTime	0000
Temp 1	0000
Temp 2	0000
Gal/Min	0000

TIMER	1	0000					
7	6	5	4	3	2	1	0
7	6	5	4	3	2	1	0

COUNTER	1	0000					
7	6	5	4	3	2	1	0
7	6	5	4	3	2	1	0

### Individual Default User Titles

The User-titled presets also provides an option that lets you have custom titles and the default (Vxxx) titles. The setup for this is just as if all the titles are custom. However, if all the ASCII codes (4 word locations) for any title(s) is all zeros, then the DV-1000 substitutes the default title instead.

Desired Display

S	e	t	P	o	i	n	t			0	0	0	0		
A	c	t	u	a	l					0	0	0	0		
		V		2	3	0	2			0	0	0	0		
		V		2	3	0	3			0	0	0	0		

7 6 5 4 3 2 1 0 7 6 5 4 3 2 1 0

To select an individual default title, just enter “0000 0000” for its text data.

The title selections are summarized in the following table. Note the inclusion of one timer and counter, because all three preset types must have at least one entry. Finally, we select the password (disabled) and the powerup mode. We arbitrarily choose Change Preset as the Powerup Default Mode.

User Presets			Timer Presets		Counter Presets	
Text Titles	Text Locations	Data Locations	Titles	Data Locations	Counter Titles	Data Locations
Setpoint	V2200	V2300	Timer 1	V2304	Counter 1	V2305
Actual	V2204	V2301				
(V2302)	V2210	V2302				
(V2303)	V2214	V2303				

Password Enable/Disable	Password Value	Powerup Mode	Powerup Value
Disable	0000	Change Preset	0001

Using the worksheet above we can determine the setup parameters. The numbers are in bold text in the following table.

V-Memory Location	Setup Parameter Description	Format	Value	Notes:
V7620	User Preset Data Pointer	Octal	<b>2300</b>	start at V2300
V7621	User Preset Titles Pointer	Octal	<b>2200</b>	use default title
V7622	User Preset Block Size	BCD	<b>4</b>	4 titles
V7626	Powerup Mode	BCD	<b>0001</b>	Change Preset
V7627	Change Preset Password	BCD	<b>0000</b>	Disabled
V7720*	Timer Data Pointer	Octal	<b>2304</b>	start at V2304
V7721*	Counter Data Pointer	Octal	<b>2305</b>	start at V2305
V7722*	Timer Preset Block Size (high byte)	BCD	<b>0101</b>	one timer, one counter
	Counter Preset Block Size (low byte)			

\* DL130 and DL230 CPUs use different memory locations here: V7640 instead of V7720, V7641 instead of V7721, and V7642 instead of V7722.



a:\preset6.prj

## Parameter Setup: Change Preset

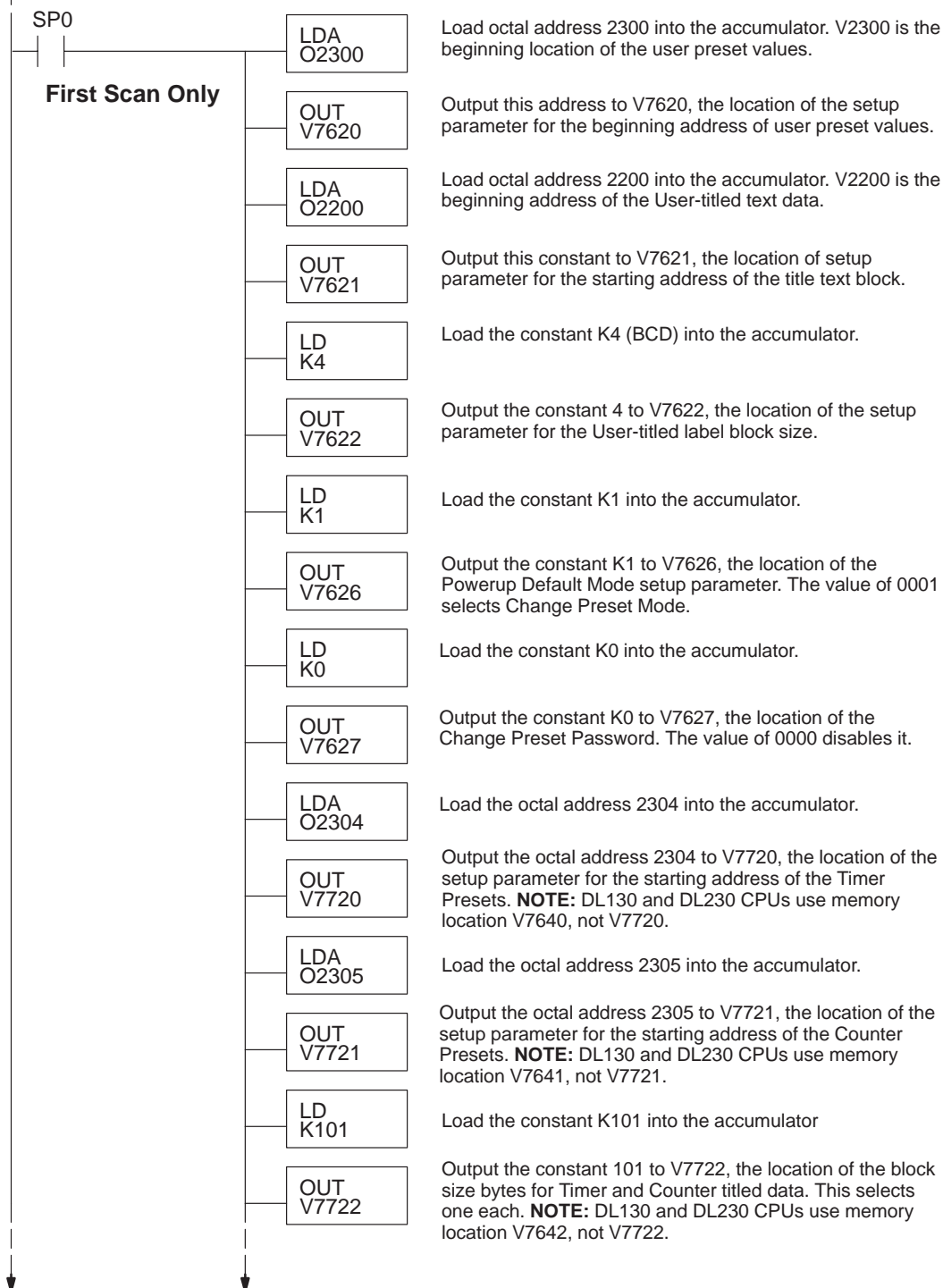

(continued)



a:\preset6.prj

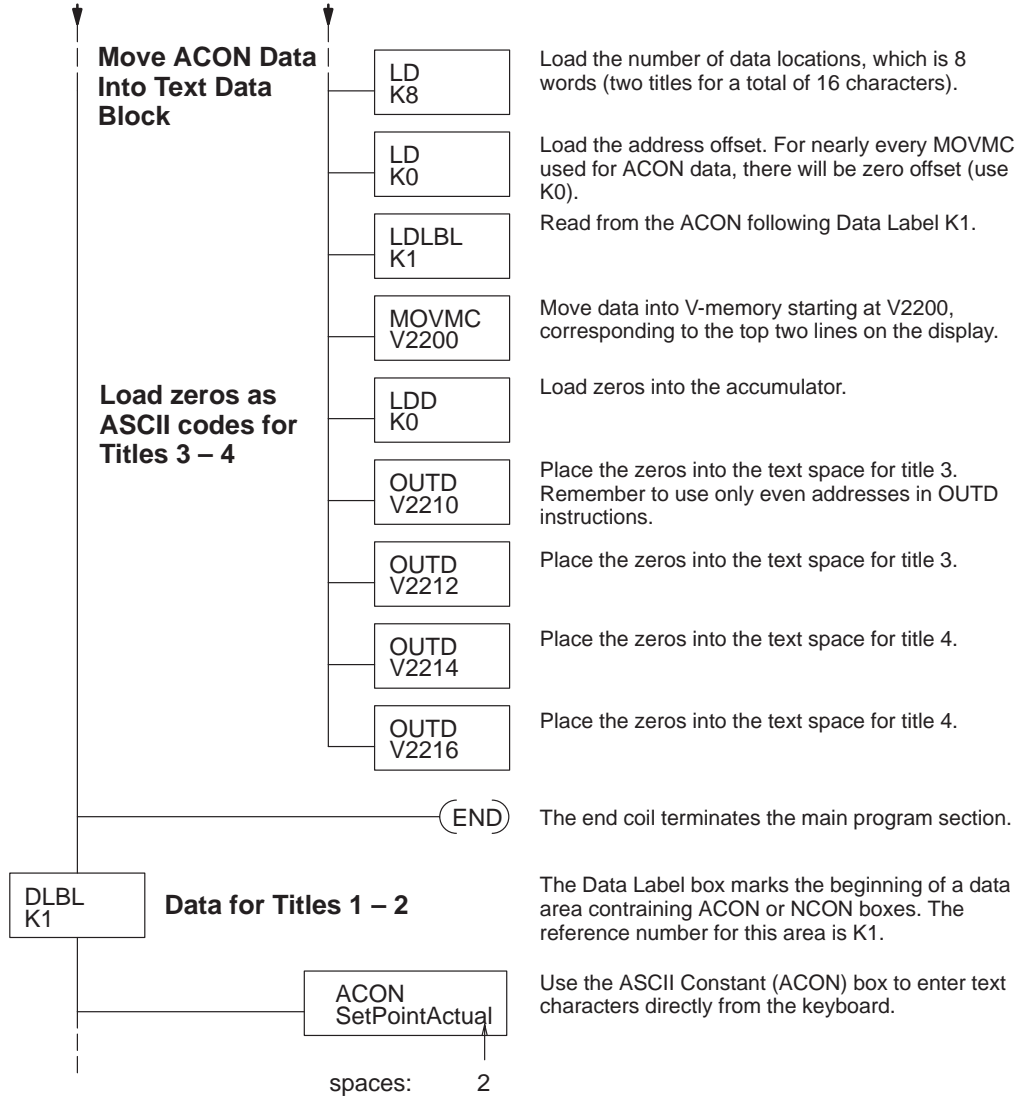

The following diagram shows the resulting displays from the program above.

S	e	t	P	o	i	n	t		0	0	0	0		
A	c	t	u	a	l				0	0	0	0		
	V	2	3	0	2				0	0	0	0		
	V	2	3	0	3				0	0	0	0		

7 6 5 4 3 2 1 0 7 6 5 4 3 2 1 0

7 6 5 4 3 2 1 0 7 6 5 4 3 2 1 0

7 6 5 4 3 2 1 0 7 6 5 4 3 2 1 0



## Combination Titles Example

As a comprehensive example, we'll use several presets of each type of title, and use a password.

- Six User-titled Presets plus two Default User-titled Presets
- Five Pre-titled Timer Presets
- Eight Pre-titled Counter Presets
- Password = 1234, Powerup Default Mode is Change Preset

**NOTE:** After loading the program for this example, a password entry is required in order to change presets. The next section covers the Change Preset Password.

The following table summarizes our choices above.

User Presets			Timer Presets		Counter Presets	
Text Titles	Text Locations	Data Locations	Titles	Data Locations	Counter Titles	Data Locations
SetPoint	V2200	V2300	Timer 1	V2310	Counter 1	V2330
Value	V2204	V2301	Timer 2	V2311	Counter 2	V2331
Hi Alarm	V2210	V2302	Timer 3	V2312	Counter 3	V2332
Lo Alarm	V2214	V2303	Timer 4	V2313	Counter 4	V2333
(V2304)	V2220	V2304	Timer 5	V2314	Counter 5	V2334
(V2305)	V2224	V2305			Counter 6	V2335
MixSpeed	V2230	V2306			Counter 7	V2336
SoakTime	V2234	V2307			Counter 8	V2337

Password Enable/Disable	Password Value	Powerup Mode	Powerup Value
Enable	1234	Change Preset	0001

Using the worksheet above we can determine the setup parameters (bold text).

V-Memory Location	Setup Parameter Description	Format	Value	Notes:
V7620	User Preset Data Pointer	Octal	<b>2300</b>	start at V2300
V7621	User Preset Titles Pointer	Octal	<b>2200</b>	start at V2200
V7622	User Preset Block Size	BCD	<b>8</b>	8 titles
V7626	Powerup Mode	BCD	<b>0002</b>	Message Mode
V7627	Change Preset Password	BCD	<b>1234</b>	code = 1234
V7720*	Titled Timer Data Pointer	Octal	<b>2300</b>	start at V2300
V7721*	Titled Counter Data Pointer	Octal	<b>2320</b>	start at V2320
V7722*	Timer Preset Block Size (high byte)	BCD	<b>0508</b>	5 timers, 8 counters
	Counter Preset Block Size (low byte)			

\* DL130 and DL230 CPUs use different memory locations here: V7640 instead of V7720, V7641 instead of V7721, and V7642 instead of V7722.

In this step we use the information in the setup parameter table and worksheet to write the program. The setup parameter portion is first, followed by the MOVMC for the ACON boxes. One portion of the program loads zeros in for the ASCII codes of the text titles, so the default Vxxxx labels appear for those titles.



a:\preset7.prj

### Parameter Setup: Change Preset

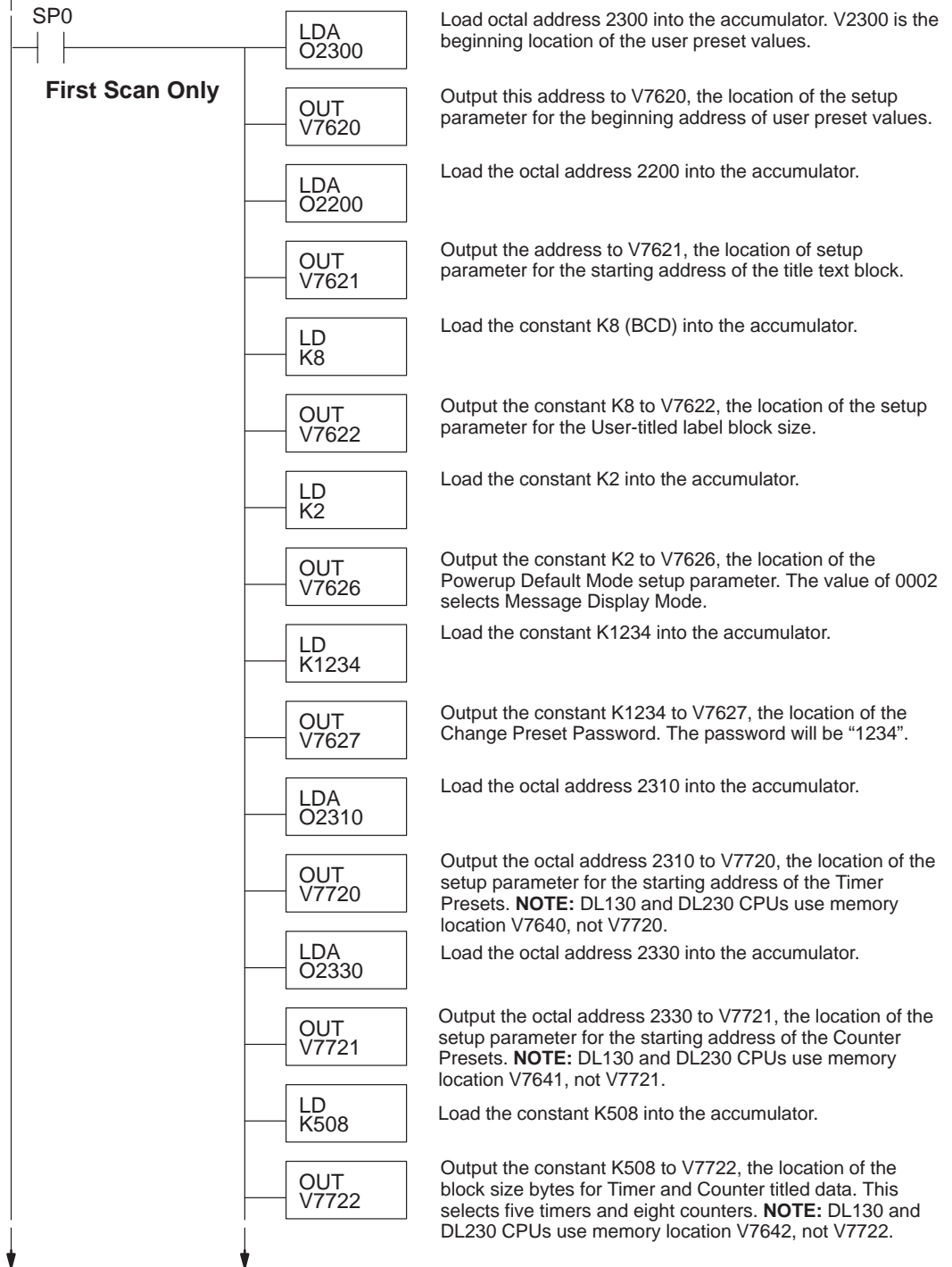

(continued)



a:\preset7.prj

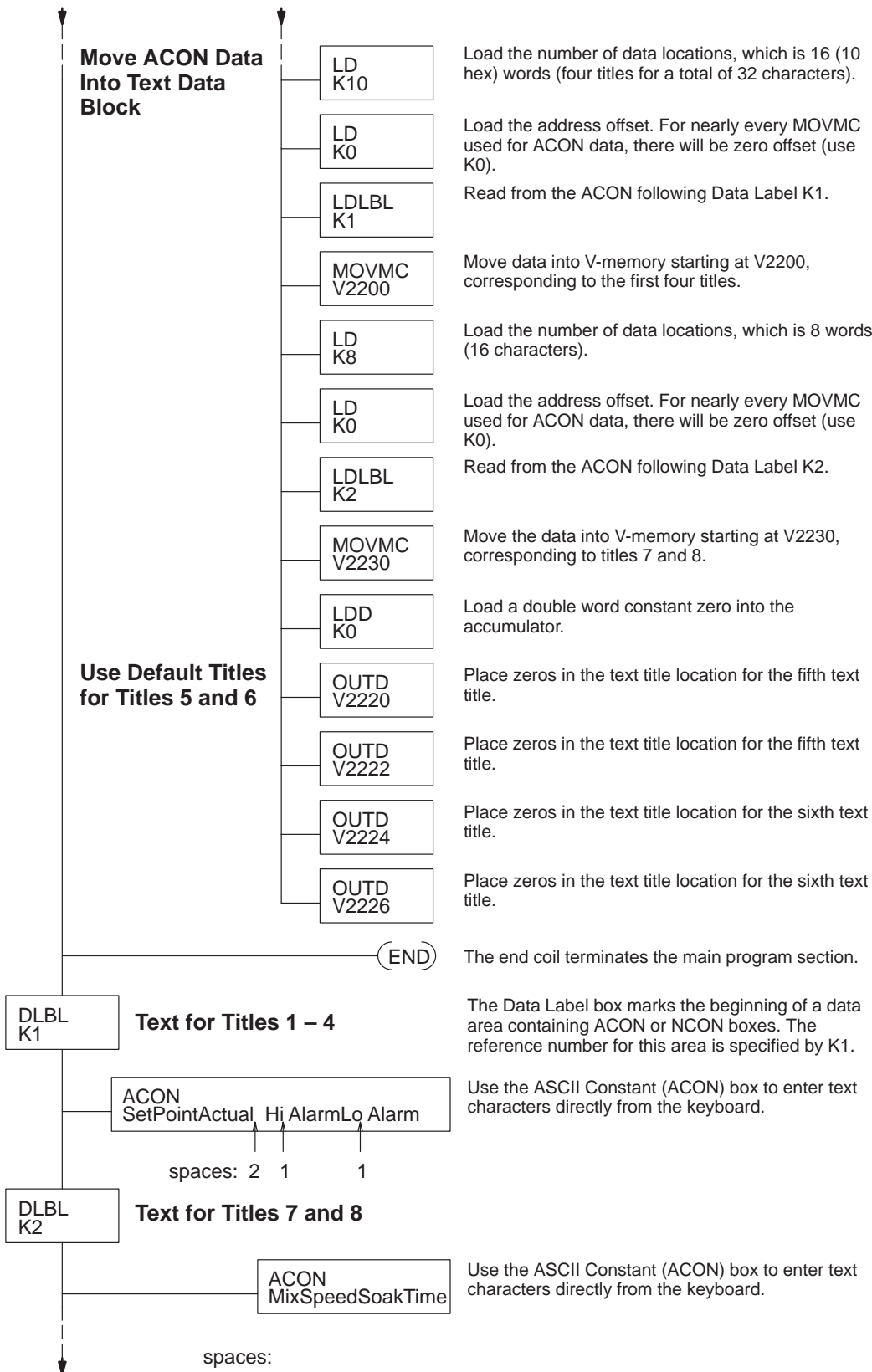

# Change Preset Password

If the setup parameters are valid you will be able to enter Change Preset Mode. And, if the password is disabled (V7627 = “0000”), you may change presets. However, if a password exists in V7627, access will be locked. When this occurs, pressing the **Enter** Key will **not** move the cursor to the data field for editing.

Feature	V7627 Contents
Password Disabled	0000
Password Enabled, password = 0001 to 9999	0001 to 9999

### Unlocking Access to Change Presets

To unlock access to change presets, go to the password utility under the Options Menu. Just press the **Options** Key, and the menu on the display below will appear. Then press the **Plus (+)** Key to cursor from item 1 to item 2 (password utility).

PRESS

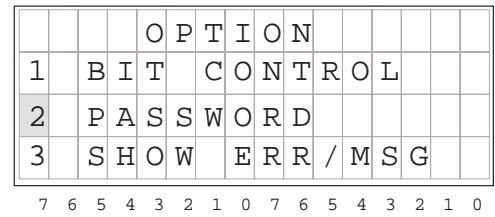

Then press the **Enter** Key, and the password display below will appear. The cursor will be over the right-most digit of the password.

PRESS

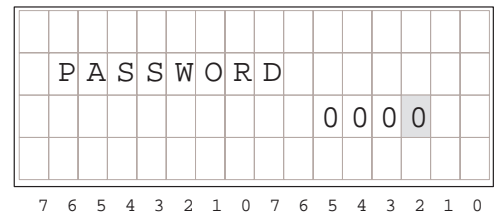

Suppose the password is “1234” (V7627 = “1234”). Now, use the **Plus (+)** Key to increment the digits, and the arrow keys to move the cursor from digit to digit. After incrementing to “1234”, press the **Enter** Key to submit the password.

PRESS

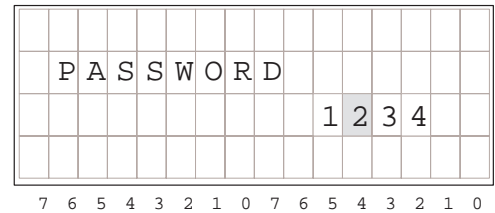

If the password submitted matches the one stored in V-memory (V7627), the display on the left will appear. If the password entry was incorrect, the display on the right will appear.

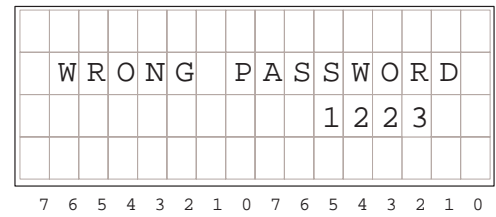
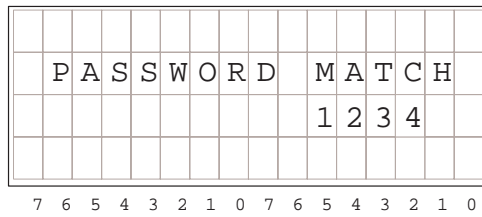

When you submit the correct password, the DV-1000 automatically returns to the Change Preset Mode. And, you will have access to change presets. Incorrect password entries are noted in the display, and the display continues to prompt you for the correct password. To abort a password entry attempt, just press one of the keys for the other DV-1000 modes.

**Locking Access to Change Presets**

After making the desired changes to presets, you may want to lock access again to Change Preset Mode. This is typical when the DV-1000 is accessible to multiple personnel on the factory floor. To lock access, return to the password utility again by pressing the **Options** Key, selecting “Password”, and pressing **Enter**. The following display will appear.

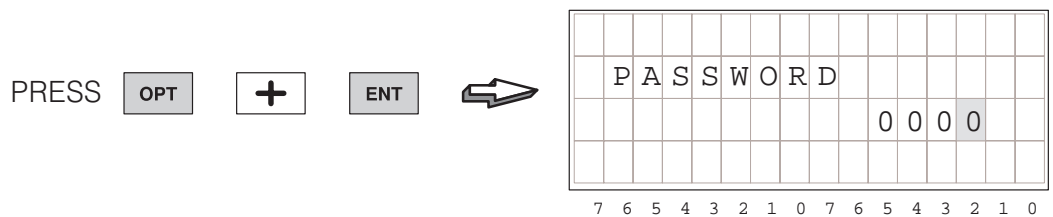

Without incrementing the password value, just press the **Enter** Key again. The display below will appear, indicating that access to change presets has been locked (note that the “0000” does not indicate that the password has been changed to that number).

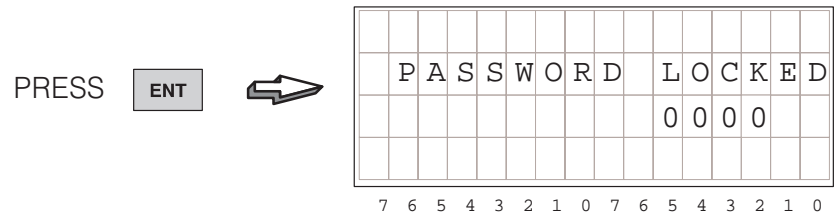

After the display indicates “PASSWORD LOCKED” for a moment, it automatically returns to Change Preset Mode. Access to changing presets will be locked, so the **Enter** Key will no longer move the cursor over to the data field. Unlocking access again only requires entering the valid password, as shown on the previous page.

**Forgot the Password?**

If the machine operator forgets the password and has no other record of it, you can use the DV-1000’s Status Display Mode to view the contents of V7627. Then go back to the Options Menu and enter the password. Note that the “Operator’s Guide to Change Preset Mode” later in this chapter intentionally does not include this tip!

# Special Topics for Change Presets

## Timer and Counter Presets with Custom Titles

If your application program requires timer and counter presets, remember that the pre-labeled Timer and Counter Preset titles in the DV-1000 are there just for your convenience. Instead of using the generic titles such as "Timer 1" you may prefer more meaningful titles for your application such as those shown to the upper right.

Counter preset titles can also be custom titles if you prefer. Some examples are listed in the display to the lower right.

S	t	o	p	T	i	m	e					0	2	1	0				
D	e	l	a	y								1	3	9	9				
R	u	n	T	i	m	e						2	8	4	7				
D	w	e	l	l								0	0	5	3				
												7	6	5	4	3	2	1	0

P	a	r	t	C	N	T						0	5	7	5				
L	e	n	g	t	h	1						1	3	3	0				
T	o	t	a	l	R	u	n					0	5	7	5				
Q	C	P	A	S	S							0	5	4	3				
												7	6	5	4	3	2	1	0

The following example creates two timers, using "StopTime" and "Delay" for timer titles. The title text is loaded with the ACON and MOVEMC instructions.



a:\preset8.prj

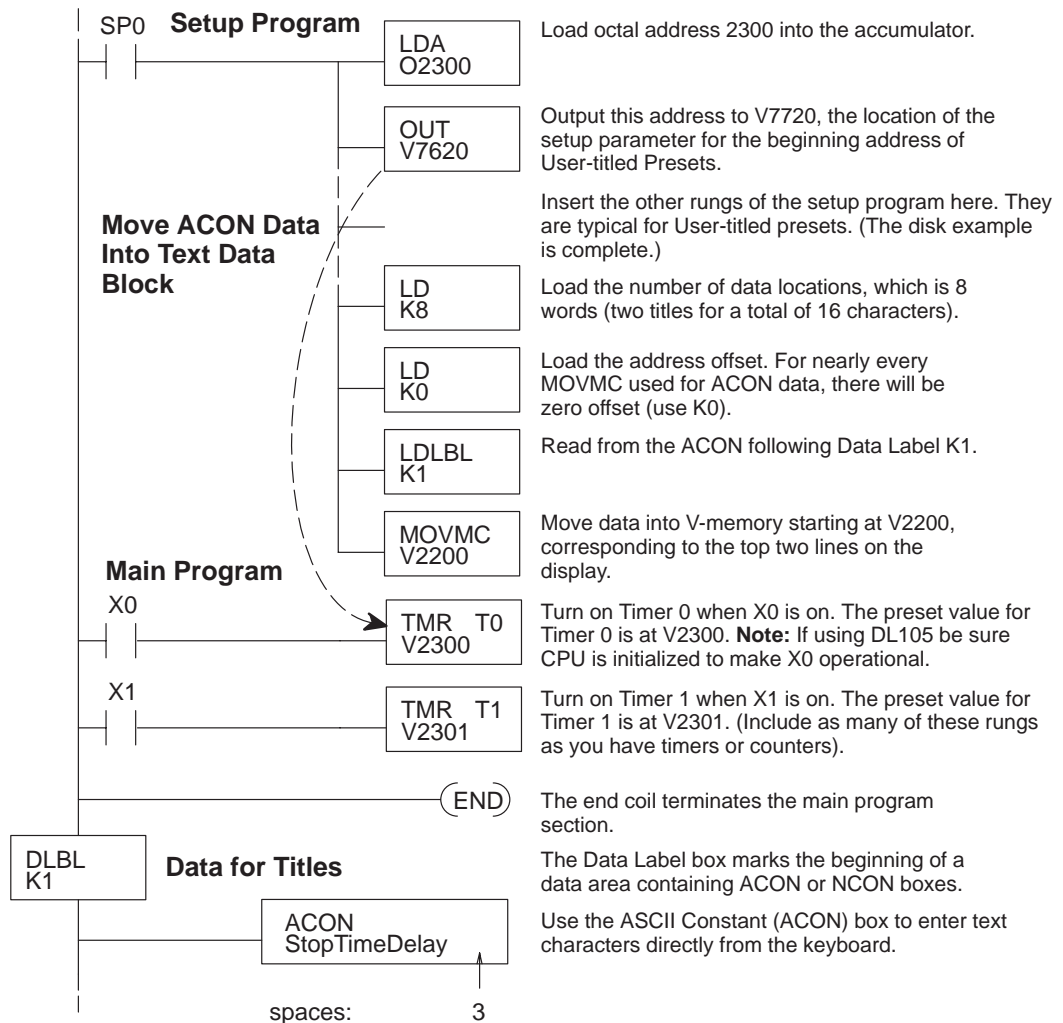

**Buffered Preset Values**

V-memory values change immediately when you edit them in Change Preset Mode. This is safely done if you make relatively small incremental changes and monitor their effects on the process. However, some applications may require you to make a single step change to one or more presets. Situations that may require this include:

- Changing a single preset to a new value, avoiding values in between
- Changing several presets to new values at the same moment (scan)
- Coordinating a preset change with other external events

We can solve these problems by using Change Preset to update a temporary variable. See the figure below. When the ladder program detects an event contact, it copies the temporary variable to the permanent variable location.

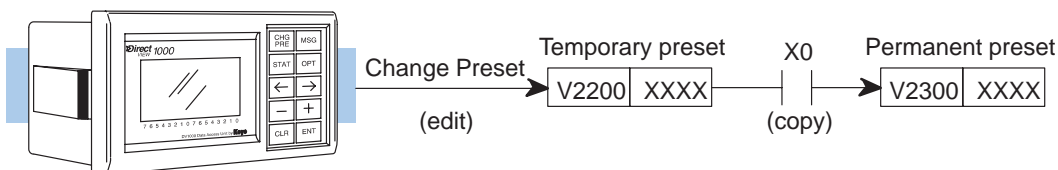

In the following program, the permanent preset value is at V2300 and the temporary preset value is at V2200. We would like to update V2300 only when input X0 has an off-to-on transition. The program also has a time-out feature. For example, enter a new value in location V2200. V2200 and V2300 no longer match so the timer starts. Turn on X0 within 30 seconds to update V2300 to match the new V2200 value. If X0 is not turned on within 30 seconds of entering the new value the program automatically changes V2200 back to match the original V2300 value. Note that changing Timer 1's preset value changes the amount of time allowed to turn on X0.

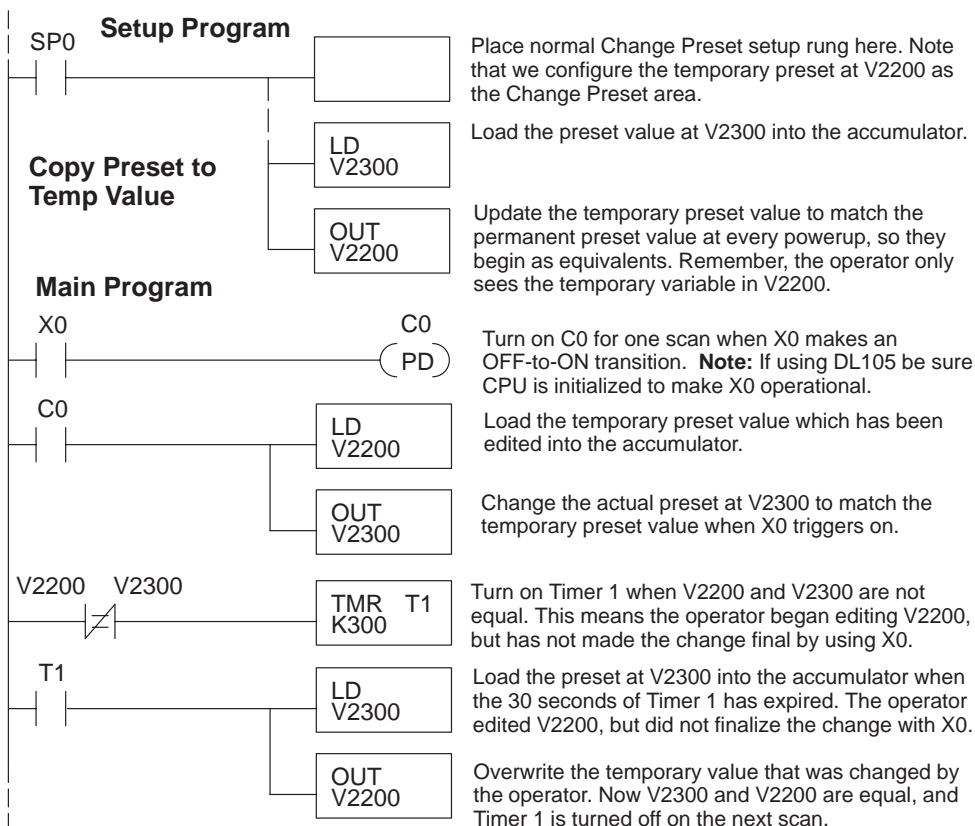

## Operator's Guide to Change Preset Mode

This 2-page guide contains condensed instructions for machine operators on how to use Change Preset Mode. It assumes the DV-1000 installation and programming are complete.

To enter Change Preset Mode, just press the **Change Preset Key** on the keypad. The User-titled Presets will appear.

PRESS **CHG PRE**



S	e	t	P	o	i	n	t							0	4	2	5		
A	c	t	u	a	l									0	4	3	2		
H	i		A	l	a	r	m							0	4	5	0		
L	o		A	l	a	r	m							0	3	9	5		

7 6 5 4 3 2 1 0 7 6 5 4 3 2 1 0 05

### Selecting the List to Display

Three change preset lists are accessible in a circular list. Refer to the figure below. Upon entry to Change Preset Mode, the first display is automatically the User-titled list. From there, use the **Right Arrow** and **Left Arrow** Keys to move to the timer titles and counter titles displays.

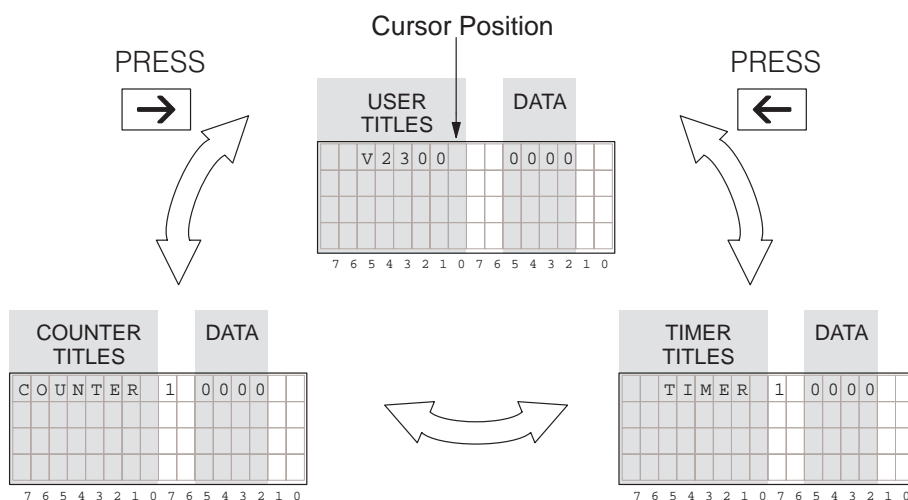

### Cursor Positioning On Title or Data

Press the **Enter** Key to toggle the cursor between the title and data fields. When the cursor is in the data field you are ready to edit the data.

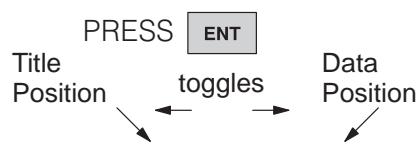

**NOTE:** If pressing the **Enter** Key does not move the cursor to the data position, access to change presets is locked. You must first enter the correct password (see next page).

S	e	t	P	o	i	n	t							0	0	0	0		
A	c	t	u	a	l									0	0	0	0		
	v		2	3	0	2								0	0	0	0		
	v		2	3	0	3								0	0	0	0		

7 6 5 4 3 2 1 0 7 6 5 4 3 2 1 0

**WARNING:** Changing the preset value on the display immediately changes the value in PLC V-memory (the display is not buffered). Equipment damage or personnel injury may occur from improper use of this mode. Be sure to pause a moment after each keystroke to allow for the DV-1000 display update, so that you are viewing current values of Change Preset variables.



### Scrolling Through Change Preset Lists

To scroll the display window downward or upward through a selected list, position the cursor over the title (use the **Enter Key** to toggle its position between the title or data. Then use the **Plus (+)** and **Minus (-)** Keys to scroll the display.

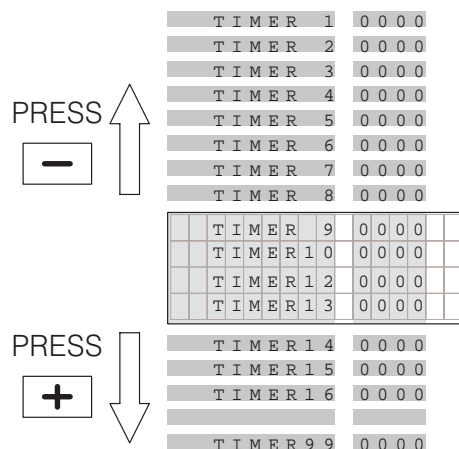
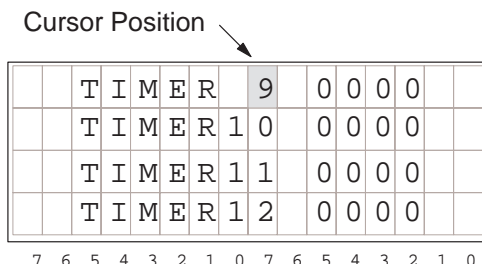

### Changing the Preset Value

With the cursor in the data position, use the **Cursor Right** and **Cursor Left** keys to move it among the four digit positions.

Press the **Plus (+)** Key to increment a digit, and the **Minus (-)** Key to decrement it. The range of input change is from 0000 to 9999, BCD. Incrementing past 9 or decrementing past 0 carries to or borrows from (respectively) the digit(s) to the left of the cursor position.

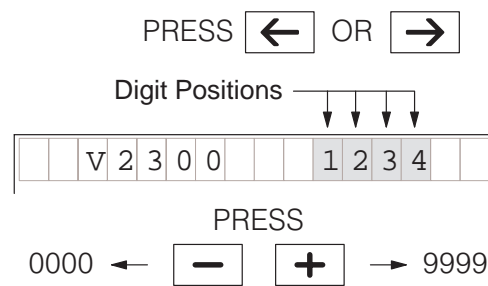

### Entering a Password

To enter a password, press the **Options Key** to view the Options menu. Press the **Plus (+)** Key to move the cursor to the password option. Then press the **Enter Key**. Use the **Plus (+)** Key and **Cursor Keys** to increment the password code to the correct value. Then press **Enter**.

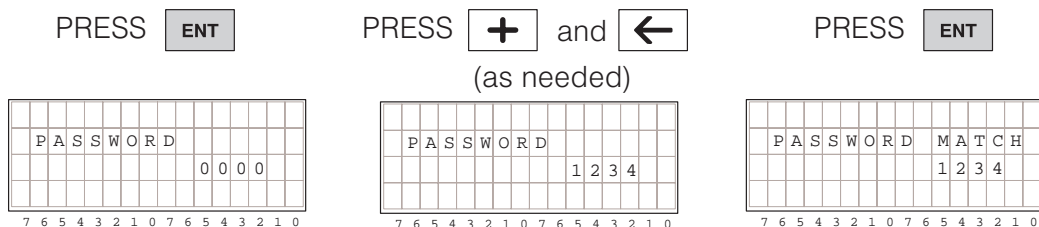
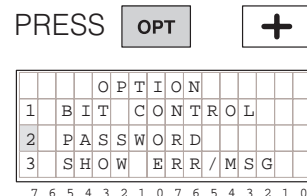

For correct password entries, the message “PASSWORD MATCH” is briefly displayed. The DV-1000 returns to the previous (Change Preset) Mode. Incorrect passwords yield the message “WRONG PASSWORD”.

### Locking Access to Change Presets

If your DV-1000 setup requires a password, you can lock access again after changing presets. Just follow the instructions above for entering a password, but enter “0000” for the password. The message “PASSWORD LOCKED” confirms your action. Now access to changing presets is locked.

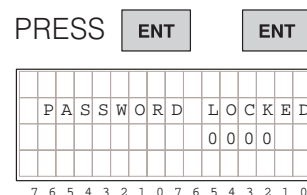

## Chapter Summary

### Summary of Key Points

Now we have covered Change Preset title types and how to edit data using the keypad.

We may summarize some of the key points we have learned about Change Preset Mode in this chapter:

- *Change Preset* simply means *Change V-memory data*.
- Changing data on the display **immediately** changes the value in the PLC. There is no prompt for confirmation of the change.
- In order for the change of a preset (V-memory data) to change the behavior of your process, some instruction(s) in the ladder main program has to *read* the V-memory data and use it.
- Three types of preset titles are available in Change Preset Mode.
- If you use Change Preset Mode in your application, all three title types must be set up for at least one title. This means the three block size setup parameters must be equal to one or greater.
- Access to changing presets can be password protected with password codes 0001 – 9999. If you do not wish to use a password, program the code “0000” into the password location to disable the password feature.
- If you are using a Timer or Counter Box Instruction and you want to change its preset value with Preset Mode, it **must** be a Vxxxx variable type, not a constant Kx!
- If preferred, you can have User-titled preset labels for timers and counters in the ladder program. The pre-labeled timer and counter titles are just for your convenience, and to conserve V-memory when required.
- Change Preset Mode will allow the editing of BCD numbers (0000 to 9999). If a V-memory location contains a hex number, Change Preset will not allow the editing of its value!
- The setup program for change Preset Mode can generally be confined to execute on the first scan, as do all the program examples in this chapter.
- The Operator’s Guide near the end of this chapter contains instructions for a machine operator on how to change presets. Feel free to copy its two pages and post it on the machine as a resource for its operator(s).
- Appendix C contains worksheets for Change Preset Mode for you to copy and use to create your application program.