

OPT2041

Fiber Optic Cable Sensor



Operating Instructions

Index

1. Proper Use	3
2. Safety Precautions	3
3. General Information Regarding the Device	3
4. Device Features	4
4.1. Connection Diagrams	4
4.2. Housing Dimensions	4
4.3. Declaration of Conformity	4
4.4. Technical Data	5
4.5. Complementary Products	6
4.6. Control Panel	6
4.7. Installation Instructions	6
4.7.1. Mounting to a DIN rail	6
4.7.2. Side mounting	7
4.7.3. Connecting the plastic fibre-optic cable	7
5. Initial Operation	8
5.1. Overview of Functions	8
5.2. Menu Structure	9
6. Adjustment	10
6.1. Run	10
6.2. Teach-In	10
6.3. Output	12
6.3.1. ON-/OFF-Delay	13
6.4. Operating Mode	13
6.5. Filter	13
6.6. Display	14
6.7. Language	14
6.8. Information	15
6.9. Reset	15
6.10. Password	15
7. IO-Link Parameter and Process data	16
8. Maintenance Instructions	19
9. Proper Disposal	19

1. Proper Use

This wenglor product is used in accordance with the following mode of operation:

Both plastic fiber optic cables and glass fiber optic cables can be connected to fiber optic cable sensors. Universal reflex sensors can be used both with and without fiber optic cables. Fiber optic cable sensors analyze the light reflected by the object. The output switches when an object reaches the selected range (detection) or when the active light beam is interrupted (operating limits). Bright objects reflect more light than dark objects, and can thus be recognized from greater distances. In barrier operation, the color of the object has no effect on the range.

2. Safety Precautions

- This operating instruction is part of the product and must be kept during its entire service life.
- Read this operating instruction carefully before using the product.
- Installation, start-up and maintenance of this product has only to be carried out by trained personal.
- Tampering with or modifying the product is not permissible.
- Protect the product against contamination during start-up.
- Not a safety component in accordance with the EU Machinery Directive

3. General Information Regarding the Device

wenglor fiber optic cables can be adapted to these Sensors. The modern OLED display assures easy, menu-driven Sensor setup. Signal strengths and the switching threshold can be read from the display as numeric values or as a bar graph. Convenient programming and quick diagnosis is possible via the IO-Link interface.

4. Device Features

4.1. Connection Diagrams

774

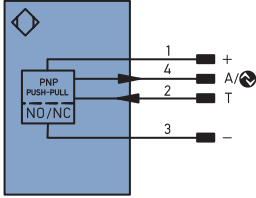

- + Supply Voltage "+"
- A/IO-Link Switching Output/IO-Link
- T Teach Input
- Supply Voltage "0 V"

4.2. Housing Dimensions

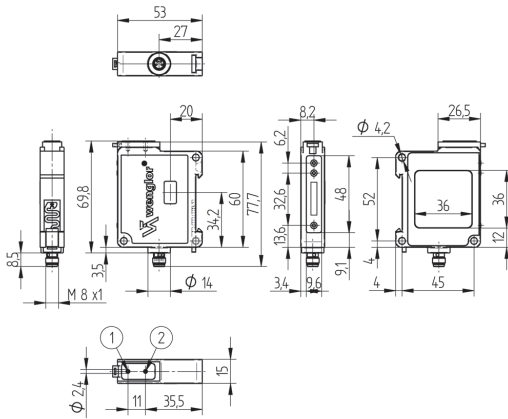

- 1 = Transmitter Diode
- 2 = Receiver Diode

4.3. Declaration of Conformity

The EC declaration of conformity can be found on our website at www.wenglor.com in download area.



4.4. Technical Data

Optical Data	
Switching Hysteresis	< 15 %
Light Source	Red Light
Wave Length	660 nm
Service Life (T = +25 °C)	100000 h
Max. Ambient Light	10000 Lux
Electrical Data	
Supply Voltage 18...30 V DC	18...30 V DC
Current Consumption (U _b = 24 V)	< 40 mA
Switching Frequency	4 kHz
Response Time	125 μs
On-/Off-Delay	0...10000 ms
Temperature Drift	< 10 %
Temperature Range	-25...60 °C
Switching Output Voltage Drop	< 2,5 V
Switching Output / Switching Current	100 mA
Short Circuit Protection	yes
Reverse Polarity Protection	yes
Overload Protection	yes
Teach Mode	NT, MT, ZT, DT, FT, HT, TP
Interface	IO-Link
IO-Link Version	1.0
IO-Link Parameter	> 12
Protection Class	III
Mechanical Data	
Adjustment	Teach-In
Housing Material	Plastic
Degree of Protection	IP65
Connection	M8×1; 4-pin
DIN-Rail mounting	35 mm
General Data	
Selectable menu language	X
Password Protection	X
Output	
Configurable as PNP/Push-Pull	yes
NO/NC switchable	yes
IO-Link	yes

4.5. Complementary Products

Glass Fiber Optic Cable

Plastic Fiber Optic Cable

4.6. Control Panel

X 4



20 = Enter Button
22 = Up Button
23 = Down Button
60 = Display

4.7. Installation Instructions

All applicable electrical and mechanical regulations, standards and safety precautions must be adhered to when installing and operating the Sensor. The Sensor must be protected against mechanical influences. Install the device such that its installation position cannot be inadvertently changed.

4.7.1. Mounting to a DIN rail



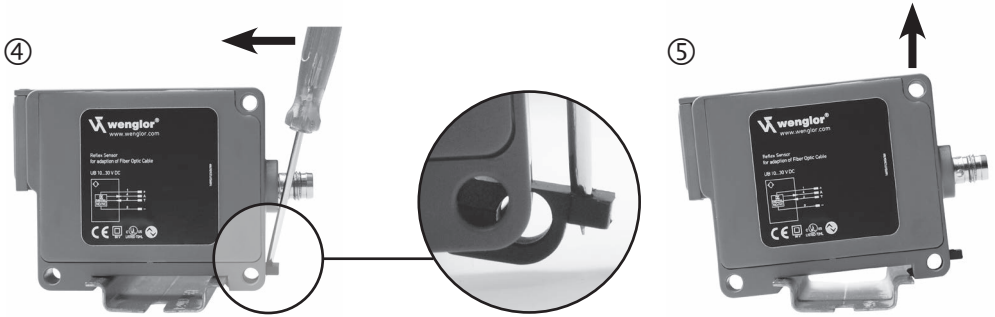

fig.1 Mounting of the Sensor to a DIN rail

4.7.2. Side mounting

Side mounting a unit: Secure the Sensor with screws (M4) through the mounting holes.



fig. 2 Side mounting of the Sensor

4.7.3. Connecting the plastic fibre-optic cable

- Please cut the plastic fibre-optic cable once before using with the cutting tool.
- Open the mounting slide with a screwdriver (see fig. 3-1)
- Insert the light cable into the opening provided to this end (see fig.. 3-2)
- Close the mounting slide (see fig. 3-3)



fig. 3 Connecting the plastic fibre-optic cable

5. Initial Operation

Connect the Sensor to 18 to 30 V DC before configuring the settings.

The desired menu language must be selected after initial operation, and after each reset. See section 6.7 in this regard.

Switch to the configuration menu by pressing any key.

Note: If no settings are adjusted in the configuration menu for a period of 30 seconds, the Sensor is automatically returned to the display mode.

The Sensor accesses the last used menu view when a key is once again activated. If a setting is configured, it becomes active when the configuration menu is exited.

The keys are used for navigation, and for configuring settings. The functions of the navigation keys vary from menu to menu. The functions of the keys appear in the display as follows:

- ▲ : Navigate up.
- ▼ : Navigate down.
- ◀ Back: Move up one level within the menu.
- ◀◀ Run: Switch to the display mode.

Selection is acknowledged with the enter key.

Important: Do not use any sharp objects to press the keys when configuring settings, because they might otherwise be damaged.

5.1. Overview of Functions

Description	Function	Page
Run	Switch to display mode	10
Teach	Teach-In the Sensor	10
Output	Select output function	12
Operating Mode	Select the Sensitivity	13
Filter	Filter settings	13
Display	Select display characteristics	14
Language	Select the desired menu language	14
Info	Read out information regarding the Sensor	15
Reset	Return to default settings	15
Password	Protection against unauthorized changes to settings	15

5.2. Menu Structure

The Sensor's menu is laid out as follows:

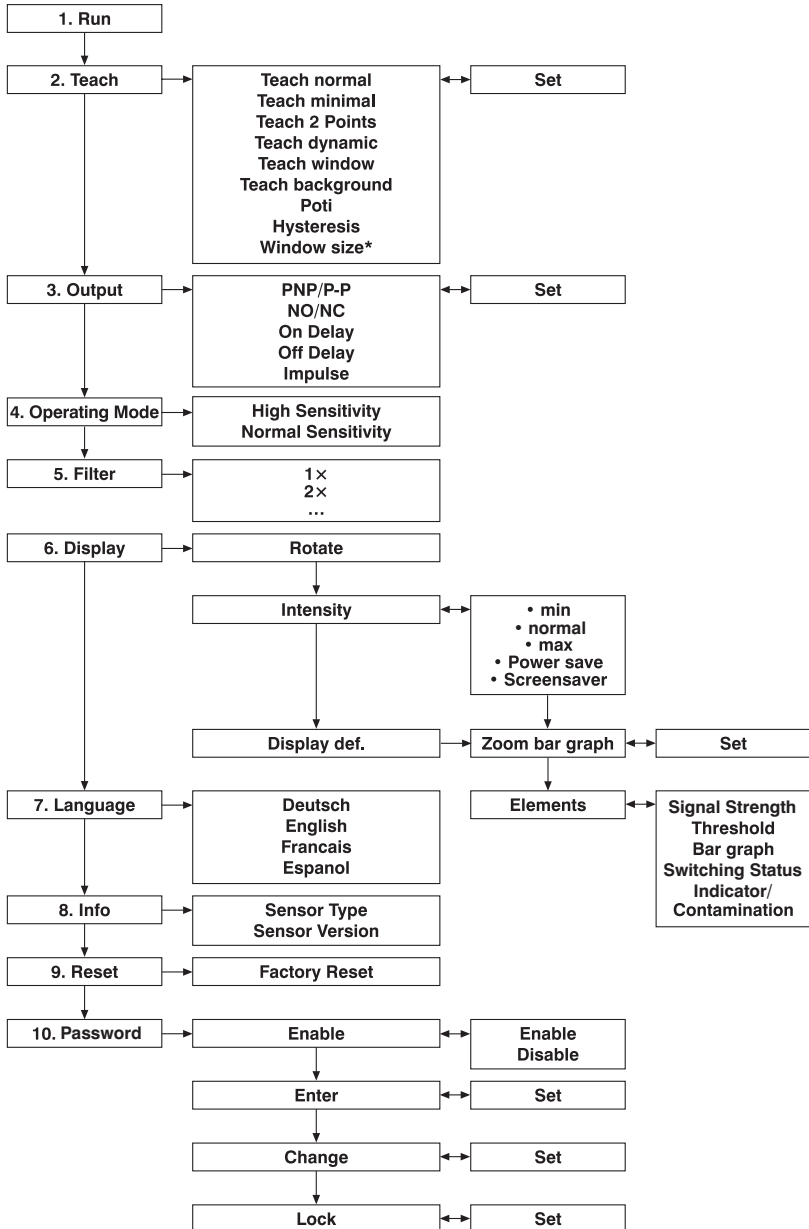

* Only after Window Teach

6. Adjustment

6.1. Run



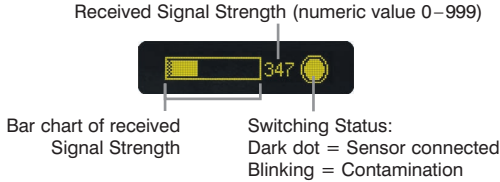





The Sensor is switched to the display mode when the enter key is pressed.

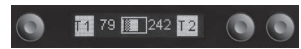
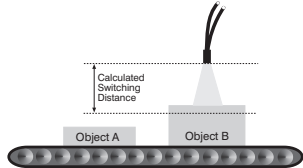

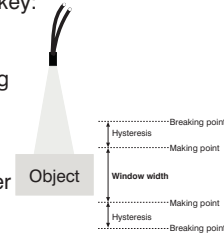
6.2. Teach-In

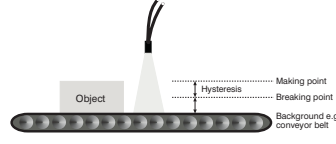
The Sensor is set up with the help of the teach-in menu.

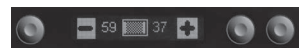
Function	Description
	<p>Normal Teach-In</p> <p>The object is taught in by pressing the T key:</p> <ul style="list-style-type: none"> Align the spot to the object. Briefly press the T key. → The switching distance to the object is set. If necessary, readjust the switching distance with the help of the “Potentiometer” menu item.
	<p>Minimal Teach-In/Glass recognition</p> <p>The object is taught in by pressing the T key:</p> <ul style="list-style-type: none"> Align the spot to the object. Briefly press the T key. → The switching distance to the object is set. If necessary, readjust the switching distance with the help of the “Potentiometer” menu item.
	<p>Dynamic Teach-In</p> <p>The Sensor enters a recording phase when the T1 key is pressed, and the minimum and maximum signal strength are saved to memory.</p> <ul style="list-style-type: none"> Align the spot to the background (e. g. conveyor belt). Briefly press the T1 key. Move objects through the light beam. Briefly press the T2 key. → The switching point is set automatically between the minimum and maximum signal strength saved to memory during the recording phase.

T 2-Point	Two-Point Teach-In
	<p>Two objects are taught in by pressing the T1 and T2 keys.</p> <ul style="list-style-type: none"> • Align the spot to object A. • Briefly press the T1 key. • Align the spot to object B. • Briefly press the T2 key. <p>→ The switching point is automatically set between the signal strength from objects A and B.</p> 
T Window	Window Teach-In
	<p>A window tolerance is taught in by pressing the T key:</p> <ul style="list-style-type: none"> • Align the spot to the object. • Briefly press the T key. <p>→ tolerance window is set up around the switching point. The window width value and hysteresis are both adjustable (see below).</p> <p>If the object is located within the window width, the Sensor is switched. The lower and the upper switching thresholds are displayed alternately while the window is being taught in.</p> 
T Background	Background Teach-In
	<p>The background is taught in by pressing the T key, so that it can be virtual suppressed:</p> <ul style="list-style-type: none"> • Align the spot to the background (e. g. conveyor belt). • Briefly press the T key. <p>→ The Switching Point is set slightly in front of the background.</p> 
Potentiometer	Readjusting Switching Distance
	<p>Switching distance can be readjusted by pressing the + or – key.*</p>
Hysteresis	Adjusting Switching Hysteresis
	<p>The hysteresis value is adjusted by pressing the + or – key.* Normal Sensitivity: Minimum value: 20, maximum value: 200 High Sensitivity: Minimum value: 45, maximum value: 200</p>
Window Width	Setting Window Width
	<p>(only adjustable after window teach-in) Window width is selected by pressing the + or – key. *Minimum value: 25, maximum value: 500</p>

* Press and hold the + or – key in order to scroll quickly through the numbers.

External Teach-In

The last teach-in procedure selected from the menu is used during external teach-in.

For this reason, the desired teach-in procedure must be executed once before external teach-in.



- Set the Sensor to the display mode.
 - The utilized teach-in procedure appears at the display.
- Apply 10 to 30 V DC to the teach-in input for at least one second.
 - The teach-in procedure is executed.

Notes regarding external teach-in:

- The two-point teach-in mode cannot be executed externally.
- In the dynamic teach-in mode, the recording phase continues for as long as voltage is applied to the teach-in input.

6.3. Output

The device's output is set up with the help of the output menu.

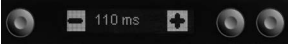
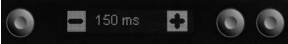
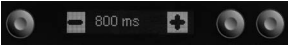
Function	Description
PNP/Push-Pull	Selecting the Output Type
	The PNP or push-pull output type can be selected by pressing the navigation keys, and the selection is acknowledged by pressing the enter key.
NO/NC	Selecting the Output Function
	The normally open or normally closed output function is selected by pressing the NO or the NC key. The respective circuit diagram is displayed.
On-Delay	Adjusting On-Delay
	On-delay can be adjusted within a range of 0 to 1000 ms by pressing the + or – key.* See figure 4 on page 29.
Off-Delay	Adjusting Off-Delay
	Off-delay can be adjusted within a range of 0 to 10000 ms by pressing the + or – key.* Off-delay is disabled if a impulse duration has already been selected. See figure 4 on page 29.
Impulse	Adjusting Impulse Duration
	<p>Pulse duration defines how long the output signal remains in the activated state. A impulse length can be selected within a range of 0 to 10000 ms by pressing the + or – key.* After the selected pulse duration has elapsed, the output signal is returned to the deactivated state.</p> <p>(Description applies to NO contacts in scanning mode or NC contacts in barrier mode.)</p>

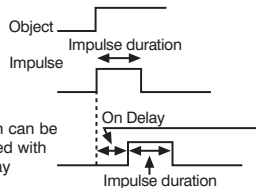

* Press and hold the + or – key in order to scroll quickly through the numbers.

6.3.1. ON-/OFF-Delay

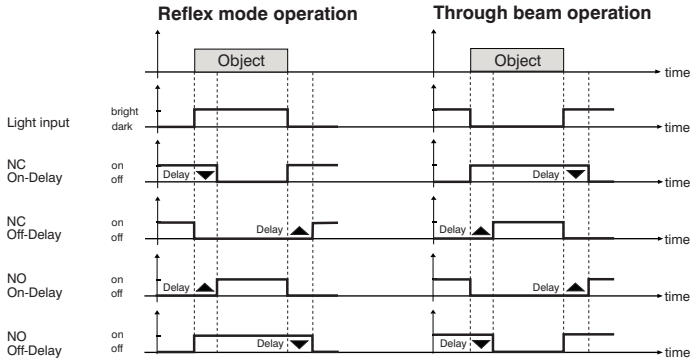
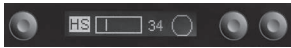

fig. 4 ON-/OFF-Delay

6.4. Operating Mode

In the menu operating mode, the sensitivity of the Sensor is set.

Function	Description
Operating Mode	Operating Mode with high Sensitivity
	<p>By pressing the key ▲ and ▼ the desired operating mode is selected and confirmed by pressing the Enter key.</p> <p>High Sensitivity: Highest sensitivity for large ranges.</p> <p>Normal Sensitivity: Normal sensitivity for standard applications.</p>

6.5. Filter

The filter function is set in the menu Filter.



Function	Description
Filter	Set Filter
	<p>By pressing the key + or – a filter is set respectively the filter function is deactivated.</p> <p>If the filter function is set, several additional light impulses are used in order to make the signal more resistant against influences of ambient light.</p> <p>Note: An augmentation of the filter reduces the max. Switching Frequency proportionally.</p>

Filter	1	2*	3	4	5	6	7	8
Switching Frequency	4 kHz	2 kHz	1,3 kHz	1 kHz	800 Hz	660 Hz	570 Hz	500 Hz

* Default Setting

6.6. Display

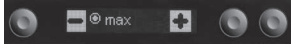
The display is set up with the help of the display menu.

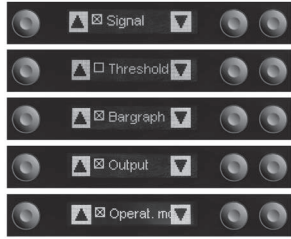
Function	Description
	Rotating the Display The display is rotated 180° by pressing the enter key. The display can be returned to its original position by pressing the same key once again.
	Adjusting Display Brightness After pressing the ▶ and ◀ keys, the menu appears immediately with the selected brightness setting (min., normal or max). In setting power save the display turns off after 60 seconds. In setting screensaver, the display inverts every 60 seconds. The brightness is set to normal during these settings. Selection is acknowledged by pressing the enter key.
	Defining the Display Zooming the bar graph: The bar graph is zoomed by pressing the ▲ and ▼ keys. Display elements: The elements which will appear at the display can be selected with the ▲ and ▼ keys and acknowledged by pressing the enter key. <u>Displayable elements include:</u> <ul style="list-style-type: none"> • Signal Strength (numeric value 0 – 999) • Threshold (numeric value 0 – 999) • Bar graph • Switching Status Indicator/contamination warning (output) • Operating Mode The elements can be displayed all together, individually or in any desired combination.
	

6.7. Language

The desired menu language can be selected in the “Language” menu.

Function	Description
	Selecting the Display Language The desired display language is selected by pressing the ▲ and ▼ keys, and is acknowledged by pressing the enter key. The desired language appears in the menus as soon as it has been selected. <u>Selectable languages:</u> <ul style="list-style-type: none"> • German • English • French • Spanish The display language must be selected after initial start-up, and after each reset.

6.8. Information

The following information regarding the Sensor is displayed in the “Info” menu:

- Sensor type
- Sensor version





6.9. Reset

Sensor settings can be returned to their default values with the help of the “Reset” menu.

Function	Description
Reset	Default Settings
	All of the selected Sensor settings are returned to their default values by pressing the R key.

6.10. Password

The Sensor can be locked by entering a password in the “Password” menu, so that setting can not be readjusted.

Function	Description
Enable	Switching the Password Function On or Off
	“Enable” or “Disable” can be selected with the ▲ and ▼ keys. The password function is thus switched on or off. If the password function is activated, Sensor operation is disabled after supply power has been interrupted. Immediate disabling is also possible with the help of the “Disable” submenu.
Enter	Password Entry for Enabling the Sensor
	The password for enabling the Sensor is selected with the + or – key.* Selection is acknowledged by pressing the enter key. The password is set to “0” upon shipment from the factory.
Change	Changing the Password
	The desired new password is selected with the + or – key.* Selection is acknowledged and the password is changed by pressing the enter key.
Disabling	Disabling the Sensor
	The Sensor is disabled without interrupting supply power. The Sensor is disabled by pressing the enter key, and the password entry window is displayed immediately. The Sensor is switched to the display mode after approximately 30 seconds. A password must be entered in order to continue using the Sensor.

Notes regarding password functions:

If the password function has been activated, the password must be entered each time supply power to the Sensor is interrupted. After pressing a key, the menu is automatically switched to the password entry mode. After the password has been correctly entered, the entire menu is enabled and the Sensor can be operated.

- The password function is deactivated upon shipment from the factory.
- The password is set to “0” upon shipment from the factory.
- Passwords can be selected within a range of 0000 to 9999.

It must be assured that the newly selected password is noted before the password is changed. If the password is forgotten, it must be overwritten with a master password. The master password can be requested by e-mail from techbox@automationdirect.com.

7. IO-Link Parameter and Process data

Addressing via IO-Link

The Index is set to „1“ at all times. Thereby the Direct Parameter Page can be reached, where then the several Parameters can be set by the Subindexes.

Subindex „0“	→ read all Parameters	
Subindex „1“	→ Parameter 0	read/write
Subindex „2“	→ Parameter 1	read/write
...

Process bytes

Process byte 0

Bit 0	Output status	1 = switched
Bit 1	Contamination	1 = contaminated
Bit 2		
Bit 3		
Bit 4		
Bit 5		
Bit 6		
Bit 7		

Process byte 1

Bit 0	Signal Strength Bit 0
Bit 1	Signal Strength Bit 1
Bit 2	Signal Strength Bit 2
Bit 3	Signal Strength Bit 3
Bit 4	Signal Strength Bit 4
Bit 5	Signal Strength Bit 5
Bit 6	Signal Strength Bit 6
Bit 7	Signal Strength Bit 7

Parameter

Main Page (Parameter 0 Bit 7-0)

Parameter 0

Bit 0	Reset to delivery status	1 = Do reset
Bit 1	Display Language	00 = German, 01 = English,
Bit 2	Display Language	10 = French, 11 = Spanish

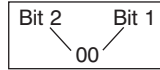

Bit 3	Rotate Display 180°	1 = rotate
Bit 4	Display Brightness	00 = min, 01 = normal,
Bit 5	Display Brightness	10 = max

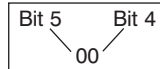

Bit 6	Lock Sensor	1 = Sensor is locked
Bit 7	Switch to	1 = Configuration Page

At Switch to =1:

Bit 0–6	Selection of Configuration Page	
Bit 7	Switch to	1 = Configuration Page

Is Bit 7 in Parameter 0 set to „1“, more Configuration Pages can be reached. For this purpose the corresponding address of the Configuration Page (in brackets) is set to parameter 0 Bit 0–6.

Parameter 1

Bit 0	NC/NO	1 = NC
Bit 1	Start Teach-In	1 = Start teaching
Bit 2	PNP/NPN/Push-Pull	0 = PNP, 1 = Push-Pull
Bit 3		
Bit 4	Teach step	1 = 2 nd Teach Point/ End of Dynamic Teach
Bit 5	Teach mode	000 = Normal, 001 = Minimal,
Bit 6	Teach mode	010 = Dynamic
Bit 7	Teach mode	011 = 2-Point
		100 = Window
		101 = Background

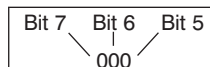

Parameter 2 High Byte On Delay in ms

Parameter 3 Low Byte On Delay in ms

Parameter 4	High Byte Off Delay in ms
Parameter 5	Low Byte Off Delay in ms
Parameter 6	High Byte Impulse Duration in ms
Parameter 7	Low Byte Impulse Duration in ms
Parameter 8	High Byte of lower Threshold
Parameter 9	Low Byte of lower Threshold
Parameter 10	High Byte of upper Threshold
Parameter 11	Low Byte of upper Threshold

Configuration Page (0x80)

Parameter 1	Serial number Byte 1
Parameter 2	Serial number Byte 2
Parameter 3	Serial number Byte 3
Parameter 4	Serial number Byte 4
Parameter 5	DeviceID Byte 1
Parameter 6	DeviceID Byte 2
Parameter 7	DeviceID Byte 3
Parameter 8	Revision
Parameter 9	
Parameter 10	
Parameter 11	

Configuration Page (0x81)

Parameter 1	Filter Settings	0x00 = not allowed
	Filter Settings	0x01 = Filter off
	Filter Settings	0x03 = ×2
	Filter Settings	0x07 = ×3
	Filter Settings	0x0f = ×4
	Filter Settings	0x1f = ×5
	Filter Settings	0x3f = ×6
	Filter Settings	0x7f = ×7
	Filter Settings	0xff = ×8

Parameter 2

Bit 0	Operating Mode	1 = High Sensitivity 0 = Normal Sensitivity
Bit 1	Zoom Bar graph	
Bit 2	Zoom Bar graph	
Bit 3	Zoom Bar graph	
Bit 4	Zoom Bar graph	

Parameter 3

Bit 0	Display element: Threshold
Bit 1	Display element: Bar graph
Bit 2	Display element: Signal Strength
Bit 3	Display element: Switching Status Indicator
Bit 4	Display element: Operating Mode

Parameter 4 High Byte of Lower Threshold 2

Parameter 5 Low Byte of Lower Threshold 2

Parameter 6 High Byte of Upper Threshold 2

Parameter 7 Low Byte of Upper Threshold 2

Parameter 8

Parameter 9

Parameter 10

Parameter 11

8. Maintenance Instructions

- This wenglor Sensor is maintenance-free.
- It is advisable to clean the lens and the display, and to check the plug connections at regular intervals.
- Do not clean with solvents or cleansers which could damage the device.

9. Proper Disposal

wenglor sensoric gmbh does not accept the return of unusable or irreparable products. Respectively valid national waste disposal regulations apply to product disposal.