

# Applying Ladder Logic

## General Concepts

### Memory Mapping

The OP-1224 uses memory mapping in order to link itself to a PLC. Memory mapping is a technique that maps the memory of the OP-1224 into the memory of the PLC. During initial configuration, you indicate where in the PLC memory you want to start the mapping process (Refer to the OP-WINEDIT manual). By knowing where the data of the specific panel is mapped, this data can be moved, changed or monitored using ladder logic.

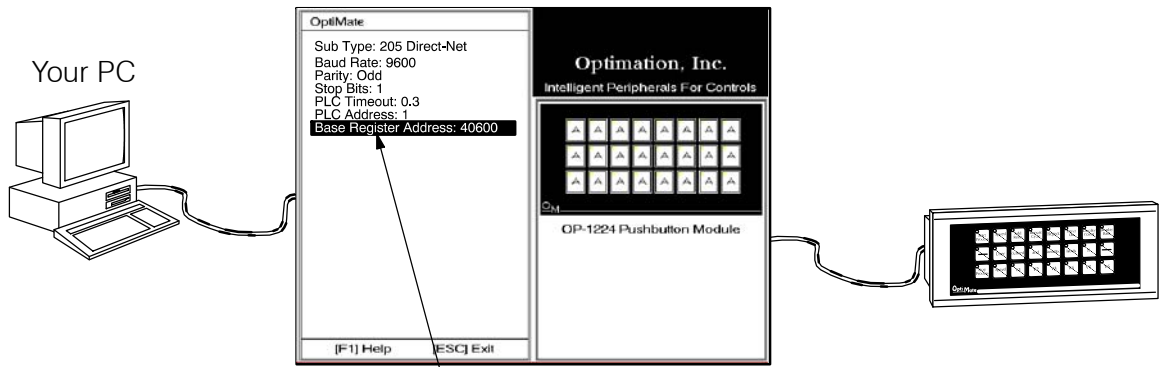

During configuration, you determine the starting address for the memory mapping process.

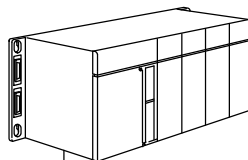

### Mapping Assignments

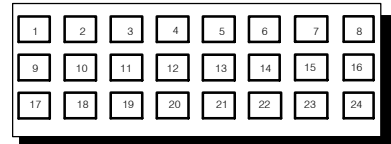

#### DirectLOGIC

Mapped Memory Location	Function
m (such as V40600) C0-C17	Pushbuttons 1-16 ON/OFF
m+1 (such as V40601) C20-C37	Pushbuttons 17-24 ON/OFF
m+2 (such as V40602) C40-C57	LEDs 1-16 flash
m+3 (such as V40603) C60-C77	LEDs 17-24 flash
m+4 (such as V40604) C100-C117	LEDs 1-16 ON/OFF
m+5 (such as V40605) C120-C137	LEDs 17-24 ON/OFF
m+6 (such as V40606) C140-C157	Force Function Data (1-16)
m+7 (such as V40607) C160-C177	Force Function Mode/Data (17-24)

The pushbuttons are numbered left to right starting in the upper left corner.

#### Allen-Bradley

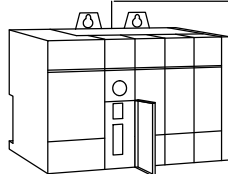

Mapped Memory Location	Function
m (such as N7: 0/0- 0/15)	Pushbuttons 1-16 ON/OFF
m+1 (such as N7: 1/0 1/15)	Pushbuttons 17-24 ON/OFF
m+2 (such as N7: 2/0 2/15)	LEDs 1-16 flash
m+3 (such as N7: 3/0 3/15)	LEDs 17-24 flash
m+4 (such as N7: 4/0 4/15)	LEDs 1-16 ON/OFF
m+5 (such as N7: 5/0 5/15)	LEDs 17-24 ON/OFF
m+6 (such as N7: 6/0 6/15)	Force Function Data (1-16)
m+7 (such as N7: 7/0 7/15)	Force Function Mode/Data (17-24)

### Addressing Conventions

Before getting into the ladder logic programming, take a moment to review and compare the addressing conventions used by **Direct**LOGIC and Allen-Bradley.

**DirectLOGIC Memory**—A typical address within a **Direct**LOGIC PLC is Vxxxx (such as V40600 for the DL05, DL06, DL105, DL205, DL350 or DL405 families) or Rxxx (such as R16 for the DL330/340 family). The V-memory in the DL05, DL06, DL105, DL350, DL205 and DL405 is divided into 16-bit boundaries, and the R-memory in the DL330/340 is divided into 8-bit boundaries. Refer to your individual User Manuals for complete memory information. The two diagrams below are examples how the lamps of the OP-1224 could be mapped during configuration. In the examples, V40600 and R16 have been chosen as starting boundaries to map the pushbuttons to the PLC, but any available user or internal relay memory areas can be used as long as they are consecutive:

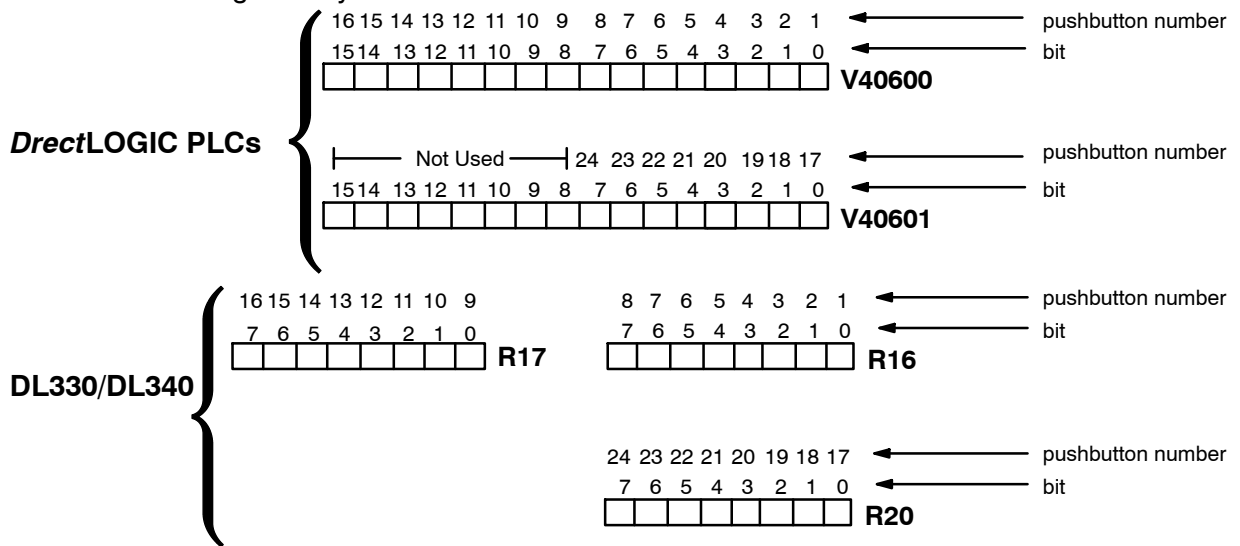

**Allen-Bradley Memory**—A typical address for Allen-Bradley might be N7:0/0 or N27:0/0. The OP-1224 will allow you to define a starting address for mapping purposes using either Allen-Bradley's integer (N7) file type or user-defined integer file types (N9–N255). *If you plan to use an integer file between N9 and N255, you must define these in the Allen-Bradley memory map before configuring the panel.* The example below shows how 16-bit integer files could be used to map the pushbuttons to the Allen-Bradley PLC.

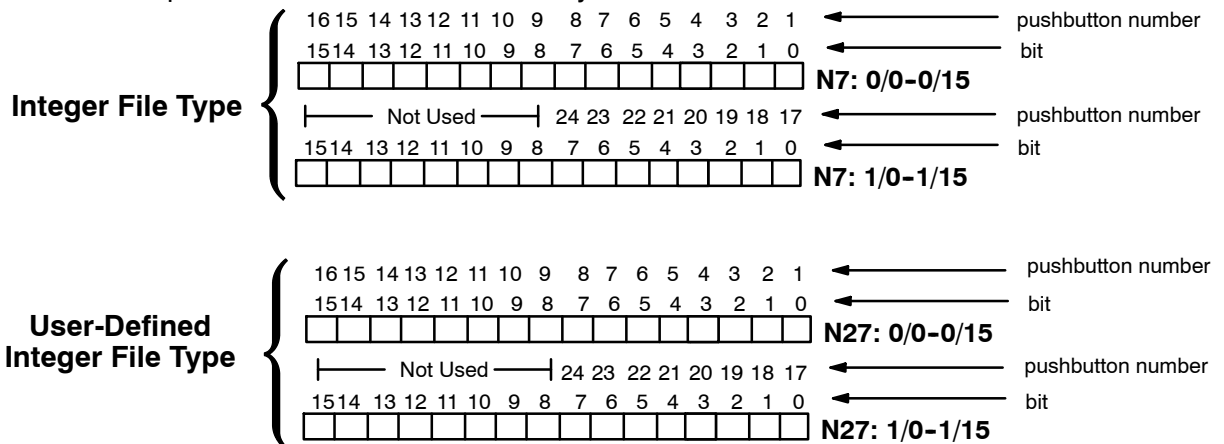

**Three Different Ways to Use the Panel** Depending on the type of CPU and the number of OP-1224 functions selected, there are three different ways to interface your ladder logic with the panel.

1. **Bit-of-Word**
2. **Internal Relays**
3. **User Memory Combined with Internal Relays**

Which of these methods is best for you depends on the make and model of the PLC being used. Look at each of these three methods to see what their relative merits are.

**Method 1:**  
**Bit-of-Word**  
**DL05/DL06/DL250/**  
**DL350/450 and**  
**Allen-Bradley**

The most direct way to address the individual bits with ladder logic is to use “bit-of-word”. This method is available with the DL05/DL06/DL250/DL350/DL450, *Direct*LOGIC, PLCs and SLC 5/03 and 5/04, Allen-Bradley, PLCs. Below is a rung of logic that shows how the DL05/DL06/DL250/DL350/DL450 might use the status of bit 3 to control a process connected to Y12. **Refer to pages 18-22 for DL05/DL06/DL250/350/450 examples, and pages 37-41 for Allen-Bradley.**

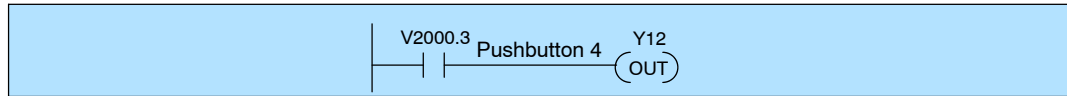

**Method 2:**  
**Internal Relays**  
**(All Options Used)**

This method is only available to *Direct*LOGIC PLCs. If you are familiar with the DL05, DL06 DL105, DL205, DL305 and DL405 PLCs, then you know about internal relays. These relays, by PLC design, are mapped to certain bits in reserved memory areas. You can make use of these relays during configuration with OP-WINEDIT by mapping directly to the control relay reserved memory area. **This method should only be used if you plan to use all of the functions of the panel; otherwise it will consume internal relays unnecessarily.** Using this method automatically consumes 128 internal relays. One of the mapped pushbuttons is used to control the output Y12 in the example below. **Refer to Pages 23-27.**

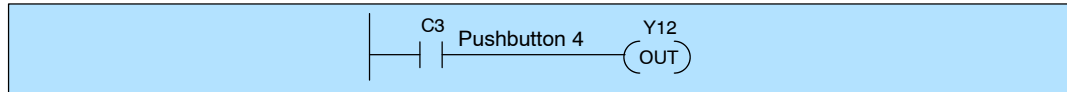

**Method 3:**  
**Remapping**  
**(Selected Options)**

A better way to make use of internal relays when not using all of the OP-1224 options is to use a process of “remapping”. With this technique the panel is mapped to user memory (such as V2000), then parts of the user memory are mapped only to those relays that are actually being used. The example below shows ladder logic necessary to detect when a pushbutton has been pressed. It maps V2000/V2001 to V40600/V40601 and consumes only 32 relays. It uses only the relays necessary for the option you have selected. This will become clearer with specific ladder logic examples that use this technique. **By convention, this manual uses syntax of the form V2000:V40600 to refer to memory locations that have been mapped together. Refer to Pages 28-33 for ladder logic examples.**

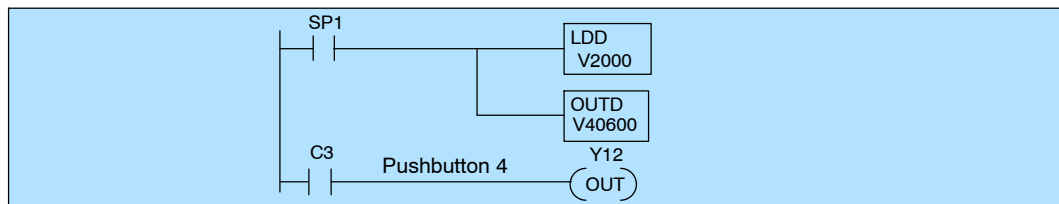

# Using the OP-1224 with the *Direct*LOGIC PLCs

## Using Pushbutton Status with Ladder Logic

By convention, the letter “m” is used to refer to consecutive memory locations in the PLC. Memory locations **m** and **m+1** reflect the state of the pushbuttons. If you have a *Direct*LOGIC PLC (DL05, DL06, DL250, DL350 or DL450), the status of the individual bits of these two words is easily determined by using the bit-of-word instruction. The example shown below uses a base register address of V2000 to map the status of the pushbuttons. When Pushbutton 3 is pressed it affects bit 2 of V2000. Likewise, Pushbutton 4 affects bit 3. Pushbutton 23 affects bit 6 of V2001.

**DL05/DL06/DL250/DL350/DL450**

	Mapped Memory Location	Function
m	V2000	Pushbuttons 1-16 ON/OFF
m+1	V2001	Pushbuttons 17-24 ON/OFF
m+2	V2002	LEDs 1-16 flash
m+3	V2003	LEDs 17-24 flash
m+4	V2004	LEDs 1-16 ON/OFF
m+5	V2005	LEDs 17-24 ON/OFF
m+6	V2006	Force Function Data (1-16)
m+7	V2007	Force Function Mode/Data (17-24)

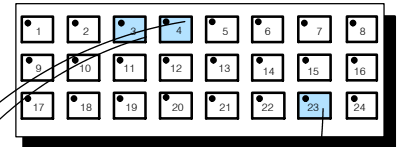

DL05/DL06/DL250/  
DL350/DL450

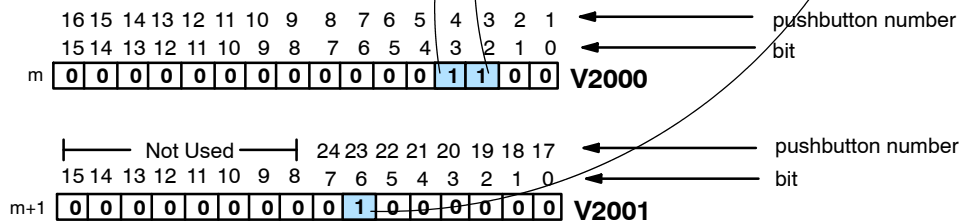
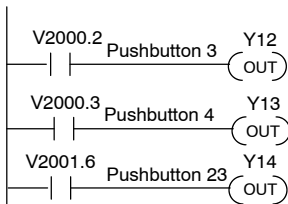

**NOTE:** The DL105 does not support bit-of-word functions.

**Controlling LEDs Separately with the DirectLOGIC PLCs**

By default, the LED shows the state of the pushbutton—ON or OFF. If a pushbutton is configured for momentary operation, there are two options available for the LED. It can show the state of the pushbutton or it can be controlled independently by enabling the **LED Separation** feature. When the LED Separation feature is enabled, the ON/OFF state of the LED is controlled only by the status of the bits in **m+4** and **m+5**. These bits can be manipulated with ladder logic.

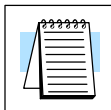

**NOTE:** Any pushbutton configured for maintained (alternate action) will ignore the bits in these two words.

In the example below, the bit-of-word instruction controls LEDs 3, 4 and 23 when V2000 has been designated as the base address during configuration with OP-WINEDIT. X12 turns ON LED3, X13 turns ON LED4, and X14 turns ON LED23.

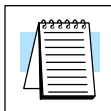

**NOTE:** Independent control of the LEDs can only be accomplished LED Separation has been enabled during initial configuration.

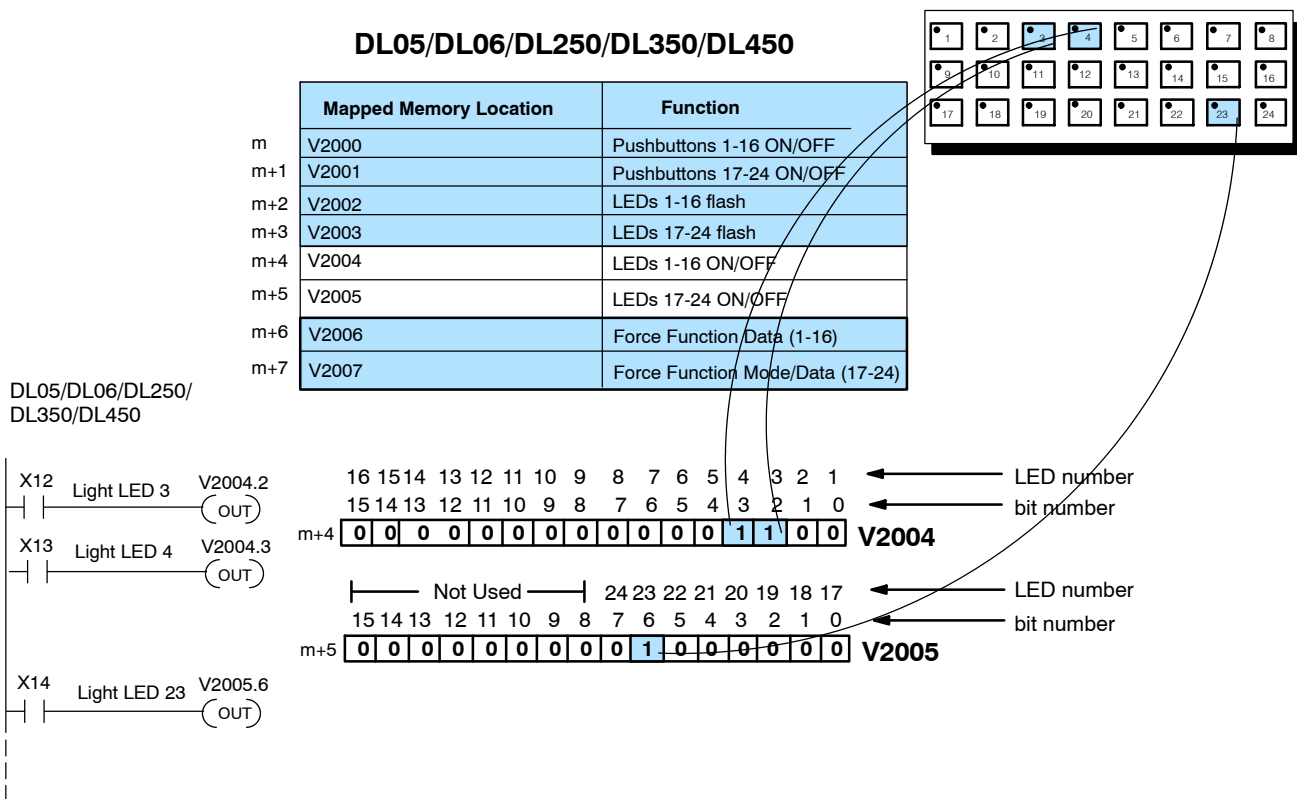

**NOTE:** The DL105 does not support bit-of-word functions.

**Add Flashing with the DL05/DL06/DL250/DL350/DL450**

If this feature is used with one or more pushbuttons, there are three things you must always remember during configuration:

1. Flashing is only available for those buttons that have been configured as **Momentary**.
2. **LED Separation** must be enabled.
3. The **Flash Option** must be enabled.

The flashing option is triggered through ladder logic. The previous page, showed how to turn ON an LED; this example shows how to add flashing to an LED that has been turned ON. The flashing feature is controlled by the status of the bits in **m+2** and **m+3** memory areas. The example below, mapping begins at V2000 during initial configuration. LED4 is turned ON and then made to flash. Bit 3 of V2004 turns the LED ON, and bit 3 or V2002 makes it flash.

**DL05/DL06/DL250/DL350/DL450 Only**

Mapped Memory Location	Function
m V2000	Pushbuttons 1-16 ON/OFF
m+1 V2001	Pushbuttons 17-24 ON/OFF
m+2 V2002	LEDs 1-16 flash
m+3 V2003	LEDs 17-24 flash
m+4 V2004	LEDs 1-16 ON/OFF
m+5 V2005	LEDs 17-24 ON/OFF
m+6 V2006	Force Function Data (1-16)
m+7 V2007	Force Function Mode/Data (17-24)

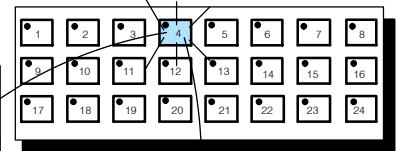

DL05/DL06/  
DL250/DL350/  
DL450 Only

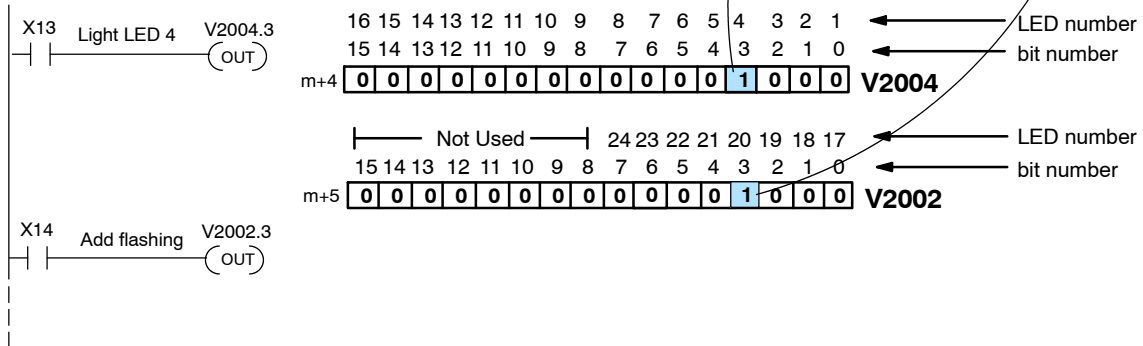

**NOTE:** The DL105 does not support bit-of-word functions.

**Force Function Registers**



The OP-1224 has the ability to “force” a pushbutton ON or OFF with ladder logic. If this function is used, the force option must be enabled during configuration.

**NOTE:** The force function will only work for those pushbuttons that are configured as “maintained” (alternate action). It will not work for momentary pushbuttons.

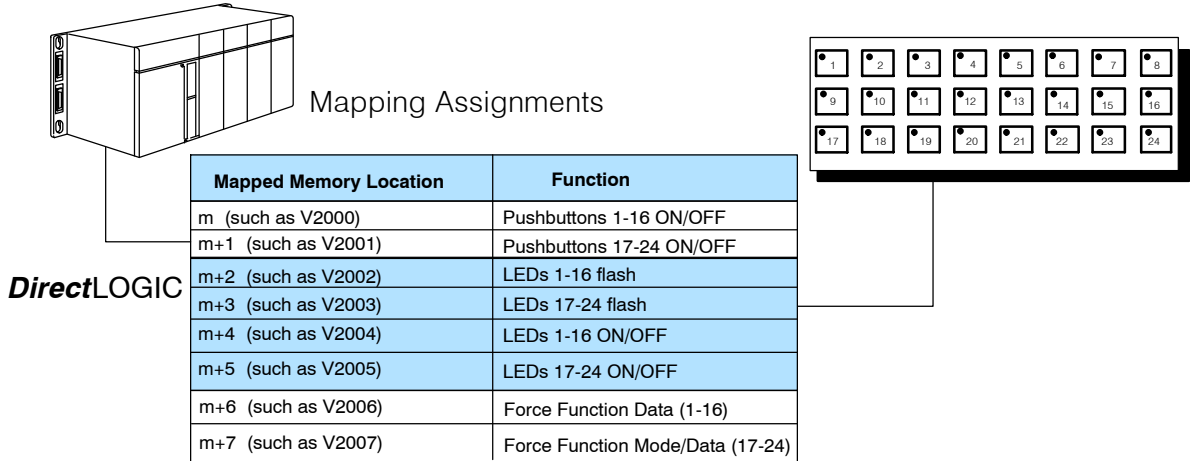

**How the Memory is Used**-Looking at the above memory map, **m+6** stores the forcing data for Pushbuttons 1-16 and **m+7** stores forcing data for Pushbuttons 17-24. There are three modes of the force function. These modes are controlled by the 3 most significant bits of m+7.

**Mode 1 (M1)**- This forces all of the Pushbuttons to reflect the status stored in m+6 and m+7. For example, the data shown below would force Pushbuttons 3, 4 and 23 to ON and all the others would be forced OFF. Notice that bit 15 of m +7 is set to 1 for this mode. M2 and M3 are set to 0's.

**Mode 2 (M2)**- This forces ON only those Pushbuttons matching the bits set in registers m+6 and m+7. The bits not set do not affect the status of the Pushbuttons. You would set M2 to 1 while M1 and M3 are set to 0.

**Mode 3 (M3)**- This forces OFF only those Pushbuttons matching the bits set in registers m+6 and m+7. The bits not set do not affect the status of the Pushbuttons. You would set M3 to 1, while M1 and M2 are set to 0.

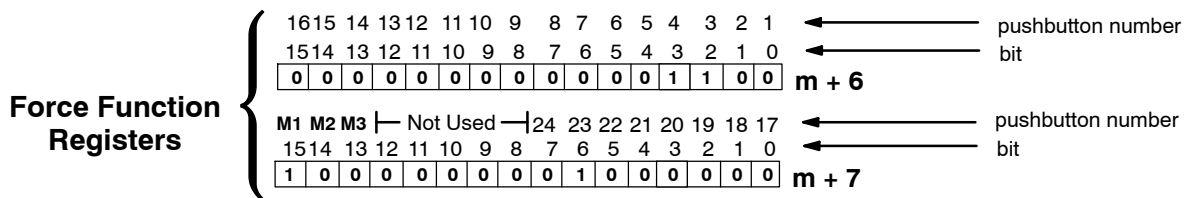

Think of forcing as a one-shot process. That is, once the mode has been set in m+7, the bit patterns in m and m+1 are changed (according to the mode selected), and then, all of the bits in m+6 and m+7 are set to zero. What this means is that all pushbuttons return to normal manual operation after the forcing is completed.

### Forcing Pushbuttons ON/OFF with DirectLOGIC PLCs

Bit-of-word can also be used with the DL05/DL06/DL250/DL350/DL450 to force pushbuttons ON or OFF. In the following example, V2000 was chosen during configuration as the base address for the mapping in the PLC. In this example, Pushbutton 14 is used to start a process, then force the pushbutton OFF when the process is completed. Memory location **m** (V2000 in this case) holds the bit that reflects the status of Pushbutton 14. Memory locations **m+6** and **m+7** hold the data for the forcing. Here we have chosen to use Mode 3. With this mode, whichever bits are set to 1 in m+6 and m+7, the corresponding pushbuttons will be forced to OFF. In the following example, we only set bit 13 in m+6; so only Pushbutton 14 is turned OFF.

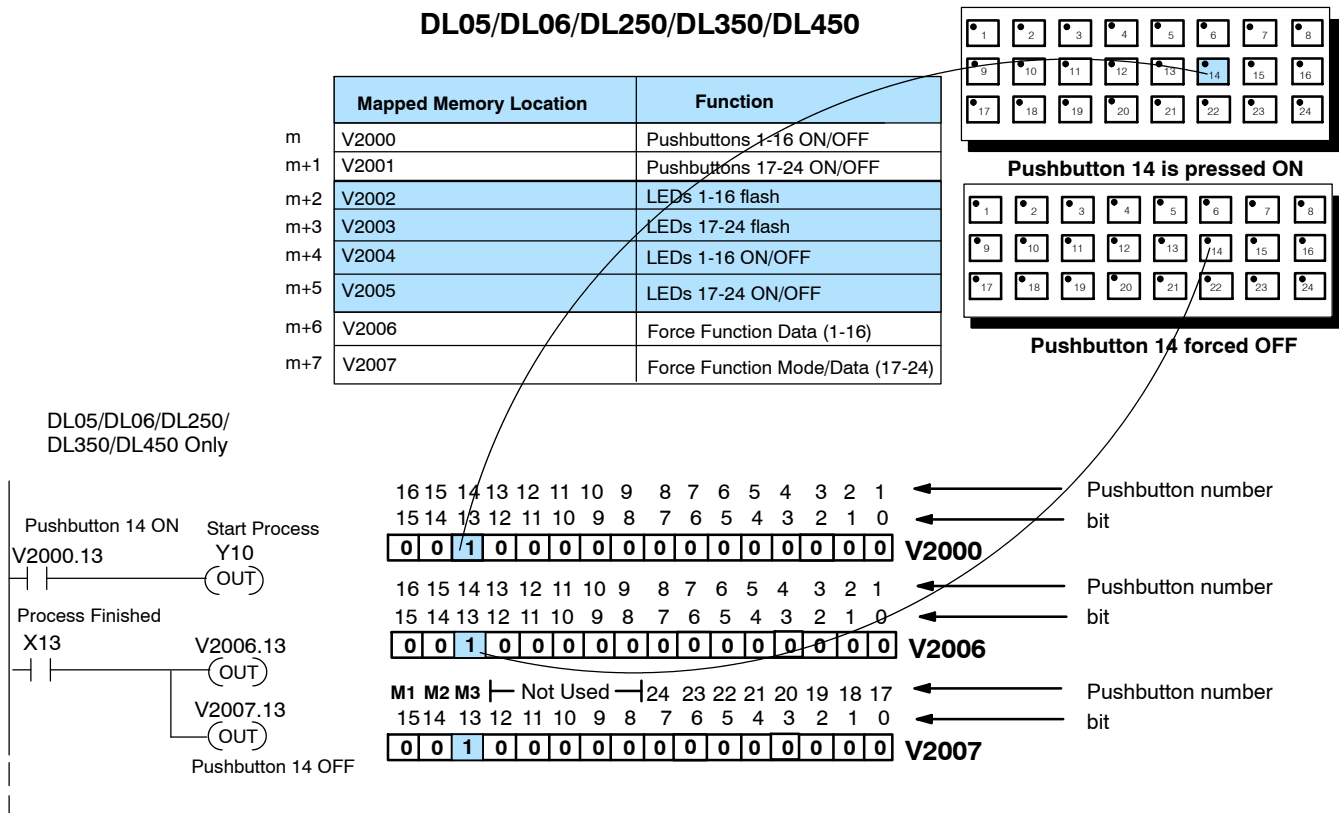

**NOTE:** The DL105 does not support bit-of-word functions.



# DirectLOGIC PLCs (Using All Functions)

## Using Pushbutton Status Via Ladder Logic

To configure the OP1224, a base address must be chosen in the CPU. This address can be a direct mapping to the reserved memory locations that are tied to internal relays. The internal relays of the DL05, DL06, DL105, DL205, DL350 and DL405 families start at V40600 and the internal relays of the DL305 family start at R16. Using this method, the total mapping consumes 128 internal relays. This method should only be used when using all of the OP-1224 functions. In the examples below, V40600 is selected as the starting address for either a DL05, DL06, DL105, DL205, DL350 or DL405. R16 has been selected as the starting address for the DL305. *Notice that the internal control relays are numbered in octal and not decimal.* In the examples below, the ladder logic is interacting with Pushbuttons 3, 4 and 23.

**DL05/DL06/DL105/DL205/DL350/DL405**

**DirectLOGIC PLCs**

	Mapped Memory Location	Function
m	V40600 (C0-C17)	Pushbuttons 1-16 ON/OFF
m+1	V40601 (C20-C37)	Pushbuttons 17-24 ON/OFF
m+2	V40602 (C40-C57)	LEDs 1-16 flash
m+3	V40603 (C60-C77)	LEDs 17-24 flash
m+4	V40604 (C100-C117)	LEDs 1-16 ON/OFF
m+5	V40605 (C120-C137)	LEDs 17-24 ON/OFF
m+6	V40606 (C140-C157)	Force Function Data (1-16)
m+7	V40607 (C160-C177)	Force Function Mode/Data (17-24)

	16 15 14 13 12 11 10 9 8 7 6 5 4 3 2 1		8 7 6 5 4 3 2 1		
	17 16 15 14 13 12 11 10 7 6 5 4 3 2 1 0		24 23 22 21 20 19 18 17		
m	0 0 0 0 0 0 0 0 0 0 0 0 0 0 0 0		1 1 0 0		<b>V40600</b>
	Not Used		1 0 0 0 0 0 0 0		<b>V40601</b>

**DL330/340 PLCs**

**DL330/340**

	Example Memory Locations	Function
m	R16/R17 (C160 to C177)	Pushbuttons 1-16 ON/OFF
m+1	R20/R21 (C200 to C217)	Pushbuttons 17-24 ON/OFF
m+2	R22/R23 (C220 to C237)	LEDs 1-16 flash
m+3	R24/R25 (C240 to C257)	LEDs 17-24 flash
m+4	R26/R27 (C260 to C277)	LEDs 1-16 ON/OFF
m+5	R30/R31 (C300 to C317)	LEDs 17-24 ON/OFF
m+6	R32/R33 (C320 to C337)	Force Function Data (1-16)
m+7	R34/R35 (C340 to C357)	Force Function Mode/Data (17-24)

	16 15 14 13 12 11 10 9		8 7 6 5 4 3 2 1		
	7 6 5 4 3 2 1 0		24 23 22 21 20 19 18 17		
	0 0 0 0 0 0 0 0		1 1 0 0		<b>R16</b>
	Not Used		1 0 0 0 0 0 0 0		<b>R20</b>

**Note:** To determine the control relay number, use the register number as the first two digits and the bit number as the last digit. For example, Bit 3 of R16 is referenced as C163.

**Controlling LEDs Separately**

By default, the LED shows the state of the pushbutton-ON or OFF. If a pushbutton is configured for momentary operation, there are two options available for the LED. It can show the state of the pushbutton or it can be controlled independently by enabling the **LED Separation** feature. When the LED Separation feature has been enabled, the ON/OFF state of the LED is controlled only by the status of the bits in **m+4** and **m+5**. These bits can be manipulated via the ladder logic. In the examples below, the ladder logic is controlling LEDs 3, 4 and 23.



**NOTE:** Any pushbutton configured for maintained (alternate action) will ignore the bits in these two words. Independent control of the LEDs can only be accomplished if LED Separation has been enabled during the initial configuration.

**DL05/DL06/DL105/DL205/DL350/DL405**

**DirectLOGIC PLCs**

X12 Light LED 3 C102 (OUT)

X13 Light LED 4 C103 (OUT)

X14 Light LED 23 C126 (OUT)

	Mapped Memory Location	Function
m	V40600 (C0-C17)	Pushbuttons 1-16 ON/OFF
m+1	V40601 (C20-C37)	Pushbuttons 17-24 ON/OFF
m+2	V40602 (C40-C57)	LEDs 1-16 flash
m+3	V40603 (C60-C77)	LEDs 17-24 flash
m+4	V40604 (C100-C117)	LEDs 1-16 ON/OFF
m+5	V40605 (C120-C137)	LEDs 17-24 ON/OFF
m+6	V40606 (C140-C157)	Force Function Data (1-16)
m+7	V40607 (C160-C177)	Force Function Mode/Data (17-24)

16 15 14 13 12 11 10 9 8 7 6 5 4 3 2 1 ← LED number

17 16 15 14 13 12 11 10 7 6 5 4 3 2 1 0 ← internal relay number

m+4 **0 0 0 0 0 0 0 0 0 0 0 0 0 1 1 0 0** **V40604** (Add number starting at C100)

Not Used | 24 23 22 21 20 19 18 17 ← LED number

17 16 15 14 13 12 11 10 7 6 5 4 3 2 1 0 ← internal relay number

m+5 **0 0 0 0 0 0 0 0 0 0 1 0 0 0 0 0 0** **V40605** (Add number starting at C120)

**DL330/340 PLCs**

**DL330/340**

IO12 Light LED 3 C262 (OUT)

IO13 Light LED 4 C263 (OUT)

IO14 Light LED 23 C306 (OUT)

	Example Memory Locations	Function
m	R16/R17 (C160 to C177)	Pushbuttons 1-16 ON/OFF
m+1	R20/R21 (C200 to C217)	Pushbuttons 17-24 ON/OFF
m+2	R22/R23 (C220 to C237)	LEDs 1-16 flash
m+3	R24/R25 (C240 to C257)	LEDs 17-24 flash
m+4	R26/R27 (C260 to C277)	LEDs 1-16 ON/OFF
m+5	R30/R31 (C300 to C317)	LEDs 17-24 ON/OFF
m+6	R32/R33 (C320 to C337)	Force Function Data (1-16)
m+7	R34/R35 (C340 to C357)	Force Function Mode/Data (17-24)

16 15 14 13 12 11 10 9 8 7 6 5 4 3 2 1 ← LED number

7 6 5 4 3 2 1 0 ← internal relay number

**0 0 0 0 0 0 0 0 0 0 0 0 0 0 0 0** **R27**     **0 0 0 0 1 1 0 0** **R26**

Not Used | 24 23 22 21 20 19 18 17 ← LED number

7 6 5 4 3 2 1 0 ← internal relay number

**0 0 0 0 0 0 0 0 0 0 0 0 0 0 0 0** **R31**     **0 1 0 0 0 0 0 0** **R30**

**Note:** To determine the control relay number, use the register number as the first two digits and the bit number as the last digit. For example, Bit 3 of R26 is referenced as C263.

**Adding Flashing**

If using this feature with one or more pushbuttons, there are three things to remember during configuration:

1. Flashing is only available for those buttons that have been configured as **Momentary**.
2. **LED Separation** must be enabled.
3. The **Flash Option** must be enabled.

The flashing option is triggered through the ladder logic. On the previous page, the example illustrated how to turn ON an LED, this example illustrates how to add flashing to an LED that has been turned ON. The flashing feature is controlled by the status of the bits in **m+2** and **m+3** memory areas. The example below begins mapping at V40600 with the initial configuration. LED4 is turned ON and then made to flash. Bit 3 of **m+4** turns the LED ON, and bit 3 of **m+2** causes it to flash.

**DL05/DL06/105/DL205/DL350/DL405**

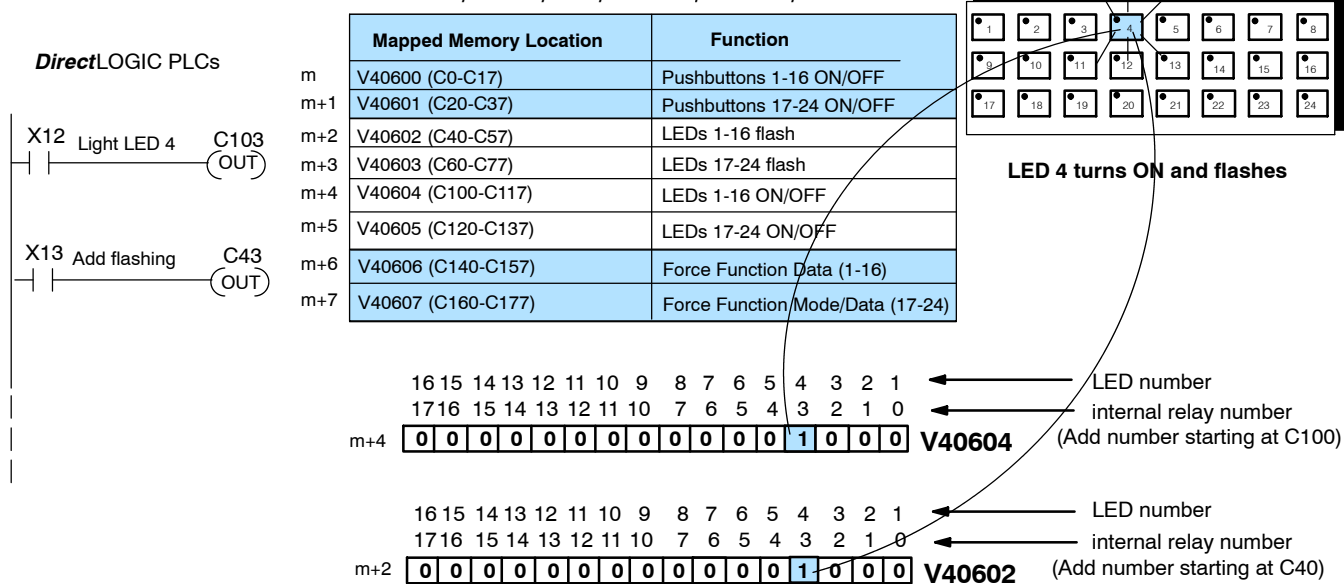

**DL330/340 PLCs**

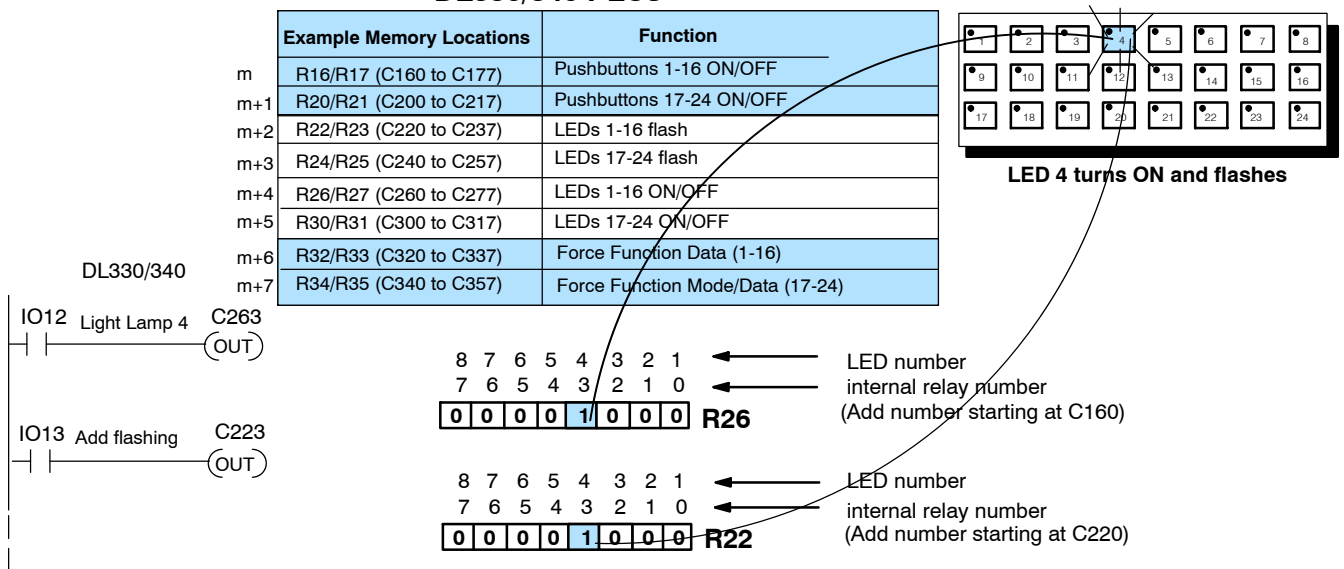

**Force Function Registers**



The OP-1224 has the ability to “force” a pushbutton ON or OFF with ladder logic. If this function is used, the force option must be enabled during configuration.

**NOTE:** The force function will only work for those pushbuttons that are configured as “maintained” (alternate action). It will not work for momentary pushbuttons.

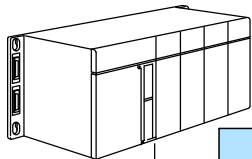

DirectLOGIC

Mapping Assignments

Mapped Memory Location	Function
m (such as V40600, C0-C17)	Pushbuttons 1-16 ON/OFF
m+1 (such as V40601, C20-C37)	Pushbuttons 17-24 ON/OFF
m+2 (such as V40602, C40-C57)	LEDs 1-16 flash
m+3 (such as V40600, C60-C77)	LEDs 17-24 flash
m+4 (such as V40604, C100-C117)	LEDs 1-16 ON/OFF
m+5 (such as V40605, C120-C137)	LEDs 17-24 ON/OFF
m+6 (such as V40606, C140-C157)	Force Function Data (1-16)
m+7 (such as V40607, C160-C177)	Force Function Mode/Data (17-24)

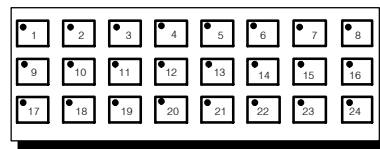

**How the Memory is Used**—Looking at the above memory map, **m+6** stores the forcing data for pushbuttons 1-16 and **m+7** stores forcing data for pushbuttons 17-24. There are three modes of the force function. These modes are controlled by the 3 most significant bits of m+7.

**Mode 1 (M1)**— This forces all of the pushbuttons to reflect the status stored in m+6 and m+7. For example, the data shown below would force pushbuttons 3, 4 and 23 to ON and all the others would be forced OFF. Notice that bit 15 of m+7 is set to 1 for this mode. M2 and M3 are set to 0’s.

**Mode 2 (M2)**— This forces ON only those pushbuttons matching the bits set in registers m+6 and m+7. The bits not set do not affect the status of the pushbuttons. You would set M2 to 1 while M1 and M3 are set to 0.

**Mode 3 (M3)**— This forces OFF only those pushbuttons matching the bits set in registers m+6 and m+7. The bits not set do not affect the status of the pushbuttons. You would set M3 to 1 while M1 and M2 are set 0.

**Force Function Registers for DirectLOGIC PLCs**

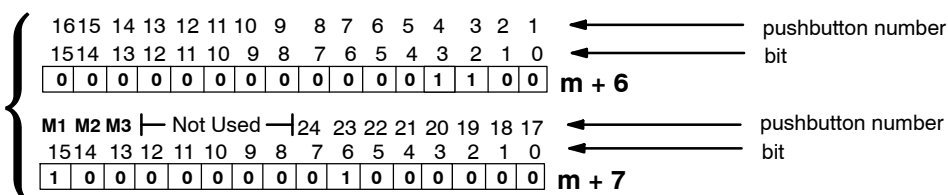

**Force Function Registers for DL330/340**

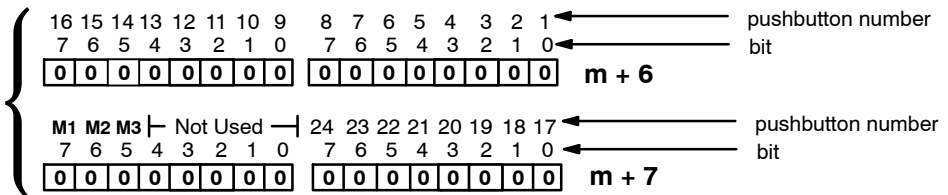

**Think of forcing as a one-shot process. That is, once the mode has been set in m+7, the bit patterns in m and m+1 are changed (according to the mode selected), then, all of the bits in m+6 and m+7 are set to zero. What this means is that all pushbuttons return to normal manual operation after the forcing is completed.**

**Forcing Pushbuttons ON or OFF**

In this example, Mode 3 of the force function is used to force Pushbutton 14 OFF when a process has been completed. Be sure to read Page 28 to learn the function of all three modes. For the **DirectLOGIC** PLC example, a base address of V40600 is used. R16 is used for the DL305 PLCs.

**DL05/DL06/DL105/DL205/DL350/DL405**

	Mapped Memory Location	Function
m	V40600 (C0-C17)	Pushbuttons 1-16 ON/OFF
m+1	V40601 (C20-C37)	Pushbuttons 17-24 ON/OFF
m+2	V40602 (C40-C57)	LEDs 1-16 flash
m+3	V40603 (C60-C77)	LEDs 17-24 flash
m+4	V40604 (C100-C117)	LEDs 1-16 ON/OFF
m+5	V40605 (C120-C137)	LEDs 17-24 ON/OFF
m+6	V40606 (C140-C157)	Force Function Data (1-16)
m+7	V40607 (C160-C177)	Force Function Mode/Data (17-24)

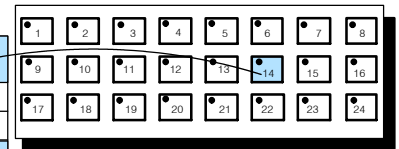

Pushbutton 14 is pressed ON

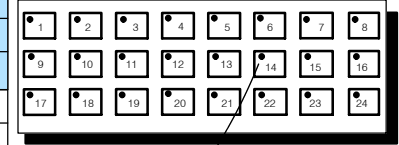

Pushbutton 14 forced OFF

**DirectLOGIC PLCs**

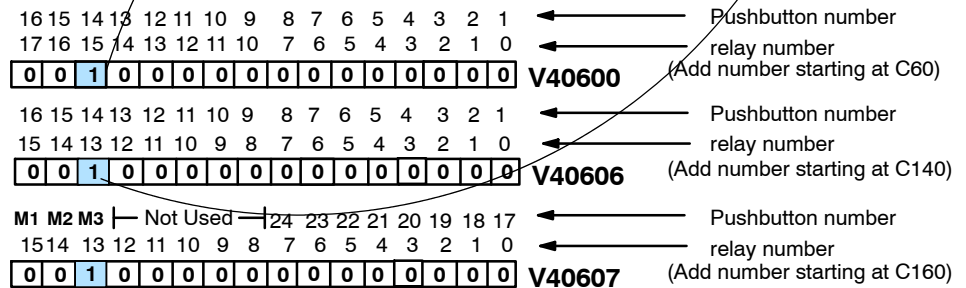
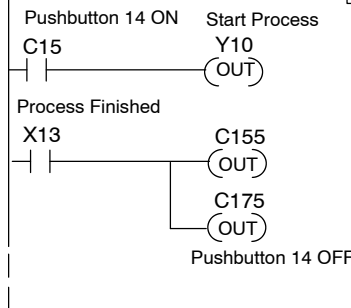

**DL330/340 PLCs**

	Example Memory Locations	Function
m	R16/R17 (C160 to C177)	Pushbuttons 1-16 ON/OFF
m+1	R20/R21 (C200 to C217)	Pushbuttons 17-24 ON/OFF
m+2	R22/R23 (C220 to C237)	LEDs 1-16 flash
m+3	R24/R25 (C240 to C257)	LEDs 17-24 flash
m+4	R26/R27 (C260 to C277)	LEDs 1-16 ON/OFF
m+5	R30/R31 (C300 to C317)	LEDs 17-24 ON/OFF
m+6	R32/R33 (C320 to C337)	Force Function Data (1-16)
m+7	R34/R35 (C340 to C357)	Force Function Mode/Data (17-24)

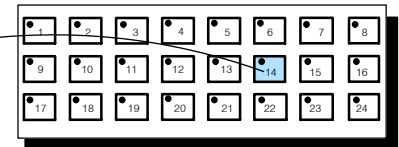

Pushbutton 14 is pressed ON

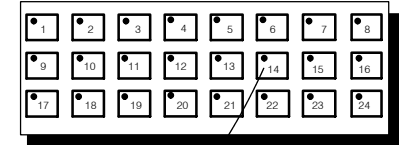

Pushbutton 14 forced OFF

**DL330/340**

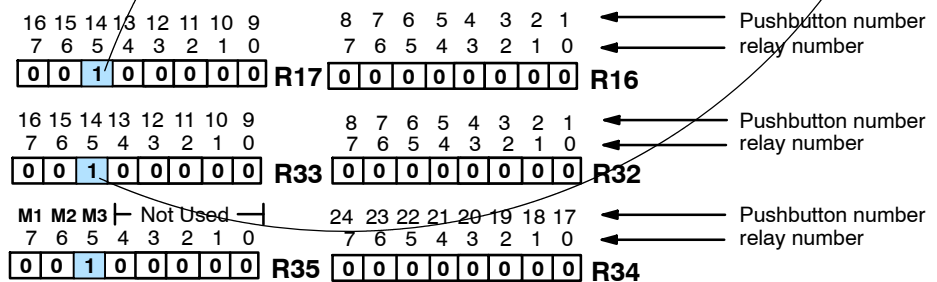
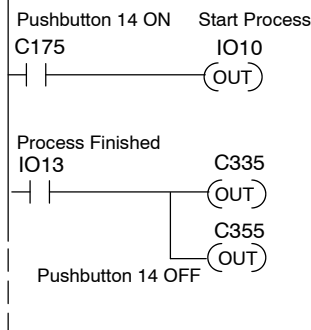

**Note:** To determine the control relay number, use the register number as the first two digits and the bit number as the last digit. For example, Bit 5 of R33 is referenced as C335.

## Using Selected Functions with *DirectLOGIC* PLCs

### Using the Remapping Process

The “remapping” process was briefly discussed as a method that allows you to easily manipulate individual bits to take advantage of the panels many functions. All the functions are bit-controlled. By using this method, the number of relays actually needed for the functions selected are consumed.

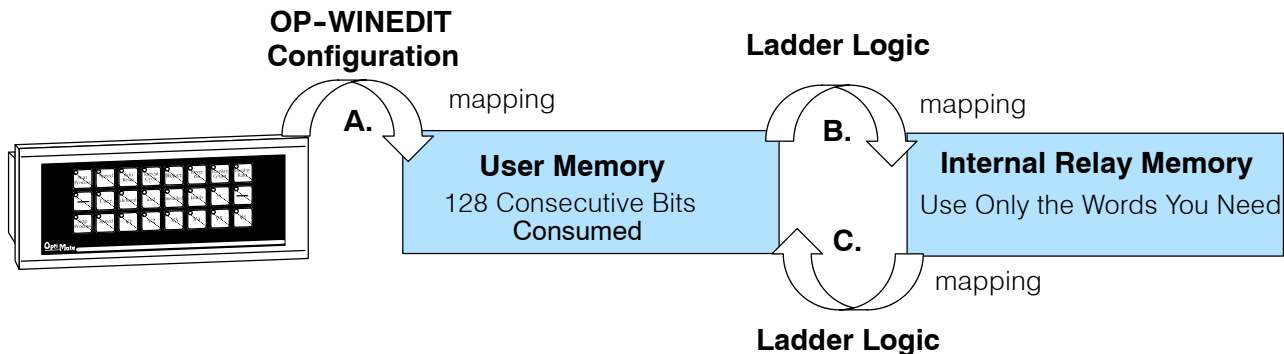

Using the remapping method, first indicate a base register address with the OP-WINEDIT software and download it to the panel. The panel configuration will automatically consume 128 consecutive memory bits in the PLC User Memory. This is indicated by the arrow A. But since User Memory doesn't provide bit control, the User Memory needs to be remapped with Internal Relay Memory. By remapping between User Memory and Internal Relay Memory, only the Relay Memory you need is consumed. There are two directions in which the ladder logic can do the remapping between User Memory and Internal Relay Memory:

1. For using the Pushbutton Status to control outputs, ladder logic needs to be written to map User Memory to Internal Relay Memory (arrow B). This affects the User Memory in the  $m$  and  $m+1$  locations.
2. For controlling all other functions of the panel, ladder logic needs to be written to map Internal Relay Memory to User Memory (arrow C). This affects the User Memory in locations  $m+2$  through  $m+7$ .

Below are two examples of remapping accomplished with ladder logic that demonstrate the two types of remapping that can be used with this technique. Assume that V2000 was used as the base register address:

#### Example of User Memory being mapped to Internal Relay Memory

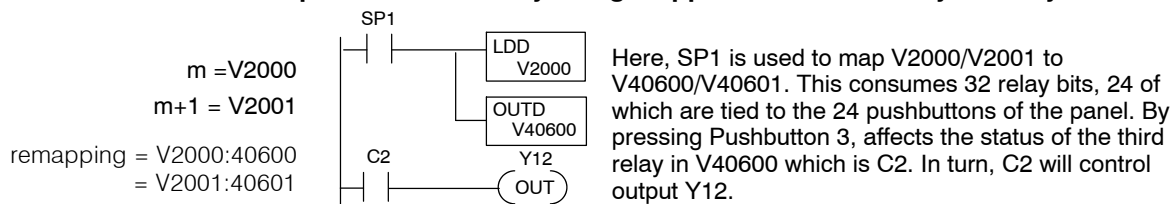

#### Example of Internal Relay Memory being mapped to User Memory

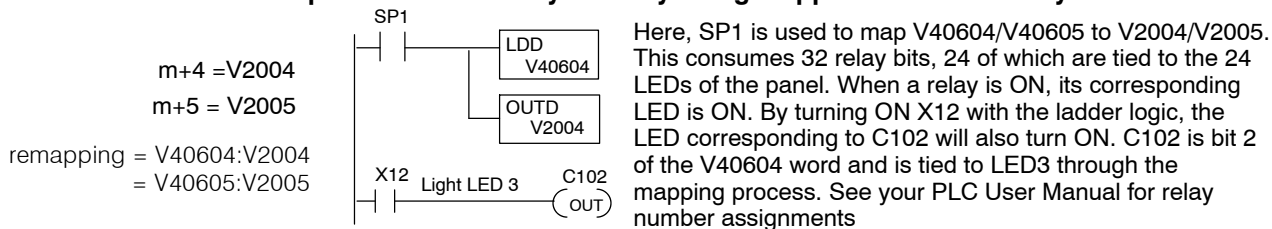

**Using Pushbutton Status via Ladder Logic**

In this example, user memory will be remapped to internal relay memory in order to use the the pushbutton status to control outputs. The internal relays of **DirectLOGIC** PLCs start at V40600 and the internal relays of the DL305 family start at R16. In the examples below, V2000 is selected as the base address for either a **DirectLOGIC** and SP1 (always ON relay) is used in the ladder logic to map it to V40600. R400 is the base address selected for the DL305 and used normally closed C374 in the ladder logic to map it to R16. Using SP1 and normally closed C374, the remapping is done every scan, otherwise m and m+1 would not be updated. In the examples below, the ladder logic is interacting with Pushbuttons 3, 4 and 23.

**DirectLOGIC**

**DL05/DL06/DL105/DL205/DL350/DL405**

Mapped Memory Location	Function
m V2000:V40600	Pushbuttons 1-16 ON/OFF
m+1 V2001:V40601	Pushbuttons 17-24 ON/OFF
m+2 V2002	LEDs 1-16 flash
m+3 V2003	LEDs 17-24 flash
m+4 V2004	LEDs 1-16 ON/OFF
m+5 V2005	LEDs 17-24 ON/OFF
m+6 V2006	Force Function Data (1-16)
m+7 V2007	Force Function Mode/Data (17-24)

Syntax shown in the form of V2000:V40600 refers to two memory locations that have been mapped together.

16 15 14 13 12 11 10 9 8 7 6 5 4 3 2 1 ← pushbutton number  
 17 16 15 14 13 12 11 10 7 6 5 4 3 2 1 0 ← internal relay number  
 m 0 0 0 0 0 0 0 0 0 0 0 0 0 0 1 1 0 0 V2000:V40600

Not Used 24 23 22 21 20 19 18 17 ← pushbutton number  
 37 36 35 34 33 32 31 30 27 26 25 24 23 22 21 20 ← internal relay number  
 m+1 0 0 0 0 0 0 0 0 0 0 0 1 0 0 0 0 0 0 V2001:V40601

**DL330/340 PLCs**

Example Memory Locations	Function
m R400/R401:R16/R17	Pushbuttons 1-16 ON/OFF
m+1 R402/R403:R20/R21	Pushbuttons 17-24 ON/OFF
m+2 R404/R405	LEDs 1-16 flash
m+3 R406/R407	LEDs 17-24 flash
m+4 R410/R411	LEDs 1-16 ON/OFF
m+5 R412/R413	LEDs 17-24 ON/OFF
m+6 R414/R415	Force Function Data (1-16)
m+7 R416/R417	Force Function Mode/Data (17-24)

Syntax shown in the form of R400/R401:R16/R17 refers to two consecutive memory registers mapped to two other consecutive memory registers.

16 15 14 13 12 11 10 9 8 7 6 5 4 3 2 1 ← pushbutton number  
 7 6 5 4 3 2 1 0 7 6 5 4 3 2 1 0 ← internal relay number  
 0 0 0 0 0 0 0 0 0 0 0 0 0 1 1 0 0 0 R401:R17 0 0 0 0 1 1 0 0 R400:R16

Not Used 24 23 22 21 20 19 18 17 ← pushbutton number  
 7 6 5 4 3 2 1 0 7 6 5 4 3 2 1 0 ← internal relay number  
 0 0 0 0 0 0 0 0 0 0 0 1 0 0 0 0 0 0 R403:R21 0 1 0 0 0 0 0 0 R402:R20

**Note:** To determine the control relay number, use the register number as the first two digits and the bit number as the last digit. For example, Bit 3 of R16 is referenced as C163.

**Controlling LEDs Separately**

By default, the LED will show the state of the pushbutton-ON or OFF. If a pushbutton is configured for momentary operation, there are two options available for the LED. It can show the state of the pushbutton or it can be controlled independently by enabling the **LED Separation** feature. When the LED Separation feature is enabled, the ON/OFF state of the LED is controlled only by the status of the bits in **m+4** and **m+5**. These bits can be manipulated via your ladder logic. In the examples below, the user memory has been remapped to control relay memory to control LEDs 3, 4 and 23.



**NOTE:** Any pushbutton configured for maintained (alternate action) will ignore the bits in these two words. Independent control of the LEDs can only be accomplished if LED Separation has been enabled during the initial configuration.

**DL05/DL06/DL105/DL205/DL350/DL405**

**DirectLOGIC PLCs**

Mapped Memory Location	Function
m V2000	Pushbuttons 1-16 ON/OFF
m+1 V2001	Pushbuttons 17-24 ON/OFF
m+2 V2002	LEDs 1-16 flash
m+3 V2003	LEDs 17-24 flash
m+4 V40604:V2004	LEDs 1-16 ON/OFF
m+5 V40605:V2005	LEDs 17-24 ON/OFF
m+6 V2006	Force Function Data (1-16)
m+7 V2007	Force Function Mode/Data (17-24)

**Syntax shown in the form of V2000:V40600 refers to two memory locations that have been mapped together.**

16 15 14 13 12 11 10 9 8 7 6 5 4 3 2 1 ← LED number  
 17 16 15 14 13 12 11 10 7 6 5 4 3 2 1 0 ← internal relay number (Add number starting at C100)  
 m+4 0 0 0 0 0 0 0 0 0 0 0 0 0 1 1 0 0 **V40604 :V2004**

24 23 22 21 20 19 18 17 ← LED number  
 17 16 15 14 13 12 11 10 7 6 5 4 3 2 1 0 ← internal relay number (Add number starting at C120)  
 m+5 0 0 0 0 0 0 0 0 0 0 1 0 0 0 0 0 0 **V40605 :V2005**

**DL330/340 PLCs**

**DL330/340 PLCs**

Example Memory Locations	Function
m R400/R401	Pushbuttons 1-16 ON/OFF
m+1 R402/R403	Pushbuttons 17-24 ON/OFF
m+2 R404/R405	LEDs 1-16 flash
m+3 R406/R407	LEDs 17-24 flash
m+4 R26/R27:R410/R411	LEDs 1-16 ON/OFF
m+5 R30/R31:R412/R413	LEDs 17-24 ON/OFF
m+6 R414/R415	Force Function Data (1-16)
m+7 R416/R417	Force Function Mode/Data (17-24)

**Syntax shown in the form of R400/R401:R16/R17 refers to two consecutive memory registers mapped to two other consecutive memory registers.**

16 15 14 13 12 11 10 9 8 7 6 5 4 3 2 1 ← LED number  
 7 6 5 4 3 2 1 0 ← internal relay number  
 0 0 0 0 0 0 0 0 0 0 0 0 0 1 1 0 0 **R27:R411** 0 0 0 0 1 1 0 0 **R26:R410**

24 23 22 21 20 19 18 17 ← LED number  
 7 6 5 4 3 2 1 0 ← internal relay number  
 0 0 0 0 0 0 0 0 0 0 1 0 0 0 0 0 0 **R31:R413** 0 1 0 0 0 0 0 0 **R30:R412**

**Note:** To determine the control relay number, use the register number as the first two digits and the bit number as the last digit. For example, Bit 3 of R26 is referenced as C263.



**Adding Flashing**

There are three things that must always be remembered when configuring the panel if the flashing feature is used with one or more pushbuttons:

1. Flashing is only available for those buttons that have been configured as **Momentary**.
2. **LED Separation** must be enabled.
3. The **Flash Option** must be enabled.

The flashing option is triggered through ladder logic. The example on the previous page, turned ON an LED. The following example will add flashing to an LED that has been turned ON. The flashing feature is controlled by the status of the bits in the **m+2** and **m+3** memory areas. The user memory has been mapped in these locations to internal relay memory. In the example below, mapping begins at V2000 during the initial configuration. LED4 is turned ON and then made to flash. Bit 3 of **m+4** turns the LED ON, and bit 3 of **m+2** makes it flash.

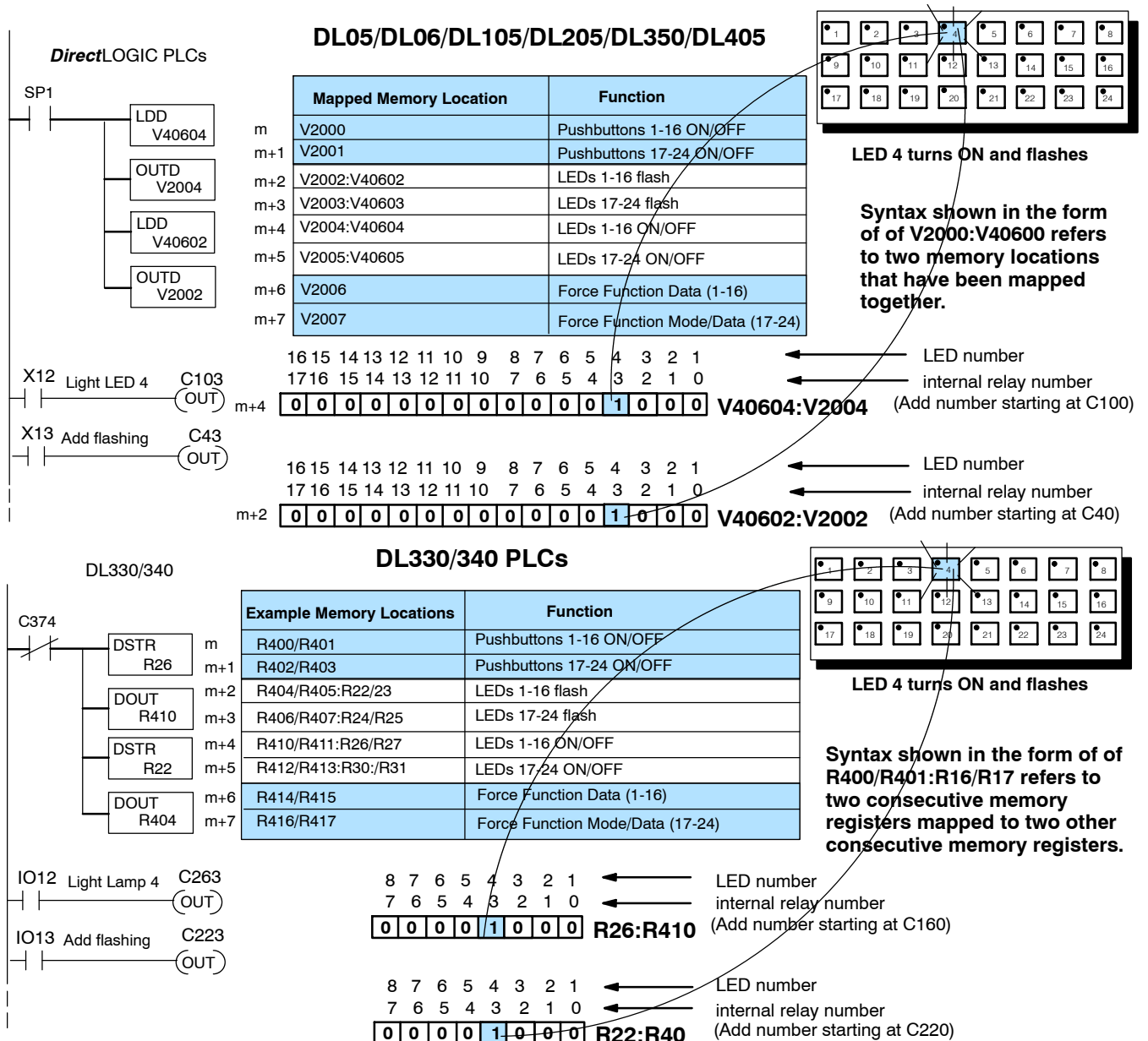

**Force Function Registers**



The OP-1224 has the ability to “force” a pushbutton ON or OFF with ladder logic. If this function is used, the force option must be enabled during configuration.

**NOTE:** The force function will only work for those pushbuttons that have been configured for “maintained” (alternate action). It will not work for momentary pushbuttons.

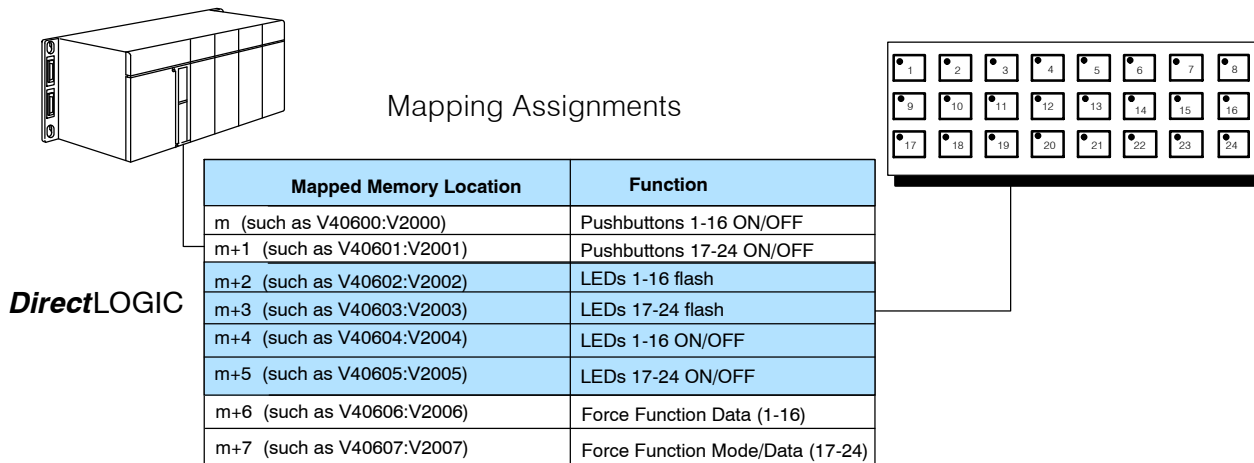

**How the Memory is Used-**Looking at the above memory map, **m+6** stores the forcing data for Pushbuttons 1-16 and **m+7** stores forcing data for Pushbuttons 17-24. There are three modes of the force function. These modes are controlled by the most significant bits of m+7.

**Mode 1 (M1)-** This forces all of the Pushbuttons to reflect the status stored in m+6 and m+7. For example, the data shown below would force Pushbuttons 3, 4 and 23 to ON and all the others would be forced OFF. Notice that bit 15 of m +7 is set to 1 for this mode. M2 and M3 are set to 0's.

**Mode 2 (M2)-** This forces ON only those Pushbuttons matching the bits set in registers m+6 and m+7. The bits not set do not affect the status of the Pushbuttons. You would set M2to 1 while M1 and M3 are set to 0.

**Mode 3 (M3)-** This forces OFF only those Pushbuttons matching the bits set in registers m+6 and m+7. The bits not set do not affect the status of the Pushbuttons. You would set M3 to 1 while M1 amd M2 are set to 0.

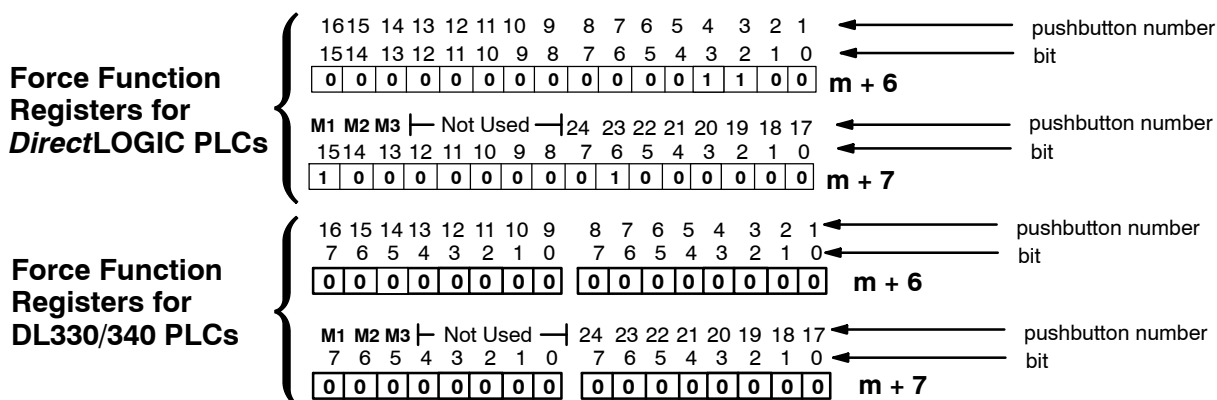

**Think of forcing as a one-shot process. That is, once the mode has been set in m+7, the bit patterns in m and m+1 are changed (according to the mode selected), then, all of the bits in m+6 and m+7 are set to zero. What this means is that all pushbuttons return to normal manual operation after the forcing is completed.**

**Forcing Pushbuttons ON or OFF**

In this example, Mode 3 of the force function is used to force Pushbutton 14 OFF when a process has been completed. Be sure to read Page 33 (if you haven't already done so) to learn the function of all three modes. For the **DirectLOGIC** PLC example, a base address of V40600 is used. And for the DL305, R16 is used in the example on the next page.

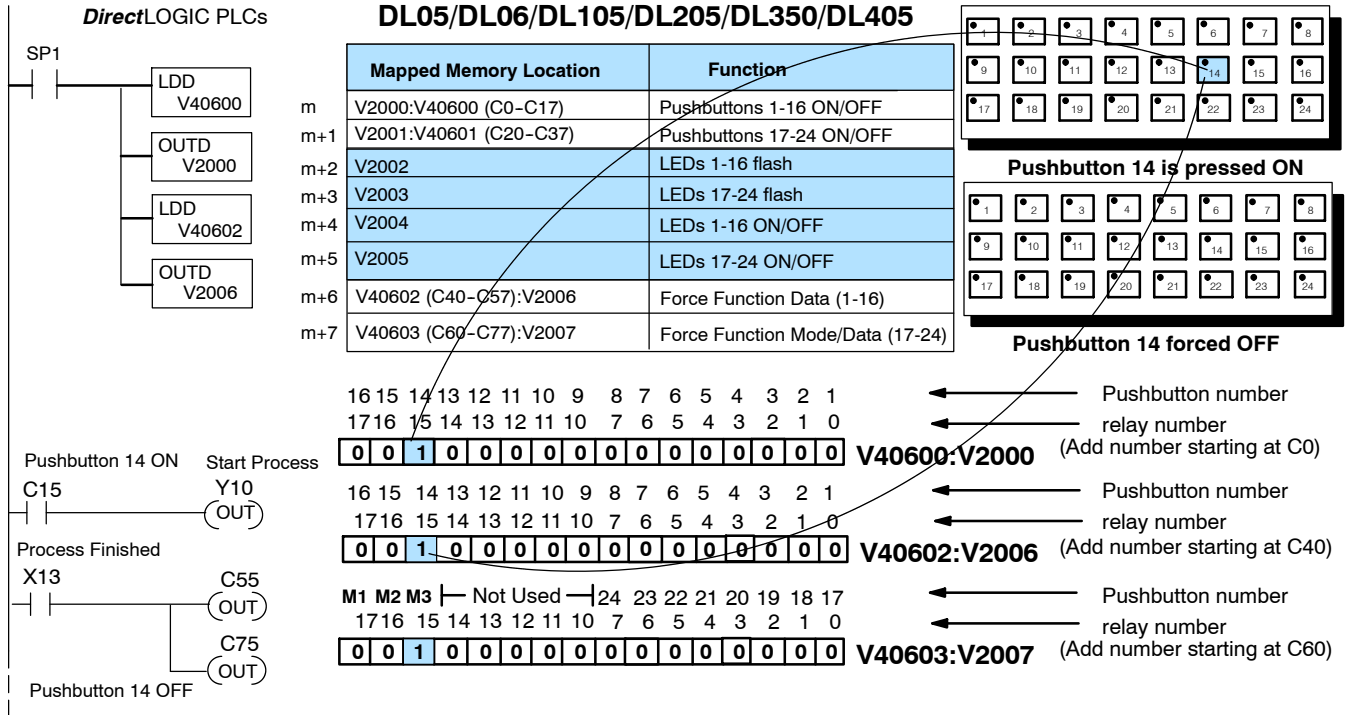

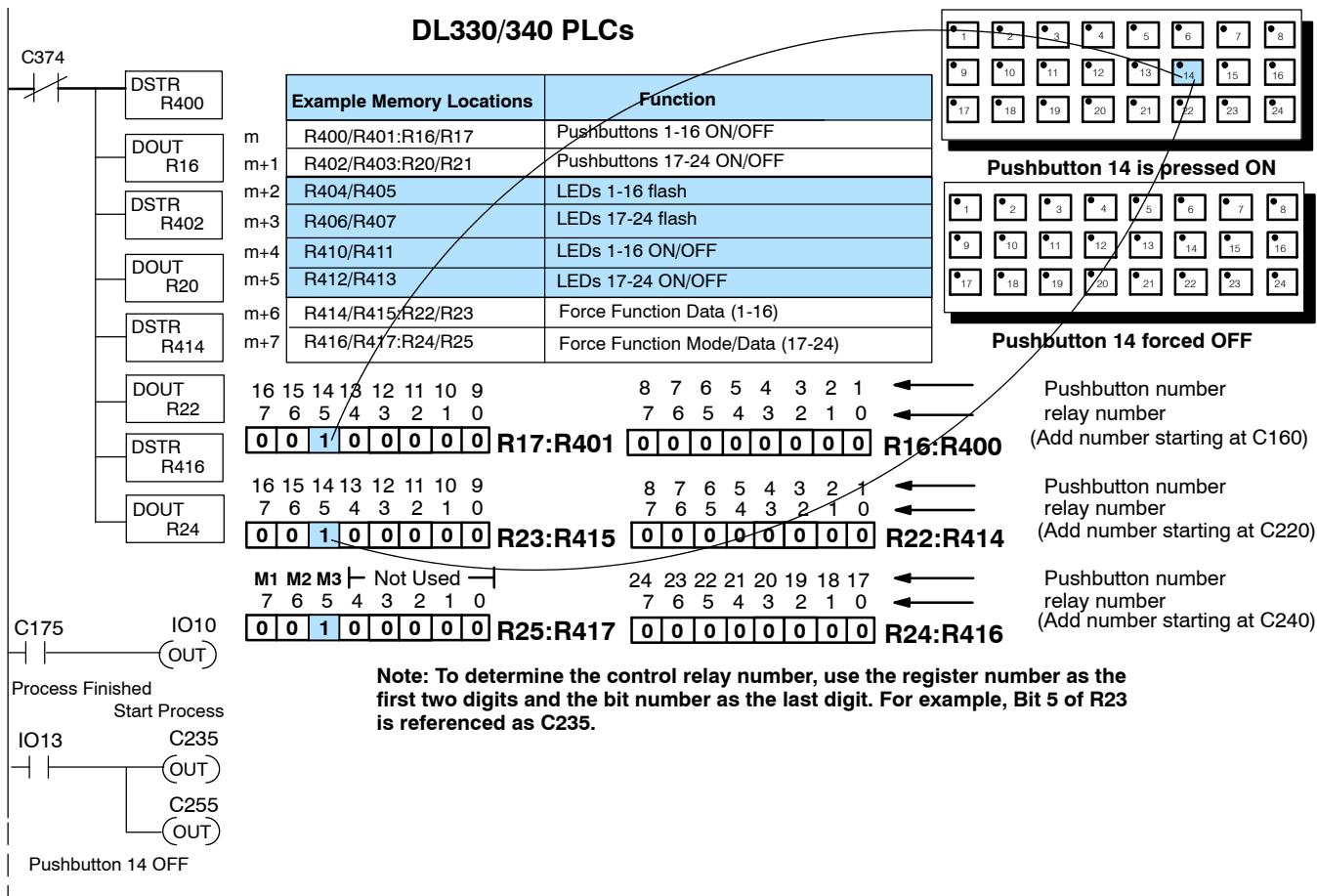

# Using the OP-1224 with an Allen-Bradley PLC

## Using the Pushbutton Status

As mentioned previously, integer type files can be mapped for the Allen-Bradley PLC when using it with the OP1224. In the example below, integer file registers have been mapped starting at base address N7:0. Pushbutton 3 is used to control Output 5 (O:3/5), and Pushbutton 4 is used to control Output 6 (O:3/6) and Pushbutton 23 is used to control Output 7 (O:3/7).

SLC 5/03 or 5/04

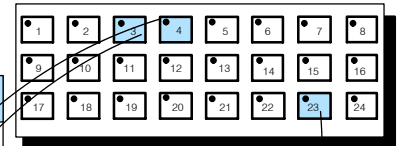

Mapped Memory Location	Function
m (such as N7: 0/0- 0/15)	Pushbuttons 1-16 ON/OFF
m+1 (such as N7: 1/0 1/15)	Pushbuttons 17-24 ON/OFF
m+2 (such as N7: 2/0 2/15)	LEDs 1-16 flash
m+3 (such as N7: 3/0 3/15)	LEDs 17-24 flash
m+4 (such as N7: 4/0 4/15)	LEDs 1-16 ON/OFF
m+5 (such as N7: 5/0 5/15)	LEDs 17-24 ON/OFF
m+6 (such as N7: 6/0 6/15)	Force Function Data (1-16)
m+7 (such as N7: 7/0 7/15)	Force Function Mode/Data (17-24)

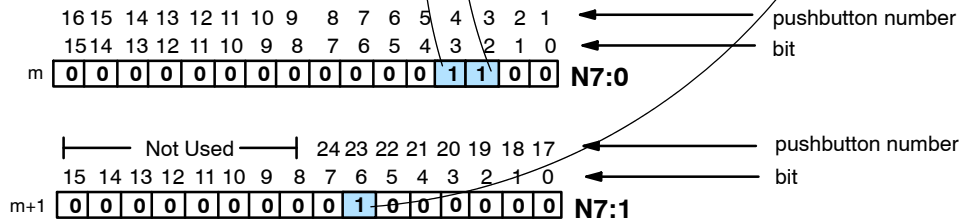
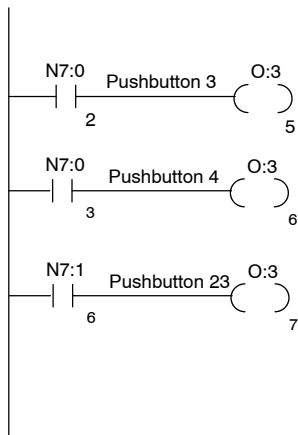

**Controlling LEDs Separately**

The LEDs can be controlled separately from the status of the pushbuttons. In the example below, Allen-Bradley input type files (I:0/2, I:0/3 and I:0/4) are being used to trigger the ON/OFF of LED3, LED4 and LED5.

**Remember: Any pushbutton configured for maintained (alternate action) will ignore the bits in these two words. Independent control of the LEDs can only be accomplished if LED Separation has been enabled during the initial configuration.**

**SLC 5/03 or 5/04**

Mapped Memory Location	Function
m (such as N7: 0/0– 0/15)	Pushbuttons 1-16 ON/OFF
m+1 (such as N7: 1/0 1/15)	Pushbuttons 17-24 ON/OFF
m+2 (such as N7: 2/0 2/15)	LEDs 1-16 flash
m+3 (such as N7: 3/0 3/15)	LEDs 17-24 flash
m+4 (such as N7: 4/0 4/15)	LEDs 1-16 ON/OFF
m+5 (such as N7: 5/0 5/15)	LEDs 17-24 ON/OFF
m+6 (such as N7: 6/0 6/15)	Force Function Data (1-16)
m+7 (such as N7: 7/0 7/15)	Force Function Mode/Data (17-24)

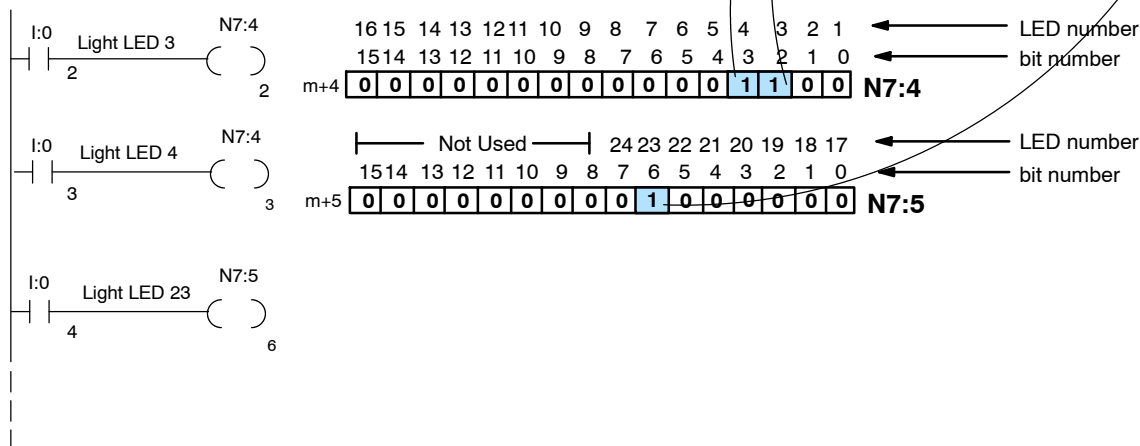
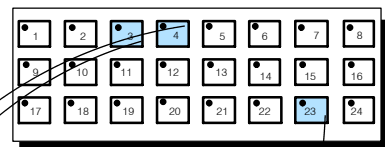

**Adding Flashing**

To draw extra attention to an LED that is lit, flashing can be added. If this feature is going to be used with one or more pushbuttons, there are three things which must always be remembered during panel configuration:

1. Flashing is only available for those buttons that have been configured as **Momentary**.
2. **LED Separation** must be enabled.
3. The **Flash Option** must be enabled.

The flashing option is triggered through ladder logic. The example on the previous page turned ON an LED. The example below adds flashing to an LED that has been turned ON. The flashing feature is controlled by the status of the bits in the **m+2** and **m+3** memory areas. The user memory in these locations have been mapped to internal relay memory. The example begins mapping at **N7:0** during the initial configuration. LED4 is turned ON then made to flash. Bit 3 of **m+4** turns the LED ON, and bit 3 of **m+2** makes it flash. In the example, input type files (I:0/3 and I:0/4). I:0/3 are used to turn ON LED 4 and I:0/4 turns ON the flashing feature for that particular LED.

**SLC 5/03 or 5/04**

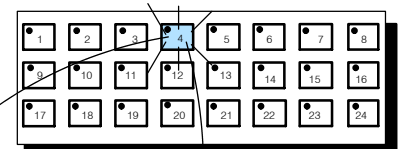

**LED 4 turns ON and flashes**

Mapped Memory Location	Function
m (such as N7: 0/0- 0/15)	Pushbuttons 1-16 ON/OFF
m+1 (such as N7: 1/0 1/15)	Pushbuttons 17-24 ON/OFF
m+2 (such as N7: 2/0 2/15)	LEDs 1-16 flash
m+3 (such as N7: 3/0 3/15)	LEDs 17-24 flash
m+4 (such as N7: 4/0 4/15)	LEDs 1-16 ON/OFF
m+5 (such as N7: 5/0 5/15)	LEDs 17-24 ON/OFF
m+6 (such as N7: 6/0 6/15)	Force Function Data (1-16)
m+7 (such as N7: 7/0 7/15)	Force Function Mode/Data (17-24)

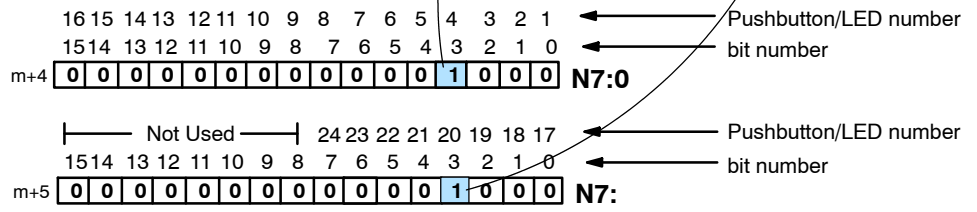
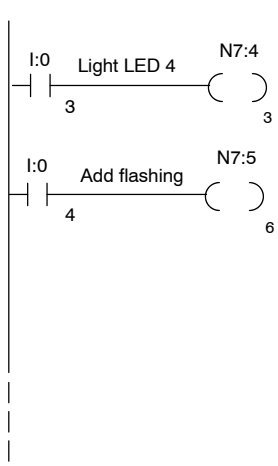

### Force Function Registers



The OP-1224 has the ability to “force” a pushbutton ON or OFF with ladder logic. If this function is going to be used, the force option must be enabled during configuration.

**NOTE:** The force function will only work for those pushbuttons that have been configured as “maintained” (alternate action). It will not work for momentary pushbuttons.

### Mapping Assignments

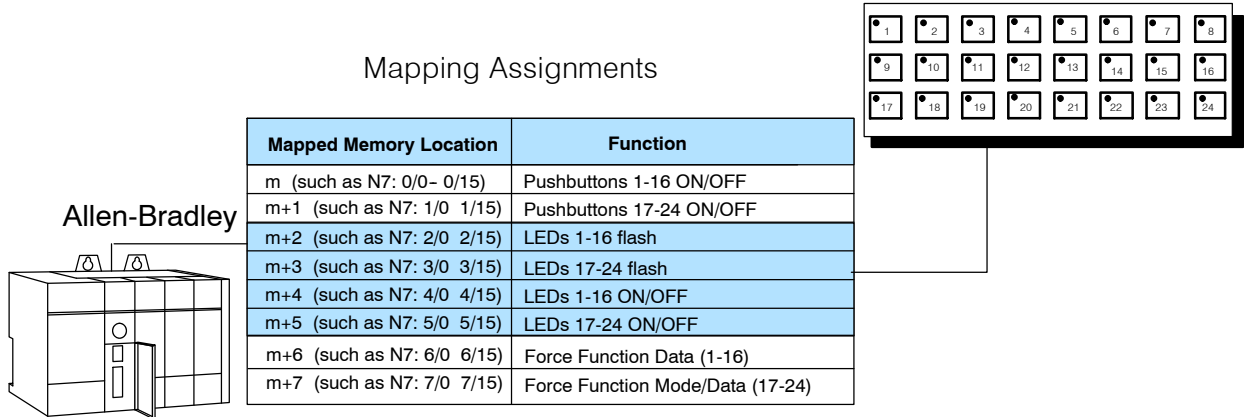

**How the Memory is Used**-Looking at the above memory map, **m+6** stores the forcing data for Pushbuttons 1-16 and **m+7** stores forcing data for Pushbuttons 17-24. There are three modes of the force function. These modes are controlled by the most significant bits of m+7.

**Mode 1 (M1)**- This forces all of the Pushbuttons to reflect the status stored in m+6 and m+7. For example, the data shown below would force Pushbuttons 3, 4 and 23 to ON and all the others would be forced OFF. Notice that bit 15 of m +7 is set to 1 for this mode. M2 and M3 are set to 0's.

**Mode 2 (M2)**- This forces ON only those Pushbuttons matching the bits set in registers m+6 and m+7. The bits not set do not affect the status of the Pushbuttons. You would set M2 to 1 while M1 and M3 are set to 0.

**Mode 3 (M3)**- This forces OFF only those Pushbuttons matching the bits set in registers m+6 and m+7. The bits not set do not affect the status of the Pushbuttons. M3 is set to 1 while M1 and M2 are set to 0.

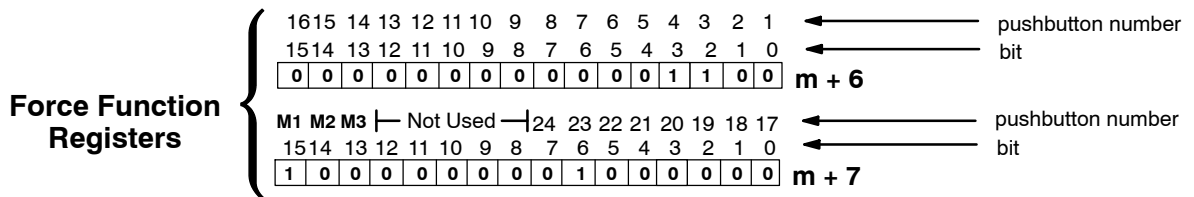

Think of forcing as a one-shot process. That is, once the mode has been set in m+7, the bit patterns in m and m+1 are changed (according to the mode selected) then, all of the bits in m+6 and m+7 are set to zero. What this means is that all pushbuttons return to normal operation after the forcing is completed.



**Forcing Pushbuttons ON or OFF**

Allen-Bradley integer file types can also be used to force pushbuttons ON or OFF. N7:0 has been chosen as the base address for the mapping in the PLC. In this example, Pushbutton 14 is used to start a process then forces the pushbutton OFF when the process is completed. N7:0 holds the bit that reflects the status of Pushbutton 14. N7:6 and part of N7:7 hold the data that the force feature uses when executing one of the three selectable modes (M1, M2 or M3). These modes are selectable in the upper three bits of the mapped memory area m+7. In the example, below the mode is embedded in N7:7.

Mode 3 is used in the following example. Mode 3 looks at N7:6, and whichever bits are set to 1, the corresponding pushbuttons are forced OFF. Since the 13th bit of N7:7 (corresponding to LED14) is set, the OP-1224 will force LED14 OFF.

**SLC 5/03 or 5/04**

Mapped Memory Location	Function
m (such as N7: 0/0- 0/15)	Pushbuttons 1-16 ON/OFF
m+1 (such as N7: 1/0 1/15)	Pushbuttons 17-24 ON/OFF
m+2 (such as N7: 2/0 2/15)	LEDs 1-16 flash
m+3 (such as N7: 3/0 3/15)	LEDs 17-24 flash
m+4 (such as N7: 4/0 4/15)	LEDs 1-16 ON/OFF
m+5 (such as N7: 5/0 5/15)	LEDs 17-24 ON/OFF
m+6 (such as N7: 6/0 6/15)	Force Function Data (1-16)
m+7 (such as N7: 7/0 7/15)	Force Function Mode/Data (17-24)

