

LED Work Light PATLED⁺ INSTRUCTION MANUAL [Model : CLK-24AG]

Thank you for purchasing the PATLEDs LED Light Bar for your application. Prior to installation, please read through this manual for proper installation and precautionary steps. In addition, please store this manual for future reference when performing maintenance, repairs or inspections. If you have any questions regarding this product, please contact our PATLITE Sales Representative.

Safety Precautions

In order to prevent any damage to the user and other personnel or to assets, note the following:

◆ The following symbols classifies the following precautions into two categories and explains the level of harm inflicted when caution is disregarded while using this product.

WARNING Displays the warning "Failure to follow warning may lead to death or severe injury".

CAUTION Displays the warning "Failure to follow caution may lead from light to medium injury or may lead to property loss or injury to others".

◆ The following symbols indicate and explains the nature of the information to be observed.

Prohibited This symbol indicates "Prohibited", which should not be carried out by all means.

Enforced This symbol indicates "Enforced", which should be observed and carried out by all means.

1. For safe application, observe the following:

WARNING [Prohibited]

- Do not disassemble or modify this product. Failure to comply may result in electric shock or fire.

Enforced

- Request the installation and wiring to be accompanied by a professional contractor. Failure to comply may result in electric shock, fire, or falling from high places.
- When this product is used for security purposes, it should be inspected daily, and to be used in conjunction with other security products, in case a malfunction should occur.

CAUTION [Prohibited]

- In order to avoid danger to the eyes, do not stare into the beam, do not view directly into the optical instrument, and don't turn the beam towards someone's eyes. The LED beam is hazardous to the eyes.
- Do not loosen any body screws. It will have an adverse effect on the protection rating.

Enforced

- Verify that the specified operating voltage is not exceeded.
- Avoid installation in the following locations:
 - Near space heaters or places where high temperatures are present.
 - In locations where chemical or explosive gasses, etc., are present.

2. Model Number Configuration

2-1. Model Number Configuration

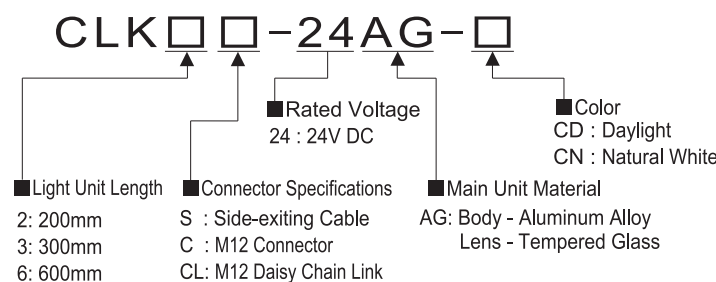

2-2. Model List

SGType	Cable	Bracket
CLK2S-24AG-CD	500mm	1
CLK3S-24AG-CD	500mm	1
CLK3C-24AG-CD	-	-
CLK3CL-24AG-CD	-	-
CLK6S-24AG-CD	500mm	2
CLK6C-24AG-CD	-	-
CLK6CL-24AG-CD	-	-

● The following is indicated below for the model prefixes

Side-exiting Cable: □S	Body - Aluminum Alloy Lens-Tempered Glass: AG
M12 Connector: □C	
M12 Daisy Chain Link: □CL	

2-3. Enclosure

CLK □S-24AG-□	Body(Cable with Cable Gland), Standard Bracket, Hex Socket Bolt, User's Manual
CLK □S-24AG-□	Body (with M12 Plug), Standard Bracket, Hex Socket Bolt, User's Manual
CLK □CL-24AG-□	Body (with M12 Plug and Socket), Standard Bracket, Hex Socket Bolt, User's Manual

※ A cable is not attached to models □C and □CL. Refer to [6. Option Parts] for their applications.
※ For the 600 mm length models, two sets of Standard Brackets with Hex Socket Bolts are included.

3. Part Names and Dimensions

3-1. Part Names and Dimensions

(Unit : mm)

◆ □S (Side-exiting Cable) Series
→ Cable wire type. This cannot be connected as depicted in section "4-4. Figure 8. CL Series Wiring Example."

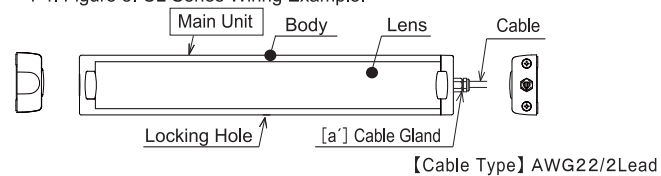

◆ □C (M12 Connector) Series
→ Power supply can be connected in the M12 connector. When an application requires linking, it is necessary to connect a link terminal connection. Refer to 4-4. Figure 8. "CL Series Wiring Example."

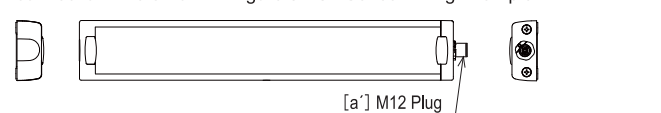

◆ □CL (M12 Daisy Chain Link) Series
→ It is used to connect between other units by linking them. Use it in conjunction with the C Series. Refer to 4-4. Figure 8. "CL Series Wiring Example."

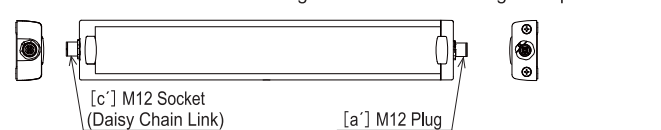

◆ Common Backplate Parts

CAUTION [Prohibited]

- Do not loosen or remove the Bracket Hook. Failure to comply will result in a decrease in waterproofing performance.

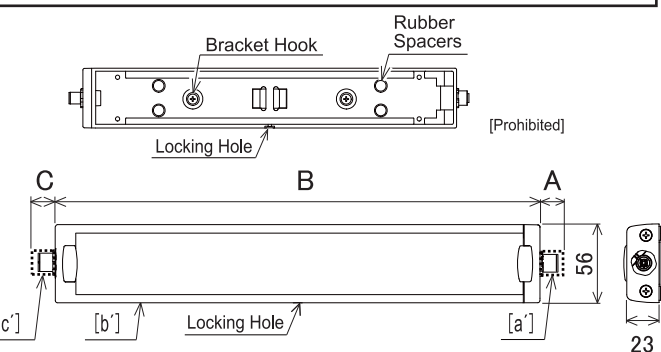
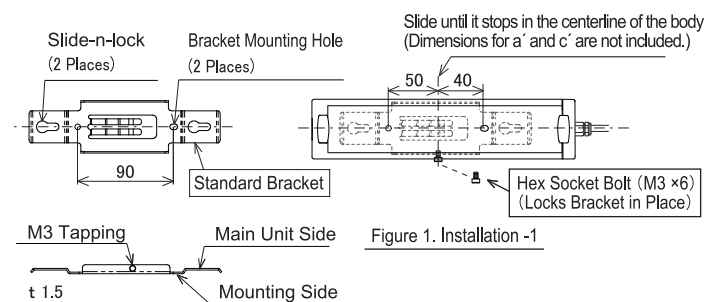

Table1. Dimensions

Model	DimensionC	DimensionB	DimensionA
	c'	b'	a'
CLK2S-24AG-□	-	250	(15)
CLK3S-24AG-□	-	350	(15)
CLK3C-24AG-□	-	350	(13)
CLK3CL-24AG-□	(12)	350	(13)
CLK6S-24AG-□	-	650	(15)
CLK6C-24AG-□	-	650	(13)
CLK6CL-24AG-□	(12)	650	(13)

◆ Standard Bracket (All Models)

● Specifications for the lens lengths of 200 mm and some 300mm include one Standard Bracket per unit, and for the 600mm lengths, two Standard Bracket sets are included. [Refer to 「4-3. Mounting Method」]



4. Installation

4-1. Installation Location

● Suitable for wet or damp locations.

WARNING [Prohibited]

- After installing this product, be careful not to use this product to climb onto a machine, or to get anything snagged onto this product while it is mounted on equipment, etc. Failure to comply may result in falling off the machinery or product damage may occur.

Enforced

- To prevent from electrocution, disconnect power prior to mounting or performing maintenance.
- Verify the installation location is a firm location which can handle the weight of the product and has no adverse vibrations. If installed in a place where vibration is frequent and/or exceeds the specifications, damage to the product may occur.
- The designated screws should be used for installation. Any parts used that are not specified may result in product damage or personal injury.

CAUTION [Enforced]

- Ensure this product is securely mounted, to prevent from falling, etc.
- This product is for indoor use only. (Not for outdoor use)
- Use protection to secure the standard bracket when mounting in a vertical direction.

4-2. Mounting Direction - All Models

● All Models; The attachment direction common to all the models is shown.
● Beware of the following:
1. To prevent liquid to accumulate, install with the "Locking Hole" in the downward direction, when level.
2. Mount the Standard Bracket in the direction indicated in the following figures to prevention from falling. (When Vertical)

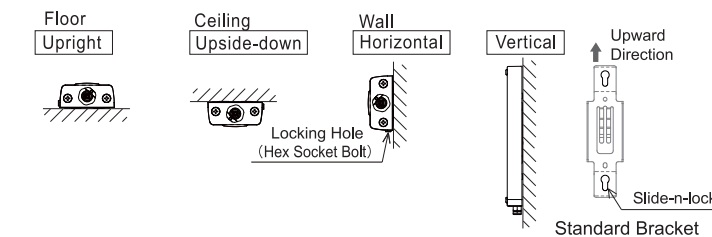

4-3. Mounting Method

● Specifications for the lens lengths of 200 mm and some 300mm include one Standard Bracket per unit, and for the 600mm lengths, two Standard Bracket sets are included. Moreover, when sliding the Main Unit onto the Standard Bracket, allow a clearance of at least 12mm on both ends to allow attachment and removal. Refer to Figure 4. "Slide Installation -1" and Figure 7. "Slide Installation -2."
● When connecting several units for the CL (M12 Daisy Chain Link) Series, be sure to connect the maximum number of links. Refer to "4-4. CL (M12 Daisy Chain Link) Series Cautionary Notes" to verify the number of links to use.

■ Lens Length: 200mm and 300mm (One Standard Bracket per unit included)

① Mounting Hole Dimensions and Standard Bracket Mounting (Recommended)
Ensure the Standard Bracket is attached to a flat and sturdy surface before making any holes for installation. M5 screw is bolted in the sequence of 1 then 2 (longer hole, first) as shown in the figure below, when the Standard Bracket is fixed into place. The recommended torque for the M5 screw is 2.8 N·m. More importantly, the body cannot be attached if the screw head is larger than 4 mm.

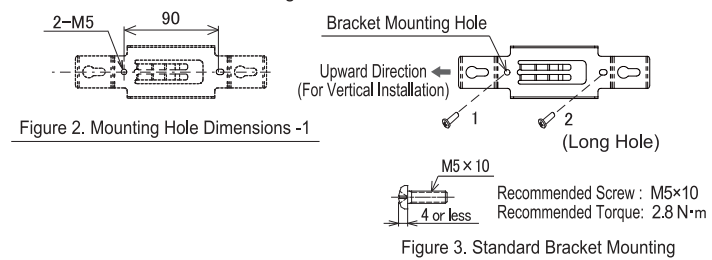

Figure 2. Mounting Hole Dimensions -1

② Main Unit Installation
After attaching the Standard Bracket, the Main Unit is attached. Insert the "Bracket Hook" in the back of the Main Unit and insert it into the "Slide-n-lock" holes of the bracket, then slide the Main Unit until the "Locking Hole" of the Main Unit is aligned with the "M3 tapping" for the Standard Bracket.

CAUTION [Prohibited]

- Do not loosen or remove the Bracket Hook. Failure to comply will result in a decrease in waterproofing performance.

Figure 4. Slide Installation -1

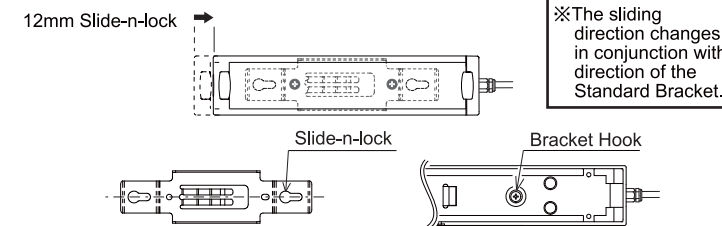

③ Hex Socket Bolt Lock-down
Use the "M3 tapping" Hex Socket Bolt to lock the Standard Bracket into place. This prevents the Body from unattaching from the Standard Bracket. Tighten with a torque of about 0.6N·m.

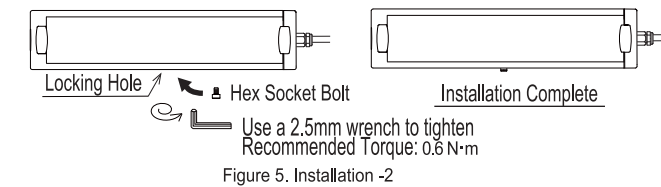

Figure 5. Installation -2

■ Lens Length: 600mm (Two Standard Brackets per unit included)

① Ensure the Standard Bracket is attached to a flat and sturdy surface before making any holes for installation. Using an M5 screw, refer to "Figure 6. Mounting Hole Dimensions -2" and "Figure 3. Standard Bracket Mounting" to mount in place. Tighten the M5 screw with a torque of about 2.8 N·m.
② After attaching the Standard Bracket, the Body is attached. Insert the "Bracket Hook" in the back of the Main Unit and insert it into the "Slide-n-lock" holes of the bracket, then slide the Main Unit until the "Locking Hole" of the Main Unit is aligned with the "M3 tapping" for the Standard Bracket.
③ Use the "M3 tapping" Hex Socket Bolt to lock the Standard Bracket into place. This prevents the Body from unattaching from the Standard Bracket. Tighten with a torque of about 0.6 N·m.

① Mounting Hole Dimensions and Standard Bracket Mounting (Recommended)

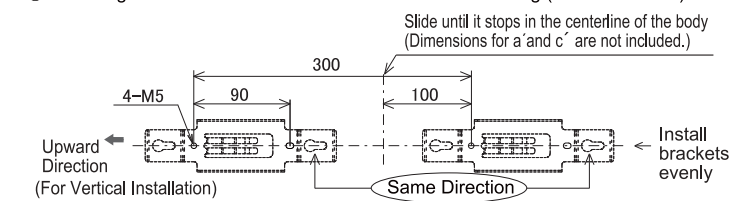

Figure 6. Mounting Hole Dimensions -2

② 600mm Main Unit Installation and Hex Socket Bolt Lock-down

※ The sliding direction changes in conjunction with direction of the Standard Bracket.

CAUTION [Prohibited]

- Do not loosen or remove the Bracket Hook. Failure to comply will result in a decrease in waterproofing performance.

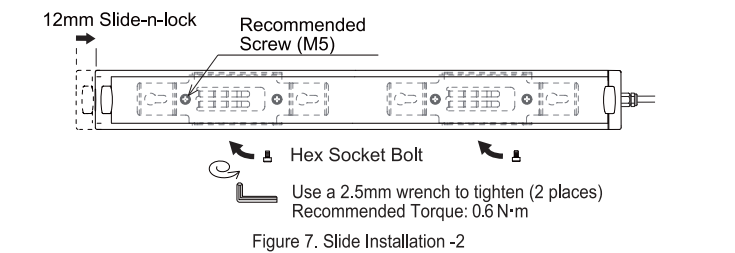

Figure 7. Slide Installation -2

4-4. CL (M12 Daisy Chain Link) Series Cautionary Notes

CAUTION [Enforced]

- When linking together, there is a restriction on the maximum number of links. Be sure to use it within the maximum number of links. Refer to "Table 2. Maximum Links." Exceeding the number of maximum links can cause failure.
- Linking this product requires "C (M12 Connector) Series" as the terminal link.

● When installing with option parts "M12 link-cable 4-wire 0.6m" side-by-side, a gap between the ends of the Body requires a distance from 150mm to 600mm. Refer to "Figure 8. CL Series Wiring Example."

● To the customer; be sure the cable is installed with the distance between products set by the corresponding cable.

※ Refer to "5-1. Wiring" for the Daisy Chain Link connection wiring example for the "CL Series."

Table 2. Maximum Links

Combinations	Terminal Links per unit		Daisy Chain Links per unit		Maximum Connections per unit
	3C	6C	3CL	6CL	
i	1	-	1-4	-	5
ii	1	-	1-2	0-1	4
iii	1	-	-	1-2	3
iv	-	1	1-3	-	4
v	-	1	0-1	1	3

※ Refer to "Table 2. Maximum Links" for the maximum number of links. Be sure to use maximum number of links as depicted in "Figure 8. CL Series Wiring Example" below. Exceeding the number of maximum links can cause failure.

Figure 8. □CL Series Wiring Example

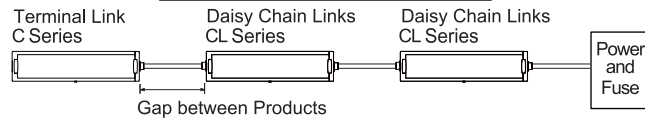

※ When installing with option parts "M12 link-cable 4-wire 0.6m" side-by-side, a gap between the ends of the body requires a distance from 150mm to 600mm.

5. Wiring and Proper Use

WARNING

- Be sure to disconnect the power when wiring, mounting, exchanging, or repairing the product. Failure to comply may result in damage of the internal circuitry and the danger of electric shock due to short-circuiting.

CAUTION

- Check that the proper voltage is connected before applying power.
- Do not pull on the cable, or try to push it inside the unit. Possible cause of failure may occur. In addition, allow a margin of slack for the wire and cable to prevent stress.
- Use a constant-voltage regulated power supply. Possible cause of failure may occur with the use of a constant current power supply.
- Install a fuse to protect it from the power supply. The product can be protected by short-circuiting due to mis-wiring and overcurrents or overvoltages which can damage it.

● The suitability of the luminaire supply connections shall be determined in the end use product. (C and CL Series)

5-1. Wiring

- Use a UL authenticated Class 2 power supply unit to connect power to this product. The power supply unit is constant voltage type.
- This product contains a 2A (slow-blow) fuse inside. Use an external fuse rated for the machine, which is connected to the product, to protect the machine from damage.

□S (Side-exiting Cable) Series Wiring Example

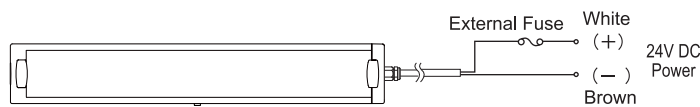

CAUTION

- The protection rating for the side exiting wire (2S, 3S, 6S) does not include the cable ends. If the ends of the cable are in contact with water or exposed to dew or condensation, refer to the indications below to dress the cable ends for water and oil resistance.
 - Connect the wire ends in a location which will not expose the ends to water or oil.
 - Use Fillers, such as silicon, etc., to seal the cable ends. Refer to the circled part of the figure below for the sections requiring protection from water and/or oil intrusion.

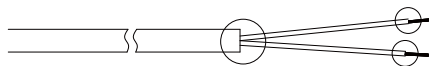

C (M12 Connector) Series Wiring Example

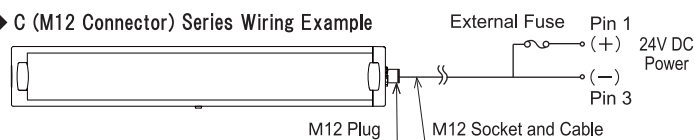

※ When using the optional M12 socket cable "4-wire M12 socket cable-5m", the power connections are: Brown (+) / Blue (-).

CL (M12 Daisy Chain Link) Series Wiring Example

- The link terminal for the product should use the □C (M12 Connector) Series.

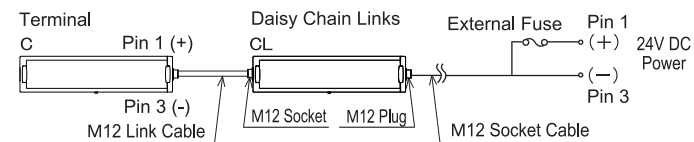

※ When using the optional M12 socket cable "4-wire M12 socket cable-5m", the power connections are: Brown (Positive) / Blue (Negative).

Link Connection Current Rating

- Calculate the total current by adding the current rating for each link connected. Refer to the rated current consumption in "8. Specification." Be sure to use maximum number of links as calculated in the figure below. Refer to "Table 2. Maximum Links" for 4-4. CL (M12 Daisy Chain Link) Series connections.

<Example> Refer to the data for "Combination ii" in "Table 2. Maximum Link" to look up the current ratings for the following models.

Terminal Links: 3C×1 Unit; Daisy Chain Links: 3CL×1 Unit + 6CL×1 Unit = 2088mA

Terminal Link	Daisy Chain Links		Daisy Chain Link Current Consumption
3C×1 unit 522mA×1 unit	+ 3CL×1 unit 522mA×1 unit	+ 6CL×1 unit 1044mA×1 unit	2088mA

※ When using the Optional Cable, a voltage drop will cause the Daisy Chain Link Current Consumption to decrease.

M12 Connector

C (M12 Connector) Series and CL (M12 Daisy Chain Link) Series Wiring

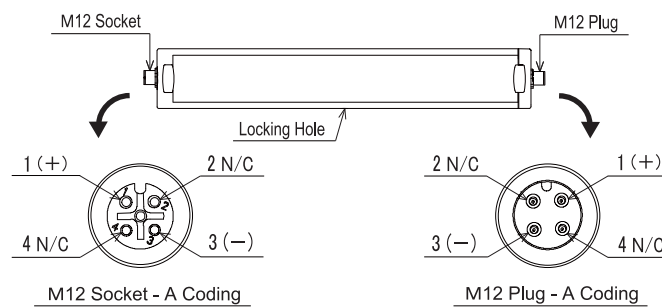

※ The C (M12 Connector) Series does not include an M12 Socket part.

5-2. Operation

- Referring to section "5-1. Wiring" above, by applying 24V DC, the LED will turn on.
 - LED's will start to light-up when 0.1mA or more is applied.

6. Option Parts

- This product offers option parts. Visit our homepage for more details.

All Models

Application: M12 Plug Side connects to power supply.
"4-wire M12 Socket Cable, 5m length"; Number: 1536308
Manufacturer: Phoenix Contact Corp.
Part Number: SAC-4P-5,0-PUR/FS SCO

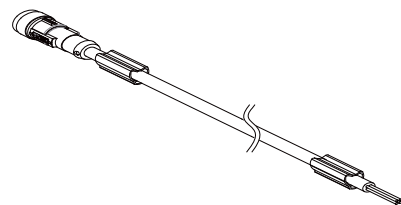

All Models

Application: Daisy Chain Link Connections.
"4-wire M12 Link Cable, 0.6m length"; Number: 1518892
Manufacturer: Phoenix Contact Corp.
Part Number: SAC-4P-MS/0,6-PUR/FS SCO

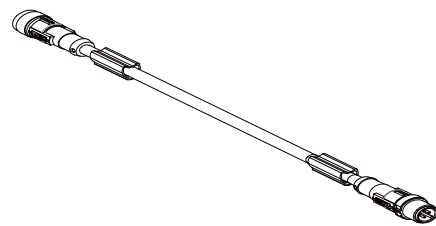

7. Maintenance and Inspection

If the product does not work after referring to the table below, please request for repair. In addition, if there are any questions concerning this product, feel free to contact your PATLITE Sales Representative.

Problem	Where to Check	What to Do
Does not light up	Is the power properly supplied?	Verify the voltage has been connected.
		Verify the proper polarity.
		Verify the proper voltage is supplied. (24V DC)
		Verify the external fuse has not been burned-out.

8. Specifications

Model	CLK2S -24AG	CLK3□ -24AG	CLK6□ -24AG
Color Code	CD	CD	CN
Luminous Color	Daylight	Daylight	Natural White
Color Temperature (typ.)	6500 K	6500 K	5000 K
Illuminance (typ.)	1200 lx	1050 lx	2100 lx
(Center, at DC24V)	300 lx	260 lx	580 lx
Total Luminous Flux	1300 lm		2600 lm
Rated Voltage	24V DC (Polarized)		
Operating Voltage Range	24V DC ±10%		
Rated Current Consumption ^{※1}	348mA ±10%	522mA ±10%	1044mA ±10%
Rated Power Consumption	8.4W	12.5W	25.0W
Operating Ambient Temperature	-40°C - +60°C		
Operating Ambient Humidity	90% RH or less, no condensation		
Main Unit Material	Body: Aluminum Alloy Lens: Tempered Glass		
Mounting Location	Indoor		
Mounting Direction	All Directions		
Protection Rating ^{※2}	IP66G/ 67G (JIS C0920)/ 69K (DIN 40050 part 9) (Cable Connector not included)		
Insulation Resistance	500V DC 5MΩ or more		
Withstand Voltage	500VAC for 1 minute (between terminals and chassis)		
Vibration Resistance	30Hz 19.6m/s ²		
Mass (Tolerance ±10%)	450g	600g	1070g
Standard Bracket Mass (±10%)	76g		76g x 2pcs

※1 When using the Optional Cable, a voltage drop will cause the Daisy Chain Link Current Consumption to decrease.

※2 Using the Optional Cables.

- This product conforms to EN standard and shows the CE Marking. This product has been tested and found to comply with the limits for a Class A device, pursuant to EMC DIRECTIVE. These limits are designed to provide reasonable protection against harmful interference when the equipment is operated in a commercial environment. This product must not be used in residential areas.

Note

It has passed the oil resistant test from the following common cutting oils. The following oil was diluted by 20 times and the adhesive used for the product was immersed at 55°C for 240 hours (10 days).

Company Name (Manufacturer)	Oil Name
Hangsterfer's Laboratories Inc.	Hangsterfer's S-500
Yushiro Chemical Industry Co., Ltd.	Yushiroken Synthetic #663
Castrol	Syntilo 9954
Blaser Swisslube Inc.	Blasocut BC35LFSW

Confirmation in result of swelling, contraction, dissolution, exfoliation, separation, cracks, and discoloration by the accelerated impregnation examination with the above-mentioned oil type for diluted oil at 55°C for 240 hours (ten days) was made.

Due to the additive agents in oil, the application of oils other than the ones mentioned above may influence physical properties, therefore, please investigate before purchasing.

* The mentioned company names, product names, trademarks, etc. are the registered trademarks or trademarks in Japan for each company, and/or other countries.

CAUTION

- Specifications and dimensions may change without prior notice for improvements, etc.
- Due to the characteristics of the LED, color temperature, brightness and hue will differ for every LED and every product.
- Since all IP examinations are done according to specified conditions and regulated time, the protection rating is not guaranteed for an extended period of time.

PATLITE Corporation

G2G

PATLITE Corporation ※Head office <http://www.patlite.com/>
4-1-3, Kyutaromachi, Chuo-ku, Osaka 541-0056 Japan

PATLITE (U.S.A.) Corporation <http://www.patlite.com/>
PATLITE Europe GmbH ※Germany <http://www.patlite.eu/>
PATLITE (SINGAPORE) PTE LTD <http://www.patlite.com/>
PATLITE (CHINA) Corporation <http://www.patlite.cn/>
PATLITE KOREA CO., LTD. <http://www.patlite.co.kr/>
PATLITE TAIWAN CO., LTD. <http://www.patlite.tw/>
PATLITE (THAILAND) CO., LTD. <http://www.patlite.co.th/>

PATLITE, the PATLITE logo and PATLED'S logo are trademarks, or registered trademarks of the PATLITE Corporation of Japan and each country.

L95100058 | F
'17.01 AUTO