

# USER MANUAL



*DPM2 Series*



*DPM2L Series*

## PROSENSE DPM2 SERIES DIGITAL PANEL METER FOR PROCESS, TEMPERATURE AND RESISTANCE INPUT SIGNALS

**Models:**  
**DPM2-AT-HL, DPM2-AT-2R-HL**  
**DPM2L-AT-HL, DPM2L-AT-2R-HL**

*Scan or click the QR code for a series of Configuration and Programming videos for the ProSense DPM Series Panel Meters*



## In this Chapter...

<b>General Information</b> .....	4
Package Contents.....	4
Recycling Instructions.....	4
General Safety Considerations.....	4
Symbols Identification.....	4
Maintenance.....	5
Technical Support.....	5
Agency Approvals.....	5
<b>Description</b> .....	5
Features.....	6
<b>Dimensions and Mounting</b> .....	6
Installation.....	7
<b>Wiring Terminals</b> .....	7
<b>Wiring Examples</b> .....	9
Process Input Signal Wiring Diagrams (V).....	9
Process Input Signal Wiring Diagrams (mA).....	10
Potentiometer Input Wiring Diagram ( $\Omega$ ).....	10
Pt100 and Pt1000 Sensor Input Wiring Diagrams.....	11
Thermocouple J, K, T and N Input Wiring Diagram.....	11
Resistance Input Wiring Diagram ( $\Omega$ ).....	11
Relay Output Wiring.....	11
<b>Display and Key Pad</b> .....	12
<b>Configuration</b> .....	13
Input Configuration.....	13
Process.....	14
Temperature.....	14
Display Offset.....	14
Potentiometer.....	15
Resistance.....	15
<b>Display Configuration</b> .....	15
Display Scaling.....	16
Process Input.....	17

Temperature Input .....	18
Potentiometer Input.....	18
Resistance Input .....	19
<b>Relay Setpoint Configuration.....</b>	<b>20</b>
<b>Additional Functions.....</b>	<b>22</b>
MAX/MIN and RESET Functions .....	22
Direct Access to Setpoints Value .....	22
Return to Factory Configuration .....	23
<b>Configuration Lock-Out.....</b>	<b>23</b>
<b>Technical Specifications.....</b>	<b>26</b>
<b>Instrumentation Configuration Notes .....</b>	<b>28</b>

## General Information

### Package Contents

- DPM2 Series Process digital panel meter
- Quick start guide
- Mounting panel accessories (a sealing gasket and 2 fixing clips)
- Wiring accessories (plug-in terminal block connectors and 2 key tools for wire insertion)
- 4 adhesive engineering unit label sheets

### Recycling Instructions



This electronic instrument is covered by the 2002/96/CE European Directive so, it is properly marked with the crossed-out wheeled bin symbol that makes reference to the selective collection for electrical and electronic equipment which indicates that at the end of its lifetime, the final user cannot dispose of it as unsorted municipal waste.

In order to protect the environment and in agreement with the European legislation regarding waste of electrical and electronic equipment from products put on the market after August 13, 2005, the user can give it back, without any cost, to the place where it was acquired to proceed to its controlled treatment and recycling.

### General Safety Considerations

All instructions and guidelines for the installation and manipulation that are present in this manual must be considered to ensure personal safety and to prevent damage to either the instrument or any equipment connected to it.

Safety of any equipment incorporated to this instrument is the responsibility of the system installer.

If this electronic indicator is used in a manner not specified by the manufacturer in this manual, the protection provided by the instrument may be impaired.

### Symbols Identification



**Warning: Potential risk of danger.**

Read complete instructions when this symbol appears in order to know the potential risk and know how to avoid it.



**Warning: Risk of electric shock.**



**Instrument protected by double isolation or reinforced isolation.**

## Maintenance

To ensure instrument accuracy, it is recommended to check its performance according to the technical specifications listed in this manual.

For front cover cleaning, just wipe with a damp cloth and neutral soap product. **DO NOT USE SOLVENTS!**

## Technical Support

We strive to make our manuals the best in the industry. We rely on your feedback to let us know if we are reaching our goal. If you cannot find the solution to your particular application, or, if for any reason you need technical assistance, please call us at:

**1-800-633-0405**

Our technical support group will work with you to answer your questions. They are available Monday through Friday from 9:00 A.M. to 6:00 P.M. Eastern Time. We also encourage you to visit our web site where you can find technical and non-technical information about our products and our company.

**[www.AutomationDirect.com](http://www.AutomationDirect.com)**

## Agency Approvals



## Description

The ProSense DPM2 series offers a simple, low cost digital display of analog process signals, temperature in either Fahrenheit or Celsius from RTD or Thermocouple temperature sensors, or potentiometer inputs. The 4-digit 14mm character height red LED display is easily scaled into any engineering units from -9999 to 9999 with a selectable decimal point location. The DPM2L offers a larger 20mm character height scaled from -1999 to 9999. Two point direct or reverse acting linear scaling values can be entered manually or by introducing actual sensed process values in Teach mode. Temperature inputs are pre-configured for fixed temperature ranges based on the type of temperature sensor and can be displayed with 1 or 0.1 degree of resolution. One model includes two SPDT relay outputs that can be set to activate on an increasing or decreasing input signal with hysteresis or time delay operation. The meter is powered from an external wide range AC or DC power supply and provides 24VDC for external sensor excitation. The 1/8 DIN housing is easy to install in a panel and the meter face has an IP65 rating. Configuration parameters can be totally or selectively locked out to prevent unauthorized or accidental changes to the meter's operation. Additionally, the DPM2 meters include memory and reset of minimum and maximum display values. ProSense digital panel meters are backed by a 3 year warranty.

### Features

- 96 x 48mm 1/8 DIN
- Simple menu driven pushbutton configuration
- 14mm 4 digit (-9999 to 9999) or 20mm (-1999 to 9999) red LED display
- Selectable decimal point
- Process ( $\pm 10V$ ,  $\pm 200V$  and  $\pm 20mA$ )
- Temperature (RTD: Pt100, Pt1000, TC: J, K, T, N, Resolution:  $1^\circ F$ ,  $0.1^\circ F$ ,  $1^\circ C$ ,  $0.1^\circ C$ )
- Potentiometer ( $100\Omega$  to  $100k\Omega$ )
- Resistance ( $999.9\Omega$ ,  $9999\Omega$  and  $50k\Omega$ )
- AC or DC powered
- Sensor excitation voltage 24V
- Optional (2) Form C SPDT relays
  - N.O. or N.C. operation
  - Activation on increasing or decreasing input signal
  - Hysteresis or time delay operation
- Display scaling or process teaching modes
- Configuration for direct or reverse acting linear processes
- Minimum and maximum value memory
- Total or selective configuration lock out
- 3 year warranty

## Dimensions and Mounting

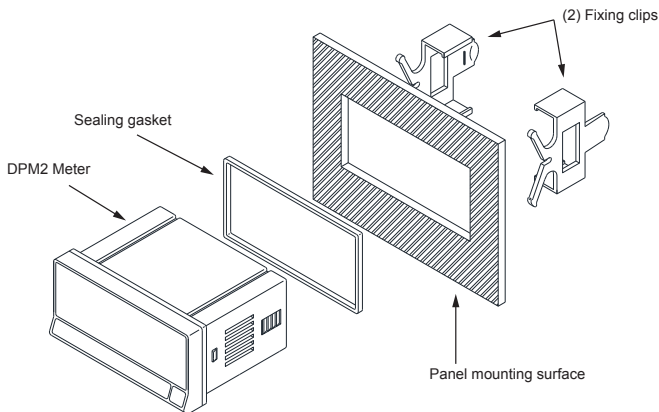

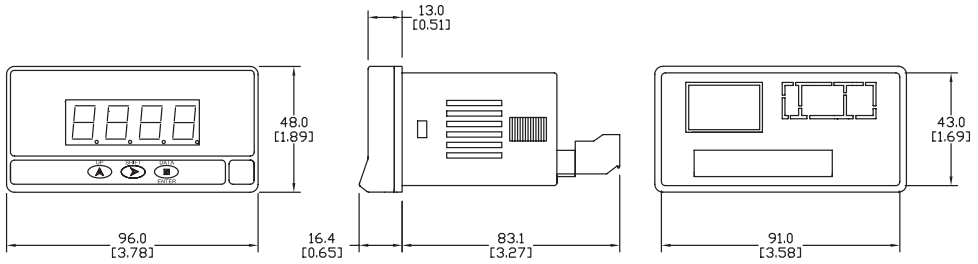

## Installation

To install the instrument, prepare a 92mm x 45mm panel cut-out and slide the unit inwards making sure to place the sealing gasket between the front side panel and the front bezel.

While holding the unit in place, put the fixing clips on both sides of the case and slide them through the guide tracks until they reach the panel at the rear side.

Press slightly to fasten the clips to the latching slots on the case and get the unit fully assembled and close fitted to achieve a good seal.

To remove the instrument from the panel, pull the rear fixing clips latching tabs outwards until they are disengaged, then slide the fixing clips back over the case.

Installation	
<b>Dimensions</b>	96 x 48 x 83.1mm (1/8 DIN)
<b>Panel Cutout</b>	92 x 45mm (Max. panel thickness 10mm)
<b>Case Material</b>	Polycarbonate UL 94 V-0

## Wiring Terminals

Output relay terminals  
(DPM2-AT-2R-HL only)

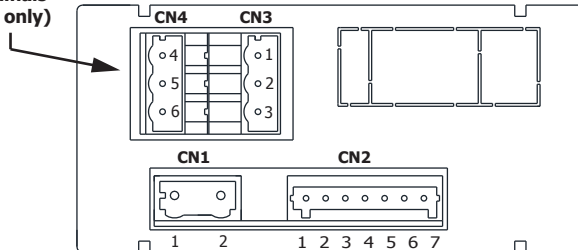

Terminals			
Connector	CN1	CN2	CN3 & CN4
Wire cross section	0.08 to 2.5mm <sup>2</sup> (28 to 12 AWG)	0.08 to 1.5mm <sup>2</sup> (28 to 14 AWG)	0.08 to 2.5mm <sup>2</sup> (28 to 12 AWG)
Strip length	8 to 9mm	6 to 7mm	8 to 9mm
Manufacturer	Wago 231-202/026-000	Wago 734-107	Wago 231-303/026-000
Cage clamp connection	Insertion tool or screwdriver with 0.5 mm x 3.0 mm blade	Insertion tool or screwdriver with 0.3 mm x 1.8 mm blade	Insertion tool or screwdriver with 0.5 mm x 3.0 mm blade

CN1	
AC Supply	DC Supply
1 Line	1 VDC
2 Neutral	2 VDC

*Polarity insensitive for DC power*

CN2	
1	Common / RTD B / -TC / Pot. Term. 1
2	RTD A / +TC / 10kΩ res. / Pot. center
3	50kΩ res. / Pot. Term. 2
4	RTD B Pt100
5	+20mA
6	Excitation +24V
7	+10/200VDC

CN4 (Relay 2)	
4	NO2
5	CM2
6	NC2

CN3 (Relay 1)	
1	NO1
2	CM1
3	NC1

## (DPM2-AT-2R-HL and DPM2L-AT-2R-HL only)

*NO: Normally open contact*

*CM: Common*

*NC: Normally closed contact*

## CN2 Terminals

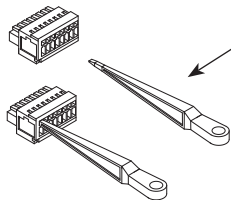

*Insertion Tool (included with meter)*

*Insert wires into the proper terminal while using the insertion tool to open the clip inside the connector. Release the insertion tool to fix wire to the terminal.*

## CN1, CN3, CN4 Terminals

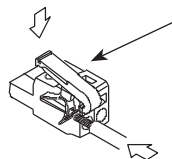

*Insertion Tool (included with meter)*

*Insert wires into the proper terminal while using the insertion tool to open the clip inside the connector. Release the insertion tool to fix wire to the terminal.*

### Warning Isolation:

1500Vrms for 1 minute to signal terminals (CN2) and power terminals (CN1).

2500Vrms for 1 minute to signal terminals (CN2) and relays terminals (CN3 or CN4).

2500Vrms for 1 minute to power terminals (CN1) and relays terminals (CN3 or CN4).

Refer to the instructions in this manual to preserve safety protections.



**WARNING: If this instrument is not installed and used in accordance with these instructions, the protection provided by it against hazards may be impaired.**

To meet the requirements of EN 61010-1 standard, where the unit is permanently connected to main supply, it is obligatory to install a circuit breaking device easily reachable by the operator and clearly marked as the disconnecting device.

To guarantee electromagnetic compatibility, the following guidelines should be kept in mind:

- Power supply wires should be separately routed from signal wires and never run in the same conduit.
- Use shielded cable for signal wiring.
- Cables section should be  $\geq 0.25 \text{ mm}^2$ .

Before connecting signal wires, signal type and input range should be verified to be within the right limits. Do not connect simultaneously more than one input signal to the meter.



# Wiring Examples

## Process Input Signal Wiring Diagrams (V)

4 WIRE CONNECTION WITH EXTERNAL EXCITATION

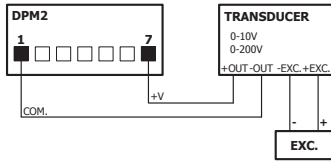

4 WIRE CONNECTION WITH EXCITATION SUPPLIED BY THE DPM2

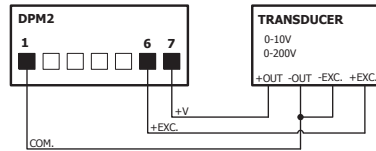

3 WIRE CONNECTION WITH EXTERNAL EXCITATION

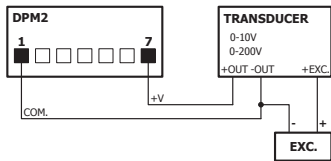

3 WIRE CONNECTION WITH EXCITATION SUPPLIED BY THE DPM2

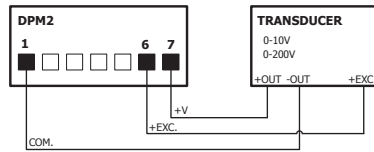

## Process Input Signal Wiring Diagrams (mA)

4 WIRE CONNECTION WITH EXTERNAL EXCITATION

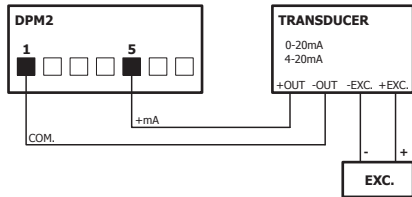

4 WIRE CONNECTION WITH EXCITATION SUPPLIED BY THE DPM2

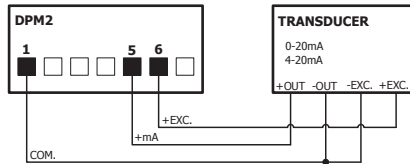

3 WIRE CONNECTION WITH EXTERNAL EXCITATION

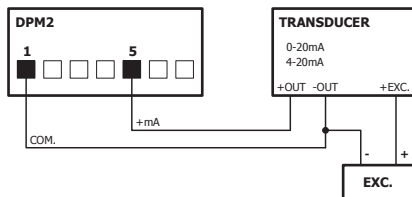

3 WIRE CONNECTION WITH EXCITATION SUPPLIED BY THE DPM2

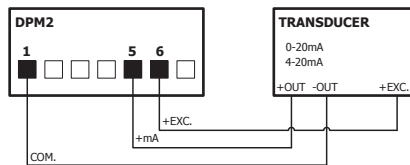

2 WIRE CONNECTION WITH EXTERNAL EXCITATION

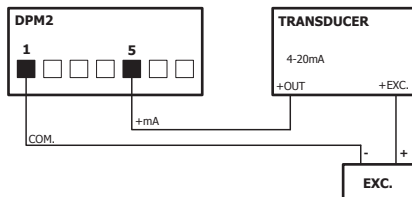

2 WIRE CONNECTION WITH EXCITATION SUPPLIED BY THE DPM2

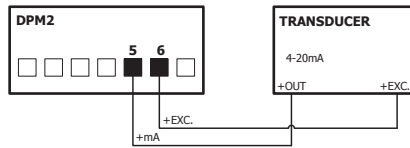

## Potentiometer Input Wiring Diagram ( $\Omega$ )

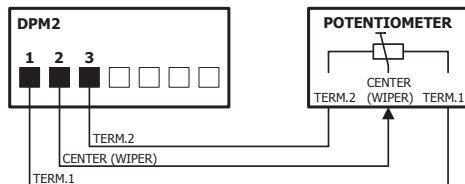

**NOTE:**

Do not perform measurements with potentiometer subjected to external voltage, since it may interfere in the measurement, alter the reading and even cause serious damages on this unit.

## Pt100 and Pt1000 Sensor Input Wiring Diagrams

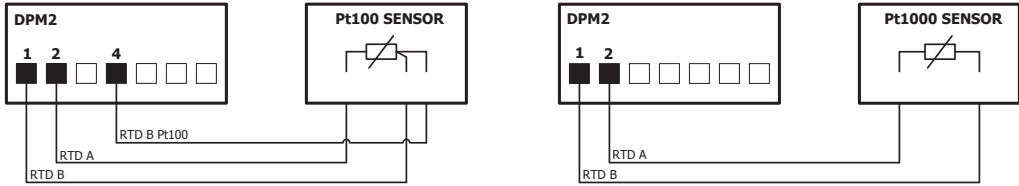

## Thermocouple J, K, T and N Input Wiring Diagram

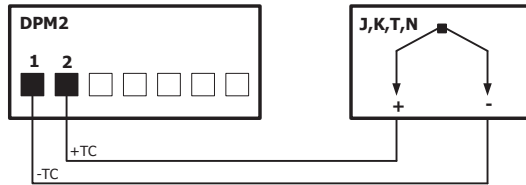

## Resistance Input Wiring Diagram ( $\Omega$ )

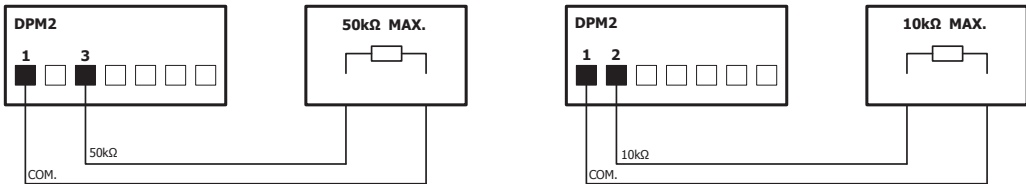

Note: Do not perform measurements with resistance subjected to external voltage, since it may interfere in the measurement, alter the reading and even cause serious damages to this unit.

## Relay Output Wiring

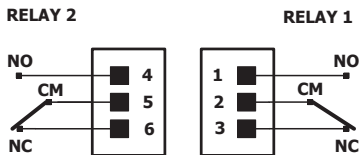

8A/250V MAX.

Important: To guarantee electrical safety according to EN 61010-1 a protective 8A/250V external fuse must be installed.

## Display and Key Pad

**Pro** mode is when configuration menu is entered to program the indicator. **RUN** is the normal mode in which display shows the reading according to configuration and input signal value.

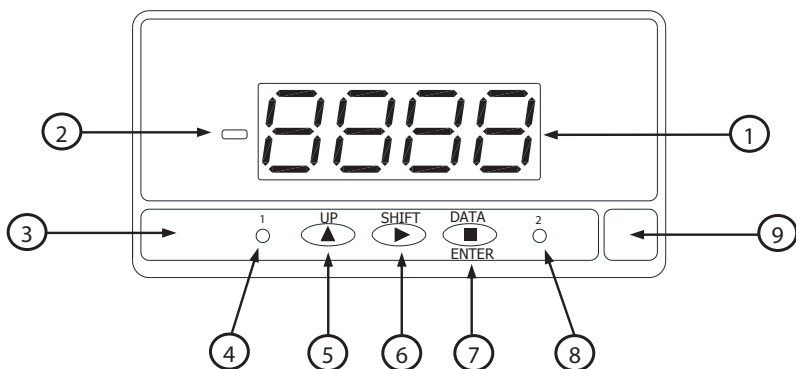

Programming Panel			
#	Description	Run Mode	Programming Mode
1	4 digit display Red	Shows value according to configuration.	Shows steps and data during configuration.
2	Minus sign	Illuminates for negative readings.	Illuminates for negative values.
3	Key Pad	---	---
4	Setpoint 1 LED	Illuminates when setpoint 1 turns active.	Illuminates when setpoint 1 turns active.
5	UP key	No application	Shows setpoint value. Increases value of active digit.
6	SHIFT key	Displays maximum and minimum stored values. After 3s of pressing, sets maximum and/or minimum memorized value to current display value.	Shifts active digit to the next right digit.
7	DATA/ENTER key	Changes to PRO mode.	Validates selected data and parameters. Moves one step forward in configuration menu. Changes to RUN mode.
8	Setpoint 2 LED	Illuminates when Setpoint 2 turns active.	Illuminates when Setpoint 2 turns active.
9	Free space for units label	---	---

## Configuration

When the power is applied to the meter, a display test begins automatically to check the function of LED's and digits. Once this test is finished the display shows the internal software version and then the unit goes to **RUN** mode.

Configuration follows a structure composed of a number of menus and submenus. By pressing **ENTER** key, display shows "**Pro**", pressing again allows access to the main menu level which includes the menus for input configuration (**InP**), display configuration (**dSP**) and relay setpoints configuration (**SEtP**) if relays are present in the meter.

If configuration has been totally locked-out, when pressing **ENTER** key to get into main menu, display shows "**dAtA**" instead of "**Pro**". This indicates that it is only possible to see programmed information and that it is not allowed to modify any parameter from the entire configuration. In this visualization mode, the meter automatically switches back to **RUN** mode after 15 seconds since last key press.

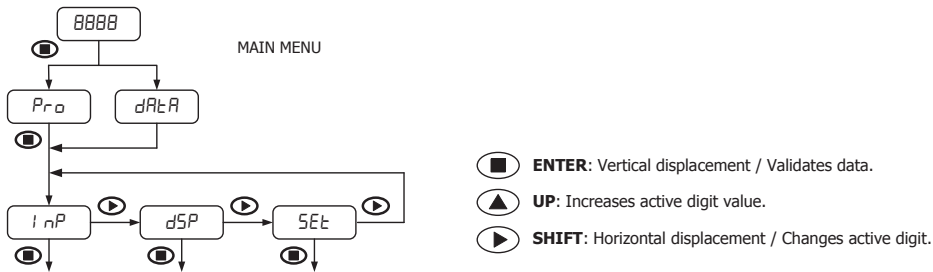

Once inside each menu, all configuration parameters are sequentially shown and they can then be introduced or edited by pressing **ENTER** key. Numeric values must be entered digit by digit, by first selecting the digit using the **SHIFT** key and then changing its value with the **UP** key. When the desired display value is reached, press the **ENTER** key to validate the data and move forward to next configuration step.

Data entered or changed during configuration are stored in device memory only when configuration routine belonging to the respective submenu is completed, not before. On last routine step and after having pressed **ENTER** key, display indicates "**StorE**" and the unit goes back again to **RUN** mode.

### Input Configuration

The first menu corresponds to input configuration. This, in turn, consists of four submenus, one for each input type: process (**ProC**), temperature (**tEMP**), potentiometer (**Pot**) and resistance (**rES**).

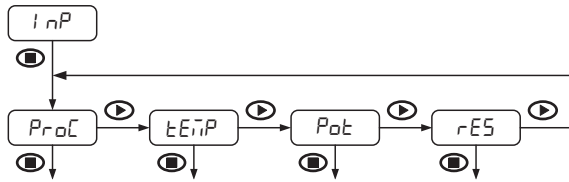

### Process

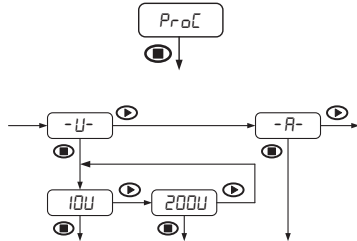

The parameters to be configured in input process submenu are:

**Input Type:**

**V:** ±10V or ±200V

**A:** ±20mA

### Temperature

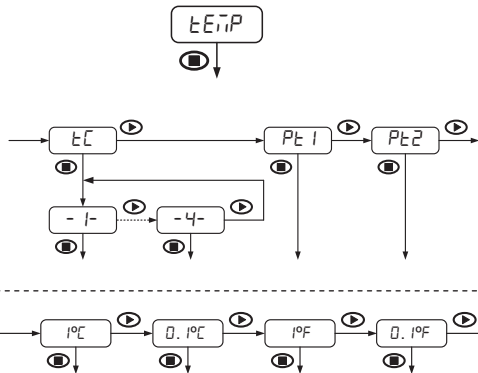

The parameters to be configured in input temperature submenu are:

**Sensor Type:**

**tC:** Thermocouple J(1), K(2), T(3) or N(4)

**Pt1:** Pt100 sensor

**Pt2:** Pt1000 sensor

**Display Resolution:**

Select from degree or tenths of degree resolution in Celsius or Fahrenheit.

### Display Offset

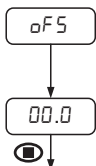

-9.9 to +9.9 display counts if a tenths of degree resolution is selected

-99 to +99 display counts if a degree resolution is selected

Usually it will not be necessary to introduce any offset value, except in cases where a known difference between temperature measured by the sensor and real temperature should be compensated.

## Potentiometer

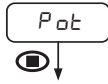

No additional configuration is needed for this input type (direct validation).

## Resistance

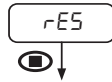

The only parameter to be configured in input resistance submenu is:



RESISTANCE RANGE:

999.9 to 999.9Ω (1kΩ) Range

9999 to 9999Ω (10kΩ) Range

50.00 to 50.00kΩ (50kΩ) Range

## Display Configuration

The second menu corresponds to display configuration consisting of submenus according to previously programmed input type.

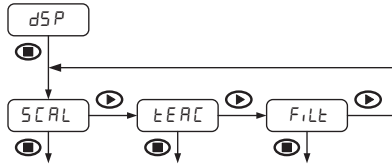

THROUGH FRONTAL KEYS CONFIGURATION “**SCAL**”

Input and display values are configured manually through the three keys of the instrument. This method is suitable when signal values supplied by the transducer at each extreme point of the process are known.

REAL INPUT SIGNAL CONFIGURATION “**tEAC**”

Input values are entered by introducing actual process values. The input signal device must be connected to the meter at the CN2 input connector and operational. Display values are configured manually through the three keys, as in the previous case. This method is suitable when signal values at each point are unknown but, it is possible to drive the process to the conditions defined by these extreme points.

WEIGHTED AVERAGE FILTER “**FiLt**”

Sets low-pass filter cutoff frequency ( $F_c$ ) which allows the meter to smooth out undesirable display reading fluctuations.

## Display Scaling

Display scaling is necessary when adapting display reading to a particular engineering unit. Display range can be configured between **-9999** and **9999** for the DPM2 or **-1999 to 9999** for the DPM2L.

Display scaling is a linear process that consists in introducing two input values, referred as Input 1 and Input 2, and their respective display values, referred as Display 1 and Display 2. On the basis of this proportional relationship internal software calculates display value that would correspond to a given input value. Decimal point position is selectable and completes the engineering units indication configuration.

It is possible to scale display in an direct acting (increasing) or reverse acting (decreasing) proportional mode depending on whether the second display value (**DISP.2**) is greater or less than the first (**DISP.1**). In an increasing mode, display value increases proportionally to the input value whereas in a decreasing mode, display value decreases.

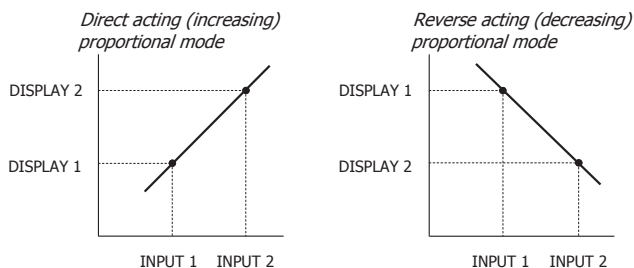

### IMPORTANT IN “tEAC” MODE:

To ensure the best accuracy, both points 1 and 2 should represent extreme process limits.

The figure below shows an example for a 10 bar pressure sensor with a 4-20mA output signal. Decimal point is situated between second and third digit of the display.

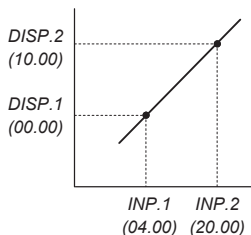



## Process Input

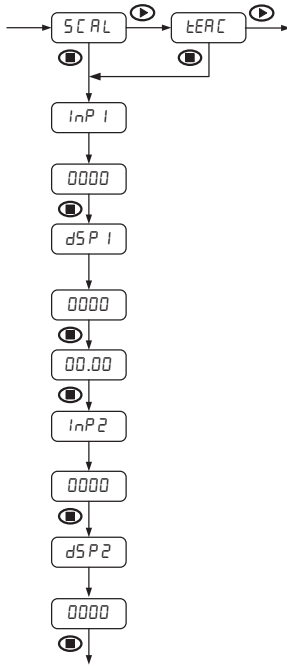

In “SCAL” method, all values must be manually introduced through the three frontal keys whereas in “tEAC” method, input signal value must be present at the connector at each point that is intended to be configured.

### FIRST POINT INPUT AND DISPLAY VALUE:

- InP1:** Input value indication.
- 000:** Value entered in counts within available model display range.
- dSP1:** Display value indication.
- 0000:** Value entered in counts within display range.

### DECIMAL POINT:

- 00.00:** Setting of decimal point position. (Decimal point can be located in any position, and will be the same for Display 1 and Display 2. This position remains fixed for all configuration steps and also for RUN mode).

### SECOND POINT INPUT AND DISPLAY VALUE:

- InP2:** Input value indication.
- 0000:** Value entered in counts within display range.
- dSP2:** Display value indication.
- 0000:** Value entered in counts within display range.

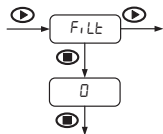

### WEIGHTED AVERAGE FILTER:

- FiLt:** 0 to 9 selectable for low pass filter cut-off frequency.



Value	Fc (Hz)	Value	Fc (Hz)
0	--	5	2.2
1	7.3	6	1.6
2	5.1	7	1.1
3	3.8	8	0.5
4	2.9	9	0.2

## Temperature Input

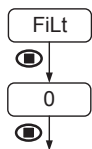

When programmed input type is temperature, thermocouple or Pt100 or Pt1000 sensor, the only parameter to configure is the filter and its configuration is done in the same way as described for process input.

Display scaling is not available for this input type, the unit then will assume a fixed calibrated range depending on sensor type and previously configured units resolution

## Potentiometer Input

When programmed input type is potentiometer, “tEAC” is the only method available to perform display scaling.

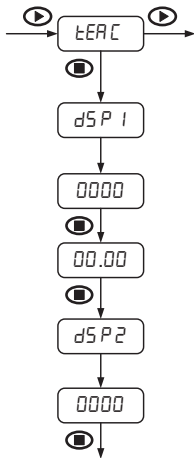

In this case, it must be assured first that potentiometer is connected properly and that it is not subjected to any external voltage.

After pressing **ENTER** key, the instrument analyzes connected potentiometer to internally determine both maximum and minimum resistive values. Once this calculation have finished, display shows “dSP1”.

FIRST POINT DISPLAY VALUE:

**dSP1:** Display value indication.

**0000:** Value entered in counts within display range.

**(potentiometer wiper must correspond to process first point).**

DECIMAL POINT:

**00.00:** Setting of decimal point position. (Decimal point can be located in any position, and will be the same for Display 1 and Display 2. This position remains fixed for all configuration steps and also for RUN mode).

SECOND POINT DISPLAY VALUE:

**dSP2:** Display value indication.

**0000:** Value entered in counts within display range.

**(potentiometer wiper must correspond to process second point).**

WEIGHTED AVERAGE FILTER:

**Filt:** 0 to 9 selectable for low pass filter cut-off frequency.



Value	Fc (Hz)	Value	Fc (Hz)
0	--	5	2.2
1	7.3	6	1.6
2	5.1	7	1.1
3	3.8	8	0.5
4	2.9	9	0.2

## Resistance Input

When programmed input type is resistance, the display can be manually scaled by selecting (**uSEr**) or the display can be scaled to fixed calibrated ranges (**CAL**) depending on the resistance range previously configured.

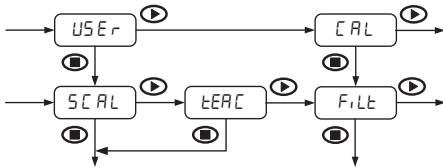

Display scaling is possible through frontal keys (“**SCAL**”) and through real input signal (“**tEAC**”) as described for process input. If the fixed calibrated range option “**CAL**” is selected, the programming routine goes directly to the filter configuration (“**FiLt**”) with no option to return to scaling configuration.

Filter configuration is done in the same way as described for process input.

## Relay Setpoint Configuration

The third menu “SEtP” only appears for the DPM2 with relay outputs.

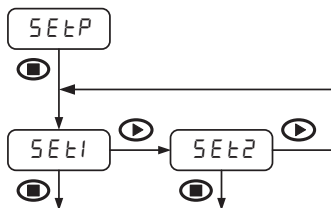

### RELAY OUTPUT OPTION

Programming steps are equal for both relays on each “SEt1” and “SEt2” submenus. The parameters to be configured are the following:



### SETPOINT VALUE:

**00.00:** Value entered in counts within display range. (The decimal point position is previously defined in display configuration menu).

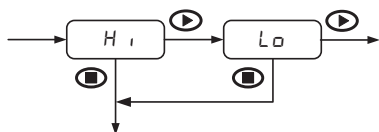

### ACTIVATING MODE:

**Hi:** High level relay activation.

**Lo:** Low level relay activation.

In HI mode, relay output activates when display value goes above setpoint level, whereas in LO mode, relay output activates when display value falls below setpoint level.

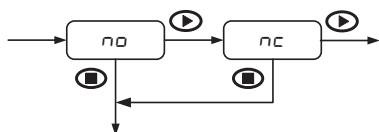

### RESTING CONTACTS STATE:

**NO:** Normally open contact.

**NC:** Normally closed contact.

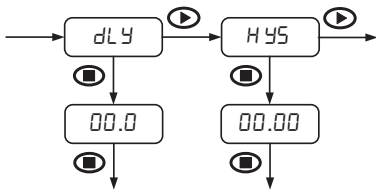

**TIME DELAY OR HYSTERESIS:**

**dLy:** Programmable delay from 0 to 99.9s.

**HyS:** Hysteresis in counts within display range.

**Time Delay:**

Both relay output actions can be controlled by a configurable time delay from 0 up to 99.9 seconds.

Time delay activation starts when display value reaches each setpoint 'SET' either increasing or decreasing.

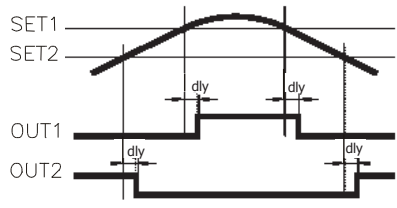

Time delay for OUT1 (HI mode) and for OUT2 (LO mode)

**Asymmetrical Hysteresis:**

Both relay output actions can be controlled by a hysteresis level which is configurable in counts within full available display. Decimal point position is the previously defined in display configuration menu.

Asymmetrical hysteresis action only starts in the output deactivation edge, the 'hys' as indicated on the right figure.

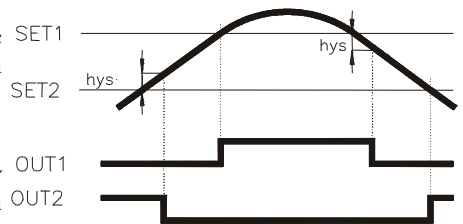

Hysteresis delay for OUT1 (HI mode) and for OUT2 (LO mode)

Note that outputs activation is not affected by hysteresis and they activate in each case just when setpoint 'SET' is reached by display.

## Additional Functions

### MAX/MIN and RESET Functions

This device detects and stores in memory maximum and minimum values reached by the input signal. These values are kept in memory although power supply is disconnected. When repeatedly pressing SHIFT key, MAX/MIN function shows saved maximum and minimum values in display since last RESET function activation.

In order to differentiate this value's indication from RUN mode indication, decimal point blinks while these values are shown. The unit automatically switches back to RUN mode after 15 seconds have elapsed since the last key press.

First SHIFT key pressing shows "MAH" in display followed by the maximum value, a second pressing now shows "Min" followed by the minimum value and finally, a third pressing shows "run" before returning to RUN mode.

RESET function is activated while visualizing maximum or minimum values and the SHIFT key is pressed for at least 3 seconds. If maximum is the displayed value, current input signal value will replace the previous maximum saved value. In the same way, current input signal will replace saved minimum value while the minimum value is displayed.

### Direct Access to Setpoints Value

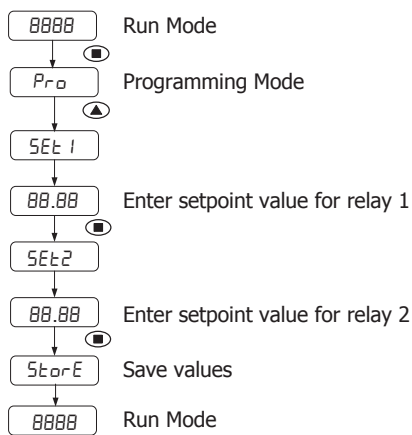

If the DPM2 has relay outputs, it is possible to access setpoints value configuration without having to enter main menu.

To access this submenu, from **RUN** mode **ENTER** key is pressed, and then press **UP** key while "Pro" is displayed.

FIRST SETPOINT VALUE:

SEt1: Setpoint 1 value indication.

**00.00:** Value entered in counts within display range.

SECOND SETPOINT VALUE:

SEt2: Setpoint 2 value indication.

**00.00:** Value entered in counts within display range.

## Return to Factory Configuration

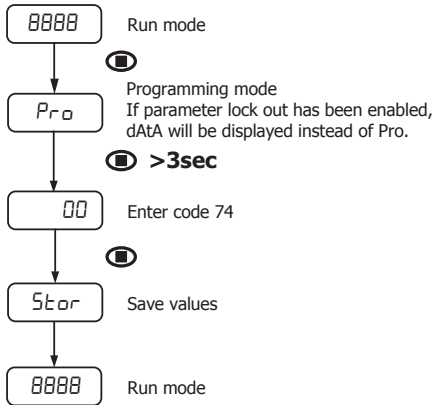

To access this menu from **RUN** mode, press **ENTER** key and while display shows “**Pro**” press again **ENTER** for at least 3 seconds.

Display shows now “**00**” and ‘74’ code must be introduced through **SHIFT** and **UP** keys.

Finally press **ENTER** to validate configuration and back to **RUN** mode.

## Configuration Lock-Out

In order to prevent accidental or undesirable modifications of instrument parameters, a selective or total configuration lock-out is available. By default the unit is delivered unlocked, giving access to all programming levels. Once in this menu, the first option will be to choose between lock-out level setting (“**LiSt**”) or security access code changing (“**CHAn**”).

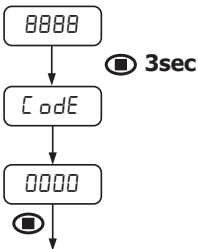

To access this menu from **RUN** mode, press **ENTER** key for at least 3 seconds.

Display now shows “**Code**” and then “**0000**”. Desired security code must be introduced through **SHIFT** and **UP** keys (by default this code is **0000**).

Finally press **ENTER** to begin with lock-out level configuration. If entered security code is wrong, the instrument will go back to **RUN** mode.

## Configuration Lock-Out Continued

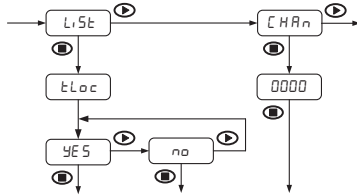

If “**LiSt**” option is selected, display will show momentarily “**tLoc**”. Total configuration lock-out is activated by selecting “**YES**”, then routine directly jumps to MAX/MIN lock-out configuration before the unit goes back to **RUN** mode. When total lock-out is set, no data can be entered or modified, although it will still be possible to visualize all programmed parameters. Under these conditions when entering main menu, initial indication will be “**dAtA**” instead of “**Pro**”.

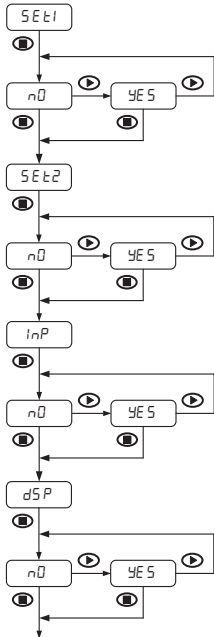

On the other hand, when “**no**” option is selected, routine moves on to next step to configure a selective lock-out. **When a selective lock-out is set, only non-locked data can be entered or modified.** Under these conditions when entering main menu, initial indication will be “**Pro**”.

The following configuration access can be locked-out:

- Setpoint 1 configuration (**SEt1**)
- Setpoint 2 configuration (**SEt2**)
- Input configuration (**InP**)
- Display configuration (**dSP**)

SHIFT key configuration for MAX/MIN function (**MAH**)

In each case lock-out is activated by selecting “**YES**” option and deactivated by selecting “**no**”. Setpoints 1 and 2 configuration lock-out is available only if the DPM2 has output relays.



## Configuration Lock-Out Continued

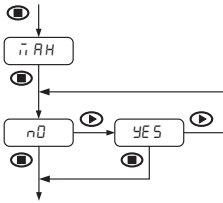

It is possible to configure SHIFT key lock-out for MAX/MIN function in the same way as previous configurations.

When lock-out is enabled (selecting “YES”) it is not possible to visualize maximum or minimum values by pressing SHIFT key, although instrument internally continues detecting and saving new extreme values reached by input signal.

Once the instrument programming is completed, if there are parameters that are going to be frequently changed, a partial lock-out is recommended. A total lock-out is recommended when configuration parameters will be constant for a long time.

Changing default security code and keep new one in a safe place is also strongly recommended.

## Technical Specifications

Technical Specifications					
<b>Process Input</b>	<b>Range</b>	<b>Input Impedance</b>	<b>Resolution</b>	<b>Accuracy</b>	
	±20mA	<20Ω	2μA	±(0.1% rdg+15μA)	
	±10V	2MΩ	1mV	±(0.1% rdg+6mV)	
	±200V	2MΩ	20mV	±(0.1% rdg+0.1V)	
<b>Sensor Excitation</b>	24V±3V @ 30mA				
<b>Potentiometer</b>	<b>Range</b>	<b>Maximum Measurement Current</b>	<b>Resolution</b>	<b>Accuracy</b>	
	100-100kΩ	<0.4mA	0.01% F.S.	±(0.1% rdg+0.05% F.S.)	
<b>Resistance</b>	999.9Ω	2.3mA	0.1Ω	±(0.1% rdg+0.7Ω)	
	9999Ω	230μA	1Ω	±(0.1% rdg+6Ω)	
	50kΩ	23μA	10Ω	±(0.1% rdg+35Ω)	
<b>Temperature</b>	<b>RTD</b>	<b>Pt100 (3 wire)</b>		<b>Pt1000 (2 wire)</b>	
	Fixed Display Range / Resolution	-200.0°C to 800.0°C / 0.1°C -200°C to 800°C / 1°C -328.0°F to 999.9°F / 0.1°F -328°F to 1472°F / 1°F			
	Measurement current	1mA		100μA	
	Maximum resistance per wire	40Ω (balanced)		-	
	Linearization	IEC 60751			
	Coefficient	0.00385			
	Accuracy	±(0.15% rdg+0.5°C), t<-50°C ±(1% rdg+0.5°C) ±(0.15% rdg+0.9°F), t<-58°F ±(1% rdg+0.9°F)			
	<b>Thermocouple</b>	<b>J</b>	<b>K</b>	<b>T</b>	<b>N</b>
	Fixed Display Range / Resolution	-150.0°C to 999.9°C / 0.1°C -150°C to 1100°C / 1°C -238.0°F to 999.9°F / 0.1°F -238°F to 2012°F / 1°F	-150.0°C to 999.9°C / 0.1°C -150°C to 1200°C / 1°C -238.0°F to 999.9°F / 0.1°F -238°F to 2192°F / 1°F	-150.0°C to 400.0°C / 0.1°C -150°C to 400°C / 1°C -238.0°F to 752.0°F / 0.1°F -238°F to 752°F / 1°F	-150.0°C to 999.9°C / 0.1°C -150°C to 1300°C / 1°C -238.0°F to 999.9°F / 0.1°F -238°F to 2372°F / 1°F
	Cold junction compensation range	-10°C to 60°C (14°F to 140°F)			
	Accuracy	±(0.1% rdg+0.6°C) ±(0.1% rdg+1.1°F)		±(0.2% rdg+0.8°C) ±(0.2% rdg+1.5°F)	±(0.1% rdg+0.6°C) ±(0.1% rdg+1.1°F)

**Technical Specifications Continued**

<b>Conversion</b>	Technique	Sigma-Delta
	Resolution	±16 bits
	Conversion rate	20 times per second
<b>Display</b>	Range	-9999 to +9999 (-1999 to +9999 for large display models), selectable decimal point position
	Type	4 digit, 14mm (0.55") or 20mm (0.79"), red
	LEDs	Relay 1, Relay 2
	Display refresh rate	20 times per second
	Display / Input overrange indication	"- OUE", "OUE"
<b>Accuracy Conditions</b>	Temperature coefficient	100 ppm/°C
	Warm-up time	5 minutes
	Temperature	23°C±5°C
<b>Relays (DPM2-AT-2RL-HL only)</b>	2 Relays SPDT	Nominal contact rating.....8A at 250VAC / 24VDC Maximum switching current (resistive load).....8A Maximum switching power.....2000VA / 192W Maximum switching voltage.....400VAC / 125VDC Contact resistance.....≤100mΩ at 6VDC @ 1A Contact type.....SPDT Operate time.....≤10ms
<b>Power Supply and Fuses</b>	20-265VAC 50/60 Hz or 11-265VDC (Recommended fusing 3A/250V, DIN 41661)	
<b>Power Consumption</b>	3W	
<b>Filter</b>	Cutoff frequency (-3dB)	7.3Hz to 0.2Hz
	Slope	-20dB/Dec.
<b>Environmental Conditions</b>	Operating temperature	-10°C to +60°C (14°F to 140°F)
	Storage temperature	-25°C to +85°C (-13°F to 185°F)
	Relative humidity (non-condensing)	<95% @ 40°C (104°F)
	Maximum altitude	2000m
	Frontal protection degree	IP65
<b>Environmental Air</b>	No corrosive gases permitted	
<b>Agency Approval</b>	CE	

## Instrumentation Configuration Notes

### INPUT:

TYPE:

RANGE:

### DISPLAY:

CONFIG. MODE:  SCAL  TEACH  CAL

INPUT 1:

DISPLAY 1:

INPUT 2:

DISPLAY 2:

FILTER (0 ÷ 9):

### SETPOINTS:

SET1:

MODE:  no  nc

DLY:

HYS:

SET2:

MODE:  no  nc

DLY:

HYS:

### LOCK-OUT:

ACCESS CODE: