

INSTALLATION AND WIRING



CHAPTER 2

In this Chapter...

Ambient Conditions	2-2
Installation Considerations.....	2-2
Mounting Instructions	2-3
Controller and Panel Cutout Dimensions	2-4
Safety Information	2-6
Terminal Identification.....	2-8
SL4824 Series Inputs	2-8
SL4824 Series Wiring.....	2-9
SL4848 Series Inputs.....	2-10
SL4848 Series Wiring.....	2-11
SL4896 Series Inputs.....	2-12
SL4896 Series Wiring.....	2-13
SL9696 Series Inputs.....	2-14
SL9696 Series Wiring.....	2-15

Ambient Conditions

Ambient Conditions	
Ambient Temperature Range	32°F to 122°F (0°C to 50°C)
Storage Temperature Range	-4°F to 149°F (-20°C to 65°C)
Relative Humidity	35% to 80% (non-condensing)
Altitude	2000m or lower above sea level, keep from corrosive gas, liquid and dust
Pollution Degree	Degree 2 - Normally, only non-conductive pollution occurs. Temporary conductivity caused by condensation is to be expected
Vibration Resistance	10 to 55 Hz, 10 m/s ² for 10 min, each in X, Y and Z directions
Shock Resistance	Max. 300 m/s ² , 3 times in each 3 axes, 6 directions
IP Rating	IP65: Complete protection against dust and low pressure spraying water from all directions when mounted in a suitable enclosure.

Installation Considerations

Improper installation of the controller will greatly reduce its life. Be sure to observe the following precautions when selecting a mounting location:



Warning: Failure to observe these precautions may damage the controller and void the warranty!

- Do not mount the controller near heat-radiating elements or in direct sunlight.
- Do not install the controller in a place subjected to high temperature, high humidity, excessive vibration, corrosive gases or liquids, or airborne dust or metallic particles.
- Do not restrict the air flow to the vent opening on the controller housing
- This controller is an open-type unit and must be placed in an enclosure to ensure proper operation and maintain the IP65 rating.

Mounting Instructions

SL4824 Series

Series SL4824 temperature controllers should be mounted through a cutout in an enclosure or panel by using the dimensions shown on page 2–4. The directions for mounting the controller through a cutout are...

1. Insert the temperature controller through the panel cutout.
2. Slide the M3X0.5 nut into the opening in the top of the mounting bracket and insert the M3X0.5 X 30mm mounting screw in the mounting bracket.
3. Slide the mounting bracket onto the controller and push the mounting bracket forward until the bracket stops.
4. Tighten the M3X0.5 X 30mm screw to secure temperature controller in place.

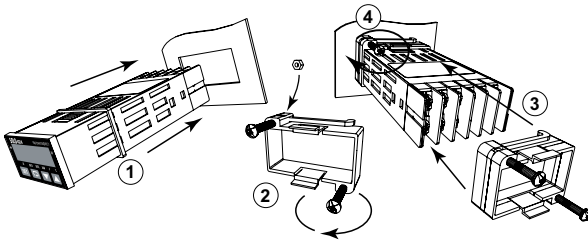

SL4848, SL4896, SL9696 Series

Series SL4848, SL4896 and SL9696 temperature controllers should be mounted through a cutout in an enclosure or panel by using the dimensions shown on page 2–4 and page 2–5. The directions for mounting the controller through a cutout are...

1. Insert the temperature controller through the panel cutout.
2. Slide the M3X0.5 nut into the opening in the top of the mounting bracket and insert the M3X0.5 X 30mm mounting screw in the mounting bracket.
3. Insert the mounting bracket into the mounting groove at the top and bottom of the controller, and push the mounting bracket forward until the bracket stops.
4. Tighten top and bottom screws evenly to secure temperature controller in place.

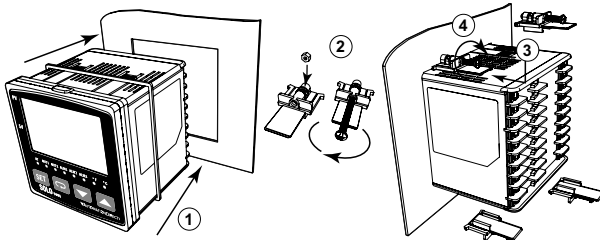

Controller and Panel Cutout Dimensions

SL4824 Series

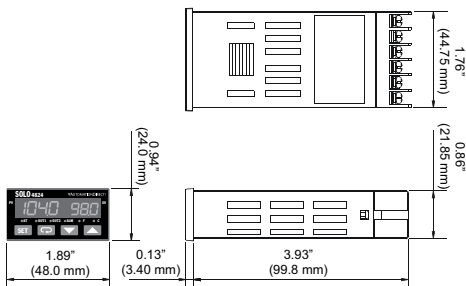

Minimum Cutout and Spacing

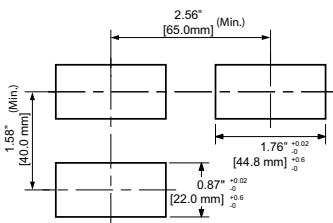

SL4848 Series

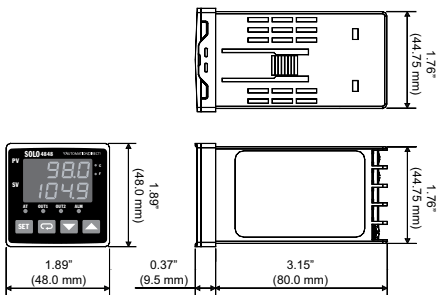

Minimum Cutout and Spacing

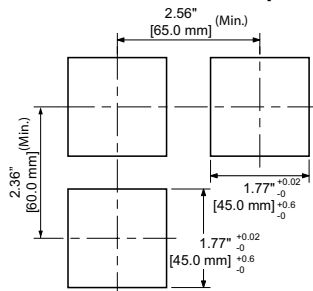

Controller and Panel Cutout Dimensions, cont'd

SL4896 Series

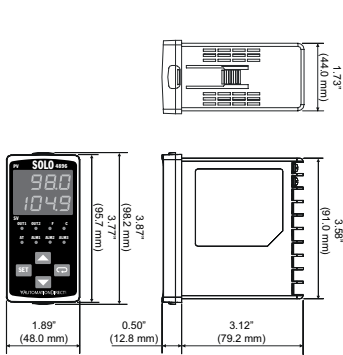

Minimum Cutout and Spacing

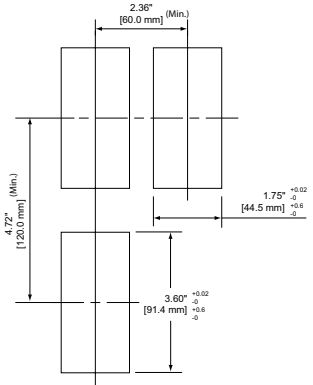

SL9696 Series

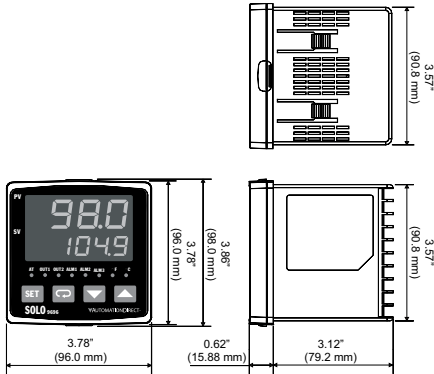

Minimum Cutout and Spacing

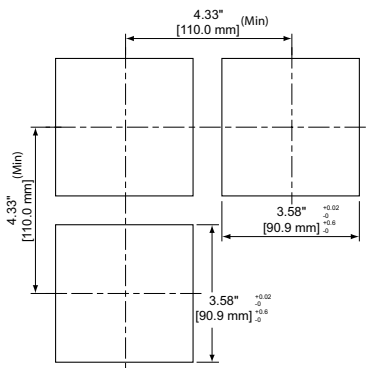

Safety Information

DANGER!



Warning: To minimize the risk of potential safety problems, you should follow all applicable local and national codes that regulate the installation and operation of your equipment. These codes vary from area to area and it is your responsibility to determine which codes should be followed, and to verify that the equipment, installation, and operation are in compliance with the latest revision of these codes



Warning: To prevent electric shock, do not touch the AC terminals while power is supplied to the controller.



Warning: This controller is an open-type temperature controller. make sure to evaluate any dangerous application in which a serious human injury or serious property damage may occur.

Wiring Notes: PLEASE READ PRIOR TO INSTALLATION.

Equipment damage or serious injury to personnel can result from the failure to follow all applicable codes and standards. We do not guarantee the products described in this publication are suitable for your particular application, nor do we assume any responsibility for your product design, installation, or operation.

If you have any questions concerning the installation or operation of this equipment, or if you need additional information, please call us at 1-800-633-0405 or 770-844-4200.

This publication is based on information that was available at the time it was printed. At AutomationDirect.com® we constantly strive to improve our products and services, so we reserve the right to make changes to the products and/or publications at any time without notice and without obligation. This publication may also discuss features that may not be available in certain revisions of the product.

1. Always use recommended solder-less terminals: Fork terminal with isolation (M3 screw, width is 7.0mm, hole diameter 3.2mm). Screw size: M3 x 6.5 (With 6.8 x 6.8 square washer). Recommended tightening torque: 0.4 Nm (4kgfcm). Applicable wire: Solid/twisted wire of 2 mm, 12AWG to 24AWG. Choose AutomationDirect fork terminals part numbers BM-00120, BM-00220 or BM-00320 depending on wire size. Be sure to tighten them properly.
2. Protect the controller from dust or foreign objects as they can cause the controller to malfunction.
3. Never modify or disassemble the controller.
4. Do not connect anything to the “Not used” terminals.
5. Make sure all wires are connected to the correct polarity of terminals.
6. Do not install and/or use the controller in places subject to: (a) Dust or corrosive gases and liquid (b) High humidity (c) Vibration or shock (d) EMI / RFI (e) high temperature.
7. Power must be turned off when wiring or changing a sensor.

Safety Information, cont'd

8. Be sure to use wires that match the thermocouple types when extending or connecting thermocouple wires.
9. Use wires with correct resistance when extending or connecting a RTD.
10. Keep the wire as short as possible when wiring a RTD to the controller and route power wires as far as possible from sensor wires to prevent interference and induced noise.
11. This controller is an open-type unit and must be placed in an enclosure to ensure proper operation and maintain the IP65 rating.
12. Make sure power cables and signals from instruments are all installed properly before energizing the controller, otherwise serious damage may occur.
13. To prevent electric shock, do not touch the terminals on the controller or try to repair the controller when power is applied.
14. Do not use acid or alkaline liquids for cleaning. Use a soft, dry cloth to clean the controller.
15. This instrument is not furnished with a power switch or fuse. Therefore, if a fuse or power switch is required, install the protection close to the instrument. Recommended fuse rating: Rated voltage 250 V, Rated current 1 A. Fuse type: Time-delay fuse. See the AutomationDirect catalog for the appropriate fuse for the specific application.
16. Note: This controller does not provide overcurrent protection. Use of this product requires that suitable overcurrent protection device(s) must be added to ensure compliance with all relevant electrical standards and codes. (Rated 250 V, 15 Amps max). A suitable disconnecting device should be provided near the controller in the end-use installation.

Terminal Identification

SL4824 Series Inputs

Power Input

AC Models Power Input

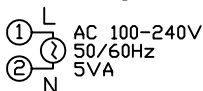

DC Models Power Input

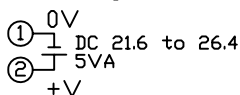

Sensor Input

0 – 10 VDC

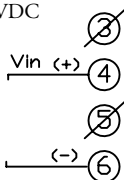

4-20 mA

For 4-20mA sensor input install supplied 249Ω resistor.

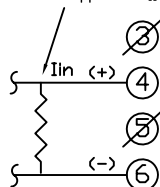

2-wire RTD

Install jumper when using 2 wire RTD

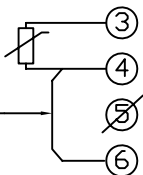

3-wire RTD

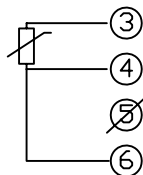

Thermocouple

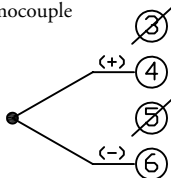

Terminal Identification cont'd

SL4824 Series Wiring

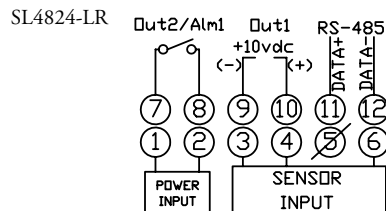
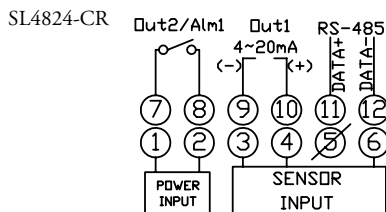
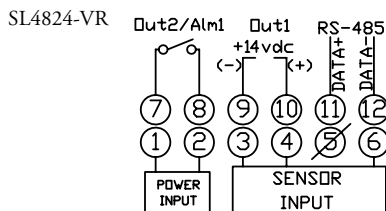
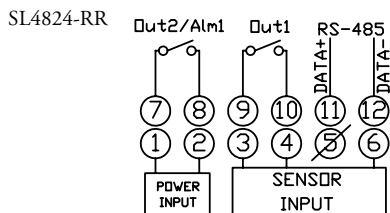

Terminal Identification, cont'd

SL4848 Series Inputs

Power Input

AC Models Power Input

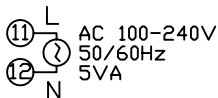

DC Models Power Input

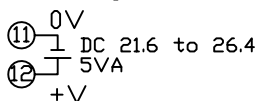

Sensor Input

0 – 10 VDC

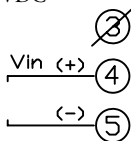

4-20 mA

For 4~20mA sensor input
install supplied 249Ω resistor.

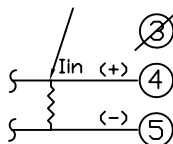

2-wire RTD

Install jumper when using
2 wire RTD

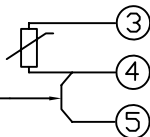

3-wire RTD

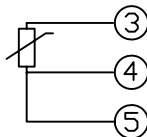

Thermocouple

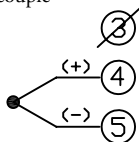

Terminal Identification, cont'd

SL4848 Series Wiring

SL4848-RR

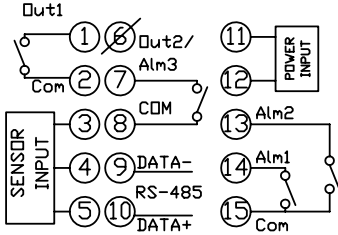

SL4848-LV & SL4848-VV

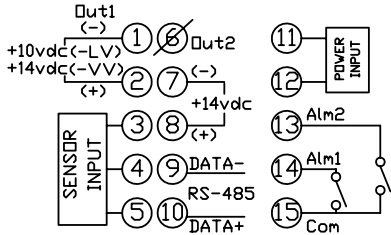

SL4848-VR

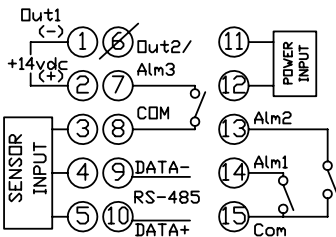

SL4848-CR

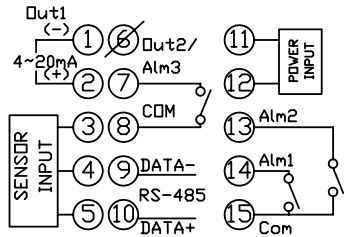

SL4848-CV

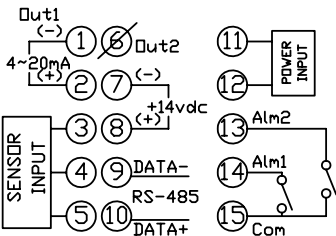

SL4848-LR

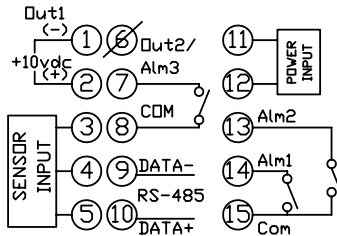

Terminal Identification, cont'd

SL4896 Series Inputs

Power Input

AC Models Power Input

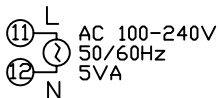

DC Models Power Input

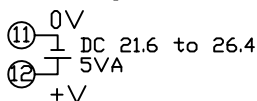

Sensor Input

0 – 10 VDC

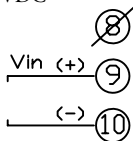

4-20 mA

For 4~20mA sensor input
install supplied 249Ω resistor.

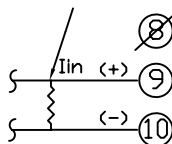

2-wire RTD

Install jumper when using
2 wire RTD

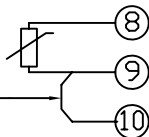

3-wire RTD

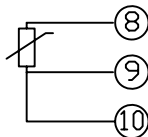

Thermocouple

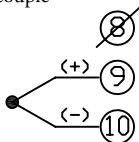

Terminal Identification, cont'd

SL4896 Series Wiring

SL4896-RRE

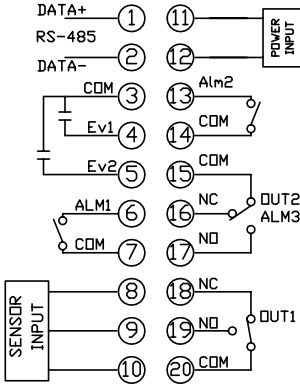

SL4896-CRE

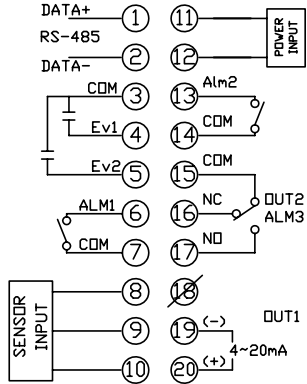

SL4896-VRE

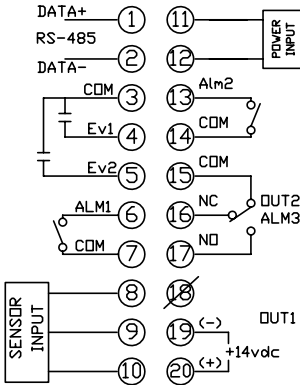

SL4896-LRE

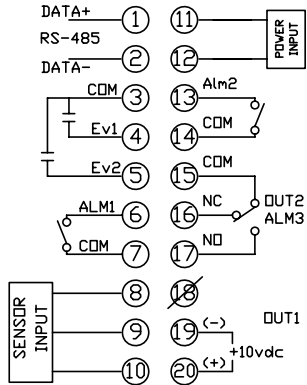

Terminal Identification, cont'd

SL9696 Series Inputs

Power Input

AC Models Power Input

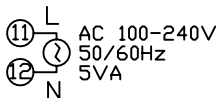

DC Models Power Input

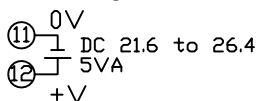

0 – 10 VDC

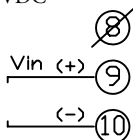

4-20 mA

For 4~20mA sensor input
install supplied 249 Ω resistor.

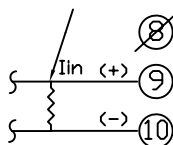

2-wire RTD

Install jumper when using
2 wire RTD

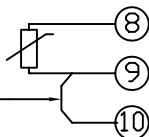

3-wire RTD

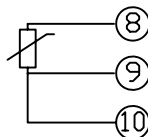

Thermocouple

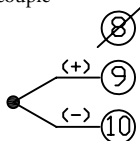

Terminal Identification, cont'd

SL9696 Series Wiring

SL9696-RRE

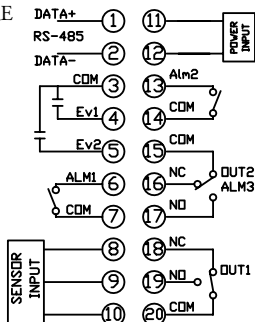

SL9696-LRE

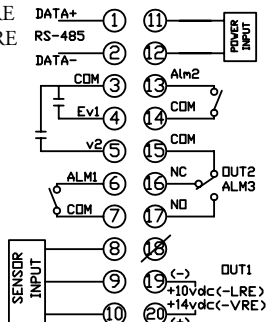

SL9696-CRE

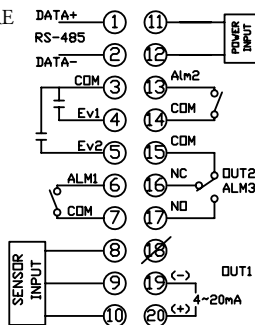

SL9696-CVE

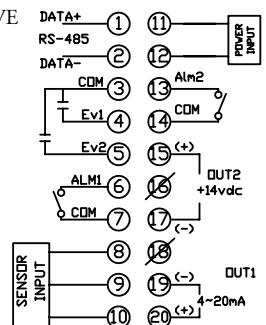

SL9696-VVE

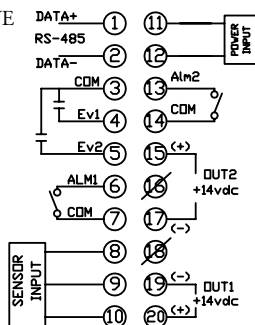

SL9696-LVE

