

SureStep™ STEPPING SYSTEMS

Advanced Microstepping Drives
STP-DRV-4850 & STP-DRV-80100



WARNING

To minimize the risk of potential safety problems, you should follow all applicable local and national codes that regulate the installation and operation of your equipment. These codes vary from area to area. It is your responsibility to determine which codes should be followed, and to verify that the equipment, installation, and operation are in compliance with the latest revision of these codes.

Equipment damage or serious injury to personnel can result from the failure to follow all applicable codes and standards. We do not guarantee the products described in this publication are suitable for your particular application, nor do we assume any responsibility for your product design, installation, or operation.

If you have any questions concerning the installation or operation of this equipment, or if you need additional information, please call our technical support group at 770-844-4200.

This publication is based on information that was available at the time it was printed. At *Automationdirect.com*® we constantly strive to improve our products and services, so we reserve the right to make changes to the products and/or publications at any time without notice and without obligation. This publication may also discuss features that may not be available in certain revisions of the product.

SureStep™ Series Specifications – Microstepping Drives		
Microstepping Drive	STP-DRV-4850	STP-DRV-80100
Drive Type	Advanced microstepping drive with pulse or analog input, serial communication (serial communication allows indexing capability)	
Output Current	0.1-5.0 A/phase (in 0.01A increments)	0.1-10.0 A/phase (in 0.01A increments)
Input Voltage (external p/s required)	24-48 VDC (nominal) (range: 18-53 VDC)	24-80 VDC (nominal) (range: 18-88 VDC)
Configuration Method	SureStep Pro software (included)	
Amplifier Type	MOSFET, dual H-bridge, 4-quadrant	
Current Control	4-state PWM @ 20 kHz	
Protection	over-voltage, under-voltage, over-temperature, external output faults (phase-to-phase & phase-to-ground), inter-amplifier shorts	
Recommended Input Fusing	Fuse: 4A 3AG delay (ADC #MDL4) Fuse Holder: ADC #DN-F6L110	Fuse: 6.25A 3AG delay (ADC #MDL6-25) Fuse Holder: ADC #DN-F6L110
Input Signals	Input Circuit	Opto-coupler input with 5 to 15 mA input current; Logic Low is input 0.8 VDC or less; Logic High is input 4 VDC or higher.
	Step/Pulse	optically isolated, differential, 5V, 330Ω min pulse width = 250 ns max pulse frequency = 2MHz adjustable bandwidth digital noise rejection feature
	Direction	FUNCTIONS: step & direction, CW/CCW step, A/B quadrature, run/stop & direction, jog CW/CCW, CW/CCW limits
	Enable	optically isolated, 5-12V, 680Ω; FUNCTIONS: motor enable, alarm reset, speed select (oscillator mode)
	Analog	Range: 0-5 VDC; Resolution: 12 bit; FUNCTION: speed control
Output Signal	optically isolated, 24V, 10 mA max; FUNCTIONS: fault, motion, tach	
Communication Interface	RS-232; RJ11 (6P4C) receptacle	
Non-volatile Memory Storage	Configurations are saved in FLASH memory on-board the DSP.	
Features	Idle Current Reduction	reduction range of 0-90% of running current after delay selectable in ms
	Microstep Resolution	software selectable from 200 to 51200 steps/rev in increments of 2 steps/rev
	Modes of Operation	step & direction, CW/CCW, A/B quadrature, oscillator, joystick, serial commands
	Phase Current Setting	0.1-5.0 A/phase (in 0.01A increments) 0.1-10.0 A/phase (in 0.01A increments)
	Self Test	checks internal & external power supply voltages, diagnoses open motor phases
Additional Features	Anti-resonance (Electronic Damping) Auto setup Microstep emulation Torque ripple smoothing (allows for fine adjustment of phase in the range 0.25 to 1.5 rps) Waveform (command signal) smoothing	
Connectors	Communication: RJ11 (6P4C); Other: removable screw terminal blocks	
Maximum Humidity	90% non-condensing	
Operating Temperature	0-55 °C (32-158 °F) (mount to suitable heat sink)	
Drive Cooling Method	natural convection (mount to suitable heat sink)	
Mounting	#6 mounting screws (mount to suitable heat sink)	
Dimensions	3.0 x 3.65 x 1.125 inches [76.2 x 92.7 x 28.6 mm]	
Weight	8 oz [227g] (approximate)	
Agency Approvals	CE, RoHS	

SureStep™ System Recommended Component Compatibility			
Drives (1)	Power Supplies (1)		Motors & Extension Cables (2,3)
STP-DRV-4035	-	-	STP-MTR-xxxxx & STP-EXT-020 STP-MTRH-xxxxx & STP-EXTH-020
STP-DRV-4850	-	STP-PWR-4805	
STP-DRV-80100	STP-PWR-7005	STP-PWR-4810	

1) **Caution: Do not use a power supply that exceeds the drive input voltage range. Using a lower voltage power supply with a higher voltage drive is acceptable, but will not provide full system performance.**

2) **MTR motors have connectors compatible with the EXT extension cables.**

3) **MTRH motors have connectors compatible with the EXTH extension cables.**

Connecting the Power Supply

An STP-PWR-xxxx series power supply from AUTOMATIONDIRECT is the best choice to power the step motor drive.

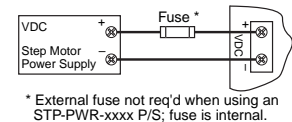

If the power supply you choose does not have a fuse on the output, you will need to install a fuse on the “+” power supply lead.

WARNING: Be careful not to reverse the polarity from the power supply to the drive. Reverse connection will destroy your drive and void the warranty.

Connecting the Motor

WARNING: When connecting a step motor to the STP-DRV-xxxx drive, be sure that the motor power supply is switched off. When using a motor not supplied by AUTOMATIONDIRECT, secure any unused motor leads so that they can't short circuit. Never disconnect the motor while the drive is powered up. Never connect the motor leads to ground or directly to the power supply. (See the Typical Wiring Diagram on this data sheet for the step motor lead color code of AUTOMATIONDIRECT supplied motors.)

Connecting the Logic

The logic inputs are optically isolated to reduce electrical noise problems. The logic inputs require DC power from a source that is different from the one used to power the step motor power circuits.

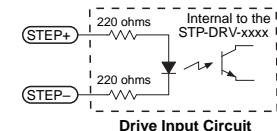

If bidirectional rotation is required, supply a source of step pulses to the drive at the STEP+ and STEP- terminals, and a direction signal at the DIR+ and DIR- terminals.

The ENABLE input allows the logic to turn off the current to the step motor by providing a signal to the EN+ and EN- terminals. If you do not need to disable the output to the step motor, just leave the EN+ and EN- terminals disconnected.

All logic inputs can be controlled by a DC output signal that is either sinking (NPN), sourcing (PNP), or differential.

Examples for connecting various forms of outputs from both indexers and PLCs are shown on this data sheet.

SureStep™ STEPPING SYSTEMS

Advanced Microstepping Drives STP-DRV-4850 & STP-DRV-80100

Typical Wiring Diagram

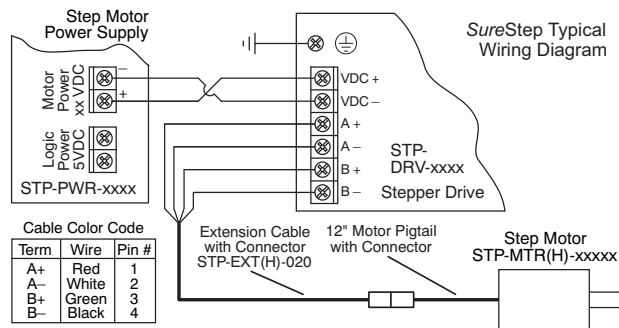

Connecting to an Indexer with Sinking Outputs

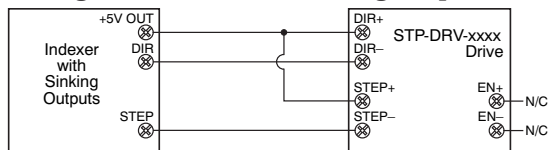

Connecting to an Indexer with Sourcing Outputs

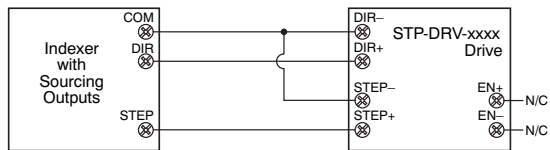

Connecting to an Indexer with Differential Outputs

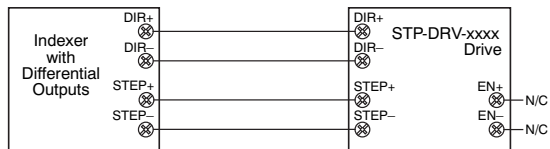

Using Logic That is Not 5 Volt TTL Level

Some step and direction signals, especially those of some PLCs, do not use 5 volt logic. In these cases, a signal as high as 24 VDC can be used with the step motor drive by adding an external dropping resistor to the STEP, DIR and EN input logic terminals.

For 12 VDC logic, add an 820 Ohm, 1/4 Watt resistor.

For 24 VDC logic, add a 2200 Ohm, 1/4 Watt resistor.

Indexer with 12-24 VDC Sink or Source Outputs

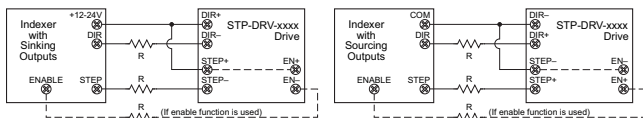

PLC with 12-24 VDC Sink or Source Outputs

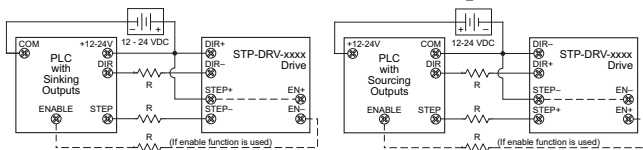

Connecting to EN Inputs with Relay or Switch

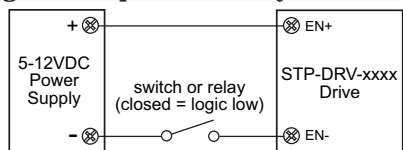

Connecting to EN Inputs with NPN Proximity Sensor

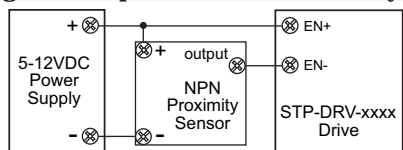

Connecting to EN Inputs with PNP Proximity Sensor

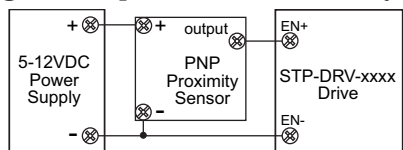

Mounting the Drive

You can mount your drive on the wide or the narrow side of the chassis using #6 screws. If possible, the drive should be securely fastened to a smooth, flat metal surface that will help conduct heat away from the chassis. If this is not possible, then forced airflow from a fan may be required to prevent the drive from overheating.

- Never use your drive in a space where there is no air flow or where the ambient temperature exceeds 40 °C (104 °F).
- When mounting multiple STP-DRV-xxxx drives near each other, maintain at least one half inch of space between drives.
- Never put the drive where it can get wet.
- Never allow metal or otherwise conductive particles near the drive.

SureStep™ Pro Drive Configuration Software

The SureStep advanced drives STP-DRV-4850 & -80100 are configured using SureStep Pro configuration software, which is included on CD with the drive.

- Used for easy configuration and setup of the drive, including drive, motion control mode, I/O, motor.
- Serial command language for motor drive control via serial port; eliminates the need for separate motion controllers or indexers; provides easy interface to other industrial devices such as PCs, PLCs and HMIs.
- Help files include technical data, application information, advanced setup, serial command instructions.
- Runs on Windows Vista, XP, 2000, NT, ME, 98.



SureStep™ Advanced Drive Quick Setup

More complete instruction details are available elsewhere on this Data Sheet, and in the SureStep User Manual (available online from AutomationDirect.com).

- 1) Install the SureStep Pro software onto a computer from the CD.
- 2) Launch the software by clicking: Start / Programs / SureStepPro / SureStepPro.
- 3) Connect your PC to the drive using the supplied programming cable (part # STP-232RJ11-CBL).
- 4) Wire the drive to the DC power source (fusing may be required).
- 5) Provide a proper ground connection for the drive by using the screw on the left side of drive chassis.
- 6) Connect the drive to the motor.
- 7) Apply power to the drive.
- 8) Follow the instructions in the SureStep Pro software help screens to set up and configure the drive.