

# DL05 I/O Specifications

**D0-05DA**      **\$220.00**

*Wiring diagram and specifications*

D0-05DA Specifications		
<b>AC Power Supply Specifications</b>	<b>Voltage Range</b>	<b>95-240 VAC (30VA)</b>
<b>DC Input Specifications</b>	<b>Number of Input Pts.</b>	8 (sink/source)
	<b>Number of Commons</b>	2 (isolated)
	<b>Input Voltage Range</b>	12-24 VDC
	<b>Input Impedance</b>	(X0-X2) 1.8K @ 12-24 VDC (X3-X7) 2.8K @ 12-24 VDC
	<b>Frequency Range</b>	47-63 Hz
	<b>Input Current</b>	8mA @ 100VAC at 50Hz 10mA @ 100VAC at 60Hz
	<b>On Current/Voltage Level</b>	>5mA/10VDC
	<b>OFF Current/Voltage Level</b>	<0.5 mA/<2VDC
	<b>Response Time</b>	X0-X2    X3-X7
	<b>OFF to ON Response</b>	<100µs   <8ms
	<b>ON to OFF Response</b>	<100µs   <8ms
<b>Fuses</b>	None	
<b>AC Output Specifications</b>	<b>Number of Output Points</b>	6
	<b>Number of Commons</b>	2 (isolated)
	<b>Output Voltage Range</b>	17-240 VAC 47-63 Hz
	<b>Peak Voltage</b>	264VAC
	<b>ON Voltage Drop</b>	1.5 VAC >50mA 4.0 VAC <50mA
	<b>Maximum Current</b>	0.5 A / point
	<b>Maximum Leakage Current</b>	4mA @ 264VAC
	<b>Maximum Inrush Current</b>	10A for 10ms
	<b>Minimum Load</b>	10mA
	<b>OFF to ON Response</b>	1ms
	<b>ON to OFF Response</b>	1ms + 1/2 cycle
<b>Fuses</b>	None (external recommended)	

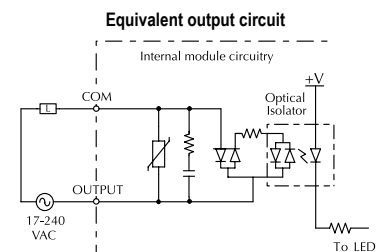
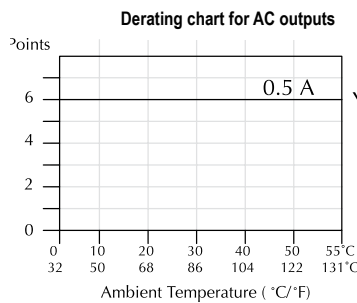
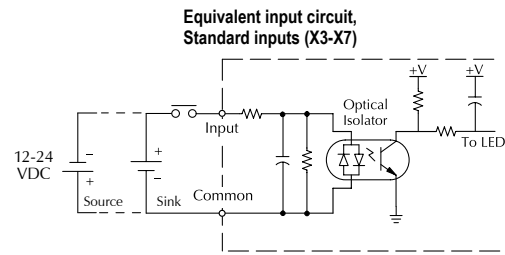
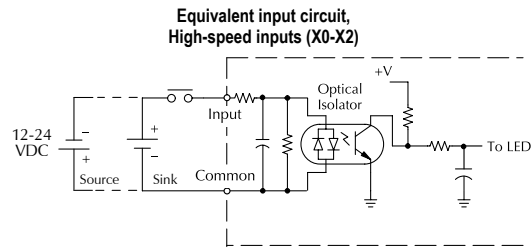
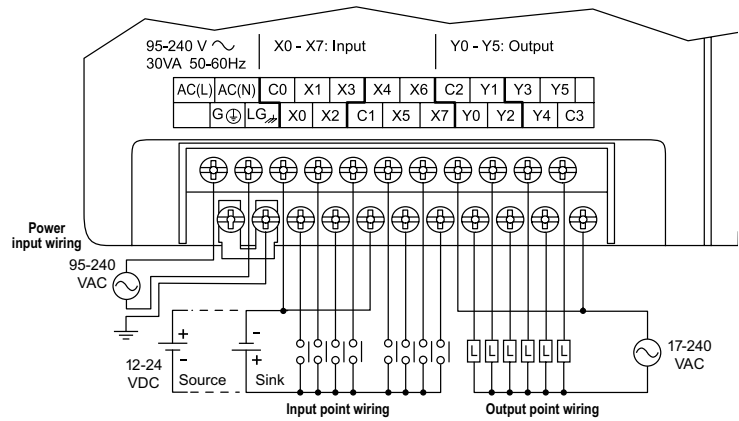

# Features at a Glance

The DL05 and DL06 micro PLCs are complete self-contained systems. The CPU, power supply, and I/O are all included inside the same housing. Option modules are available to expand the capability of each PLC family for more demanding applications. The standard features of these PLCs are extraordinary and compare favorably with larger and more expensive PLCs.

The specification tables to the right are meant for quick reference only. Detailed specifications and wiring information for each model of the DL05 and DL06 PLCs can be found in those specific sections.

## Program capacity

Most boolean ladder instructions require a single word of program memory. Other instructions, such as timers, counters, etc., require two or more words. Data is stored in V-memory in 16-bit registers.

### Performance

The performance characteristics shown in the tables represent the amount of time required to read the inputs, solve the Relay Ladder Logic program and update the outputs.

### Instructions

A complete list of instructions is available at the end of this section.

### Communications

The DL05 and DL06 offer powerful communication features normally found only on more expensive PLCs.

### Special features

The DC input and DC output PLCs offer high-speed counting or pulse output. Option module slots allow for discrete I/O expansion, analog I/O, or additional communication options.

DL05 CPU Specifications	
<b>System capacity</b>	
Total memory available (words).....	6K
Ladder memory (words).....	2048
V-memory (words).....	4096
User V-memory.....	3968
Non-volatile user V-memory.....	128
Battery backup.....	Yes1
Total built-in I/O.....	14
Inputs.....	8
Outputs.....	6
I/O expansion.....	Yes1
<b>Performance</b>	
Contact execution (Boolean).....	0.7 µs
Typical scan (1K Boolean) <sup>2</sup> .....	1.5-3 ms.
<b>Instructions and diagnostics</b>	
RLL ladder style.....	Yes
RLLPLUS/flowchart style (Stages).....	Yes/256
Run-time editing.....	Yes
Supports Overrides.....	Yes
Scan.....	Variable/fixed
<b>Number of Instructions</b> .....	133
<b>Types of Instructions:</b>	
Control relays.....	512
Timers.....	128
Counters.....	128
Immediate I/O.....	Yes
Subroutines.....	Yes
For/next loops.....	Yes
Timed interrupt.....	Yes
Integer math.....	Yes
Floating-point math.....	No
PID.....	Yes
Drum sequencers.....	Yes
Bit of word.....	Yes
ASCII print.....	Yes
Real-time clock/calendar.....	Yes <sup>1</sup>
Internal diagnostics.....	Yes
Password security.....	Yes
System and user error log.....	No
<b>Communications</b>	
Built-in ports.....	Two RS-232C
<b>Protocols supported:</b>	
K-sequence (proprietary protocol).....	Yes
DirectNet Client/Server.....	Yes
Modbus RTU Client/Server.....	Yes
ASCII out.....	Yes
Baud rate.....	
Port 1.....	9,600 baud (fixed)
Port 2.....	selectable 300-38,400 baud (default 9,600)
<b>Specialty Features</b>	
Filtered inputs.....	Yes <sup>3</sup>
Interrupt input.....	Yes <sup>3</sup>
High speed counter.....	Yes, 5kHz <sup>2</sup>
Pulse output.....	Yes, 7kHz <sup>2</sup>
Pulse catch input.....	Yes <sup>3</sup>
<ol style="list-style-type: none"> <li>1- These features are available with use of certain option modules. Option module specifications are located later in this section.</li> <li>2- Our 1K program includes contacts, coils, and scan overhead. If you compare our products to others, make sure you include their scan overhead.</li> <li>3- Input features only available on units with DC inputs and output features only available on units with DC outputs.</li> </ol>	

DL06 CPU Specifications	
<b>System capacity</b>	
Total memory available (words).....	14.8K
Ladder memory (words).....	7680
V-memory (words).....	7616
User V-memory.....	7488
Non-volatile user V-memory.....	128
Built-in battery backup (D2-BAT-1).....	Yes
Total I/O.....	36
Inputs.....	20
Outputs.....	16
I/O expansion.....	Yes <sup>1</sup>
<b>Performance</b>	
Contact execution (Boolean).....	0.6 µs
Typical scan (1K Boolean) <sup>2</sup> .....	1-2 ms.
<b>Instructions and diagnostics</b>	
RLL ladder style.....	Yes
RLLPLUS/flowchart style (Stages).....	Yes/1024
Run-time editing.....	Yes
Supports Overrides.....	Yes
Scan.....	Variable/fixed
<b>Number of Instructions</b> .....	229
<b>Types of Instructions:</b>	
Control relays.....	1024
Timers.....	256
Counters.....	128
Immediate I/O.....	Yes
Subroutines.....	Yes
For/next loops.....	Yes
Table functions.....	Yes
Timed interrupt.....	Yes
Integer math.....	Yes
Trigonometric functions.....	Yes
Floating-point math.....	Yes
PID.....	Yes
Drum sequencers.....	Yes
Bit of word.....	Yes
Number type conversion.....	Yes
ASCII in, out, print.....	Yes
LCD instruction.....	Yes
Real-time clock/calendar.....	Yes
Internal diagnostics.....	Yes
Password security.....	Yes
System and user error log.....	No
<b>Communications</b>	
Built-in ports:	
One RS-232C	
One multi-function RS232C/RS422/RS485	
<b>NOTE: RS485 is for MODBUS RTU only.</b>	
<b>Protocols supported:</b>	
K-sequence (proprietary protocol).....	Yes
DirectNet Client/Server.....	Yes
Modbus RTU Client/Server.....	Yes
ASCII in/out.....	Yes
Baud rate.....	
Port 1.....	600 baud (fixed)
Port 2.....	selectable 300-38,400 baud (default 9,600)
<b>Specialty Features</b>	
Filtered inputs.....	Yes <sup>3</sup>
Interrupt input.....	Yes <sup>3</sup>
High speed counter.....	Yes, 7kHz <sup>3</sup>
Pulse output.....	Yes, 10kHz <sup>3</sup>
Pulse catch input.....	Yes <sup>3</sup>
<ol style="list-style-type: none"> <li>1- These features are available with use of certain option module. Option module specifications are located later in this section.</li> <li>2- Our 1K program includes contacts, coils, and scan overhead. If you compare our products to others, make sure you include their scan overhead.</li> <li>3- Input features only available on units with DC inputs and output features only available on units with DC outputs.</li> </ol>	

# Features at a Glance

## DirectSOFT software

The DL05 and DL06 PLCs use the same familiar DirectSOFT programming software that our larger PLCs use. A FREE version of DirectSOFT gives you all the great features of the full version, but with a 100-word PLC program download limitation. For programs larger than 100 words, the full package is required. The FREE PC-DS100 software may be sufficient to program the DL05 and DL06. If you are programming with a full package version prior to v6.0, you will need v2.4 or later for the DL05 PLCs and v4.0 or later for the DL06. We always recommend the latest version for the most robust features. See the DirectLOGIC Overview section DL in this catalog for a complete description of DirectSOFT including features, part numbers of programming packages and upgrades.

### Programming

Handheld programmer...D2-HPP \$590.00

DirectSOFT Programming for Windows

PC-DSOFT6 \$462.00

PC-DS100 Free

PC-R60-U (upgrade) \$291.00

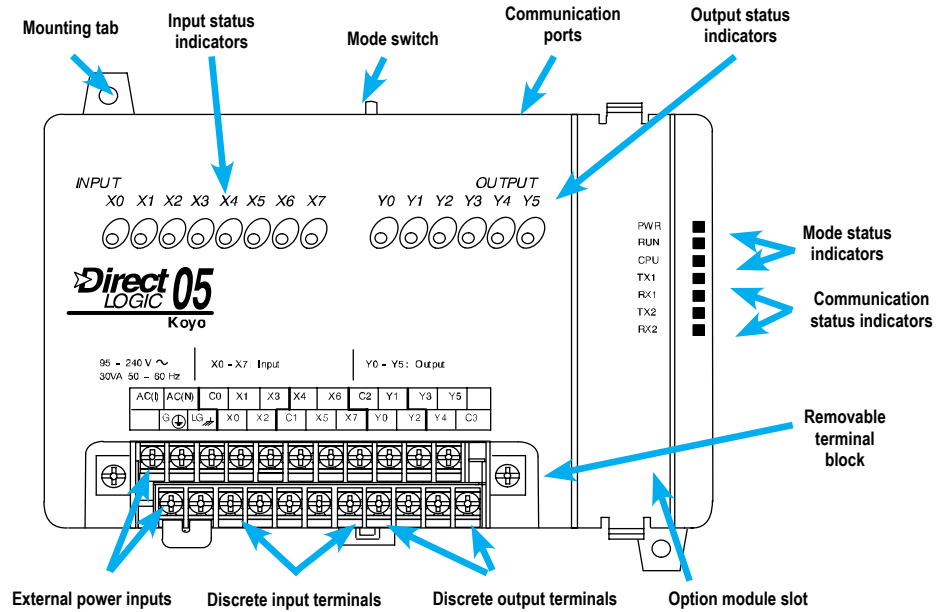

## Hardware features diagrams



# Product Dimensions and Installation

It is important to understand the installation requirements for your DL05 or DL06 system. Your knowledge of these requirements will help ensure that your system operates within its environmental and electrical limits.

## Plan for safety

This catalog should never be used as a replacement for the user manual. You can purchase, download free, or view online the user manuals for these products. The [D0-USER-M](#) is the publication for the DL05 PLCs, and the [D0-06USER-M](#) is the publication for the DL06 PLCs. The [D0-OPTIONS-M](#) is the user manual for the option modules. These user manuals contain important safety information that must be followed. The system installation should comply with all appropriate electrical codes and standards.

## Unit dimensions and

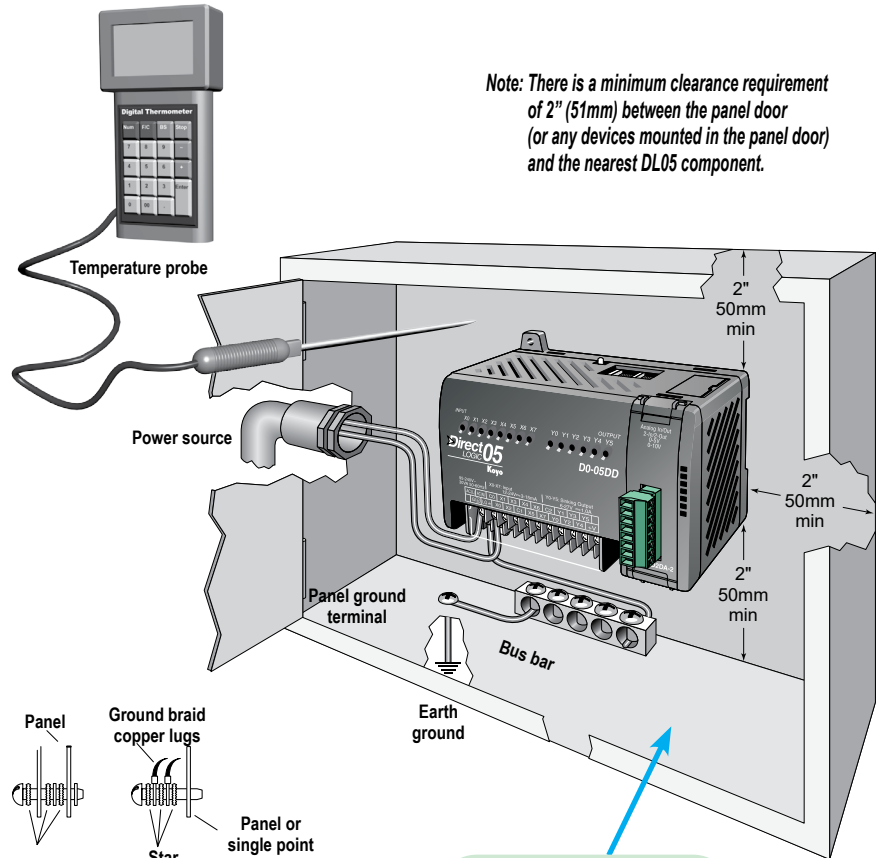

*Note: There is a minimum clearance requirement of 2" (51mm) between the panel door (or any devices mounted in the panel door) and the nearest DL05 component.*



**See the Enclosure section to find an enclosure that fits your application**

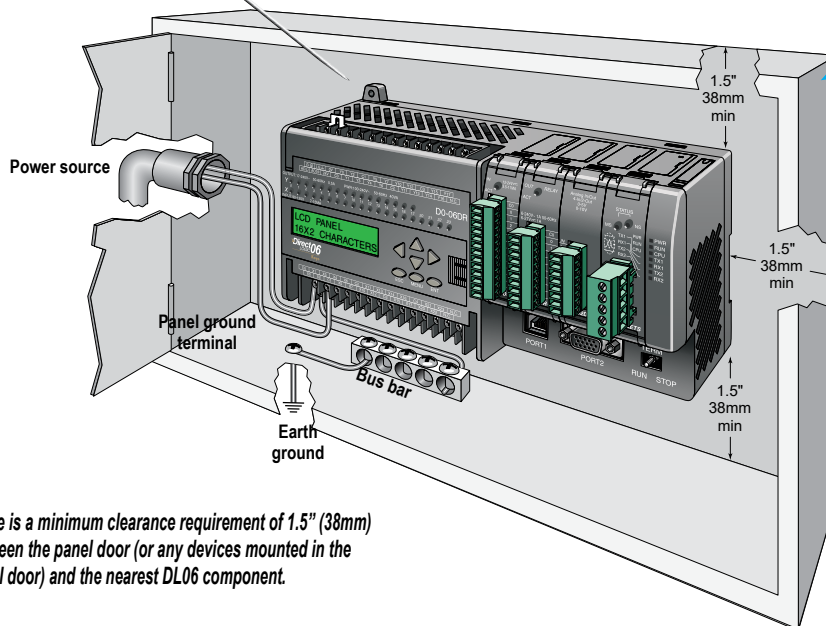

*Note: There is a minimum clearance requirement of 1.5" (38mm) between the panel door (or any devices mounted in the panel door) and the nearest DL06 component.*

Environmental Specifications for DL05 and DL06	
<b>Storage Temperature</b>	-4° F-158°F (-20°C to 70°C)
<b>Ambient Operating Temperature</b>	32°F-131°F (0° to 55°C)
<b>Ambient Humidity</b>	5 to 95% relative humidity (non-condensing)
<b>Vibration Resistance</b>	MIL STD 810C Method 514.2
<b>Shock Resistance</b>	MIL STD 810C Method 516.2
<b>Noise Immunity</b>	NEMA (ICS3-304)
<b>Atmosphere</b>	No corrosive gases

# Product Dimensions and Installation

## Mounting Orientation

DL05 and DL06 PLCs must be mounted properly to ensure ample airflow for cooling purposes. It is important to follow the unit orientation requirements and to verify that the PLC's dimensions are compatible with your application. Notice particularly the grounding requirements and the recommended cabinet clearances.

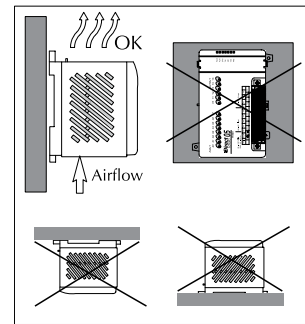
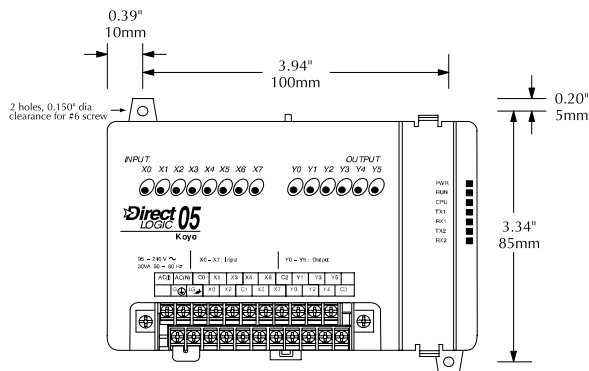

Mounting orientation

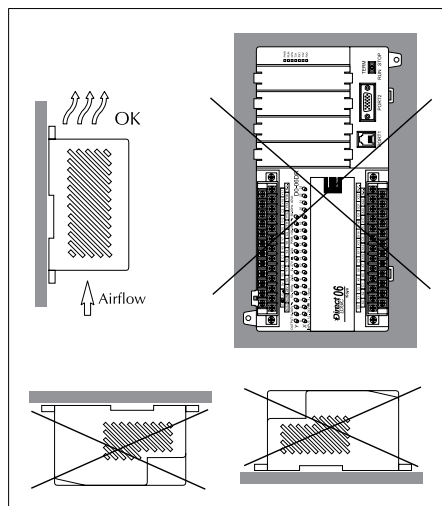

Mounting orientation

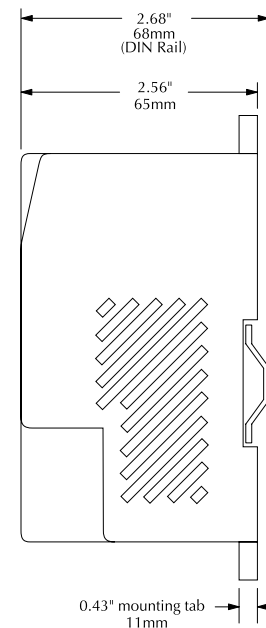
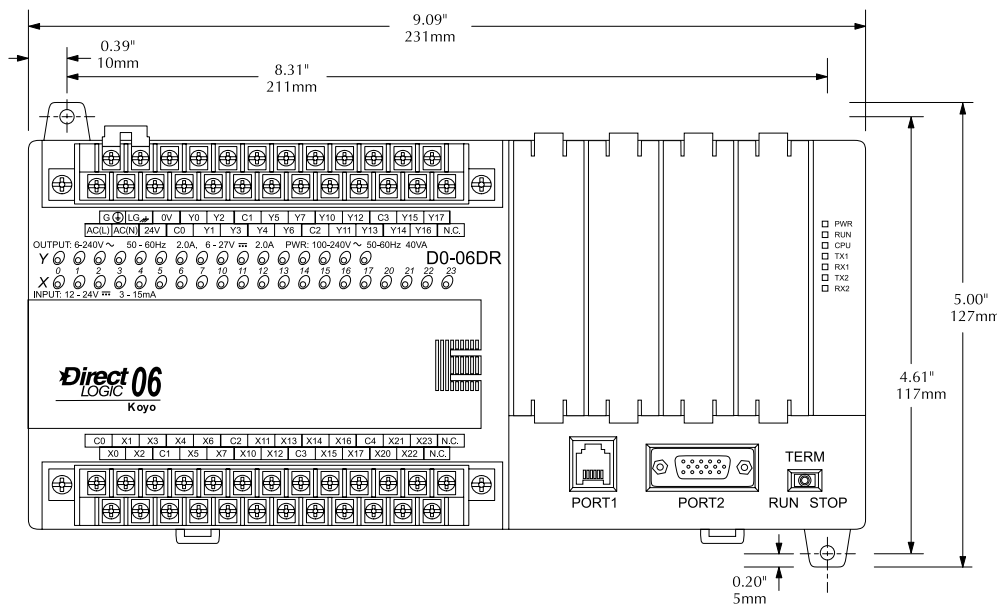
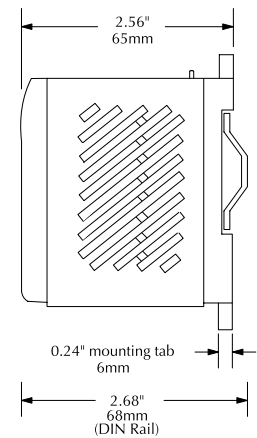
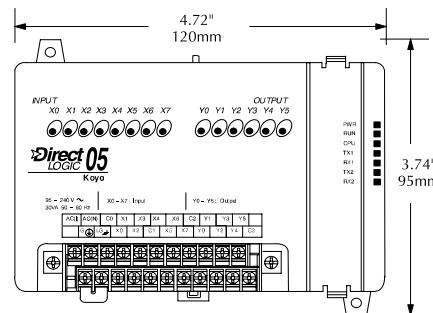

# Ports, Status Indicators, and Modes

## Port 1

Port 1 is a 6-pin, fixed configuration port and has the same pin assignments on the DL05 and the DL06. Please refer to the table and diagrams on this page. This port can be used to connect to an HPP, DirectSOFT, an operator interface, or other external device. Features include:

- 9600 baud
- 8 data bits
- Odd parity
- 1 start bit, 1 stop bit
- Station address of 1
- Asynchronous, half-duplex, DTE

Protocols supported (as Server):

- K sequence, **DirectNET**, Modbus RTU

DL05 & DL06 Port 1 Pin Descriptions		
1	0V	Power (-) connection (GND)
2	5V	Power (+) connection
3	RXD	Receive data (RS-232C)
4	TXD	Transmit data (RS-232C)
5	5V	Power (+) connection
6	0V	Power (-) connection (GND)

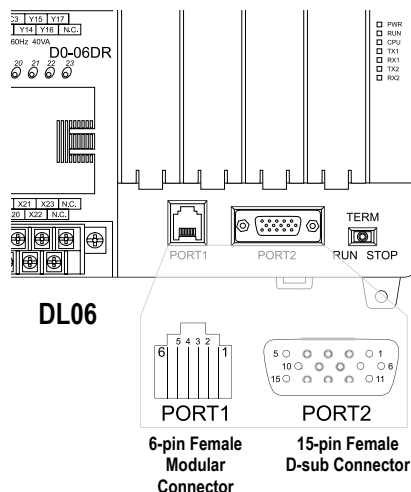
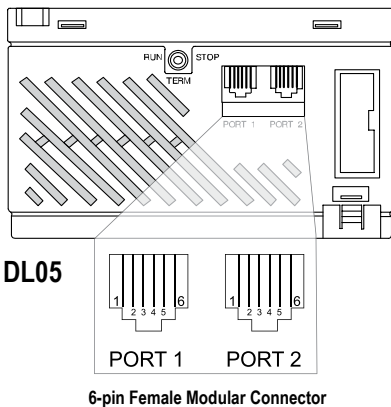

## Port 2

Port 2 is a configurable port on both the DL05 and the DL06 PLCs. The DL05 PLC uses a 6-pin modular connector and offers RS-232 communications and offers RS-232 communications only. The DL06 PLC uses a 15-pin HD-sub connector and offers RS-232, RS-422, or RS-485 communications. Please refer to the table and diagrams on this page for more information. This port can be used to connect to an HPP, DirectSOFT, an operator interface, or other external device. Features of port 2 include:

- 300, 600, 1200, 2400, 4800, 9600 (default), 19,200, 38,400 baud
  - 8 data bits
  - Odd (default), even, or no parity
  - 1 start bit, 1 stop bit
  - Station address:
    - 1 (default)
    - 1-90 DirectNET, K sequence
    - 1-247 Modbus RTU
  - Asynchronous, half-duplex, DTE
- Protocols supported:
- K sequence (Server), **DirectNET** (Client/Server), Modbus (Client/Server)

DL05 Port 2 Pin Descriptions		
1	0V	Power (-) connection (GND)
2	5V	Power (+) connection
3	RXD	Receive data (RS-232C)
4	TXD	Transmit data (RS-232C)
5	RTS	Ready to send
6	0V	Power (-) connection (GND)

DL06 Port 2 Pin Descriptions		
1	5V	Power (+) connection
2	TXD	Transmit data (RS-232C)
3	RXD	Receive data (RS-232C)
4	RTS	Ready to send (RS232C)
5	CTS	Clear to send (RS232C)
6	RXD-	Receive data (-) (RS-422/485)
7	0V	Power (-) connection (GND)
8	0V	Power (-) connection (GND)
9	TXD+	Transmit data (+) (RS-422/485)
10	TXD-	Transmit data (-) (RS-422/485)
11	RTS+	Ready to send (+) (RS-422/485)
12	RTS-	Ready to send (-) (RS-422/485)
13	RXD+	Receive data (+) (RS-422/485)
14	CTS+	Clear to send (+) (RS-422/485)
15	CTS-	Clear to send (-) (RS-422/485)

## DL05 and DL06 status indicators

Status Indicators		
Indicator	Status	Meaning
<b>PWR</b>	ON	Power good
	OFF	Power failure
<b>RUN</b>	ON	CPU is in Run Mode
	OFF	CPU is in Stop or Program Mode
<b>CPU</b>	ON	CPU self diagnostics error
	OFF	CPU self diagnostics good
<b>TX1</b>	ON	Data is being transmitted by the CPU-Port 1
	OFF	No data is being transmitted by the CPU-Port 1
<b>RX1</b>	ON	Data is being received by the CPU-Port 1
	OFF	No data is being received by the CPU-Port 1
<b>TX2</b>	ON	Data is being transmitted by the CPU-Port 2
	OFF	No data is being transmitted by the CPU-Port 2
<b>RX2</b>	ON	Data is being received by the CPU-Port 2
	OFF	No data is being received by the CPU-Port 2

## DL05 and DL06 mode switches

Mode Switch Position	CPU Action
<b>RUN (Run Program)</b>	CPU is forced into the RUN mode if no errors are encountered. No program changes are allowed by the programming/monitoring device.
<b>TERM (Terminal)</b>	RUN PROGRAM and the TEST modes are available. Mode and program changes are allowed by the programming/monitoring device.
<b>STOP</b>	CPU is forced into the STOP mode. No changes are allowed by the programming/monitoring device.

Use the optional low profile 15-pin adapter to make option module wiring easier.



DL05 / DL06 PLCs

tDL5-10