

# DL05 I/O Specifications

D0-05DR



## Wiring diagram and specifications

D0-05DR Specifications		
<b>AC Power Supply Specifications</b>	<b>Voltage Range</b>	95-240VAC (30VA)
	<b>Number of Input Pts.</b>	8 (sink/source)
	<b>Number of Commons</b>	2 (isolated)
	<b>Input Voltage Range</b>	12-24VDC
	<b>Input Impedance</b>	(X0-X2) 1.8K @ 12-24VDC (X3-X7) 2.8K @ 12-24VDC
	<b>On Current/Voltage Level</b>	>5mA/10VDC
	<b>OFF Current/Voltage Level</b>	<0.5mA/<2VDC
	<b>Response Time</b>	X0-X2   X3-X7
	<b>OFF to ON Response</b>	<100µs   <8ms
	<b>ON to OFF Response</b>	<100µs   <8ms
<b>DC Input Specifications</b>	<b>Fuses</b>	None
	<b>Number of Output Points</b>	6
	<b>Number of Commons</b>	2 (isolated)
	<b>Output Voltage Range</b>	6-240VAC, 47-63Hz 6-27VDC
	<b>Maximum Voltage</b>	264VAC, 30VDC
	<b>Maximum Current</b>	2A/point 6A/common
	<b>Maximum Leakage Current</b>	0.1mA @ 246VAC
	<b>Smallest Recommended Load</b>	5mA @ 5VDC
	<b>OFF to ON Response</b>	<15ms
	<b>ON to OFF Response</b>	<10ms
	<b>Status Indicators</b>	Logic side
	<b>Fuses</b>	None (external recommended)

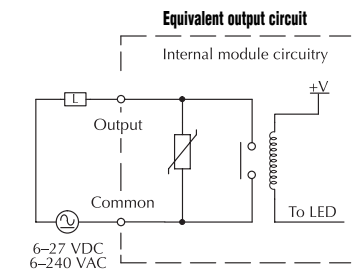
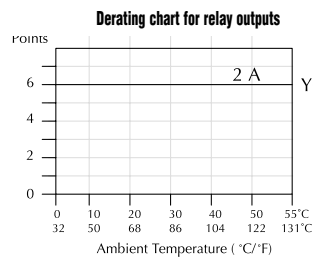
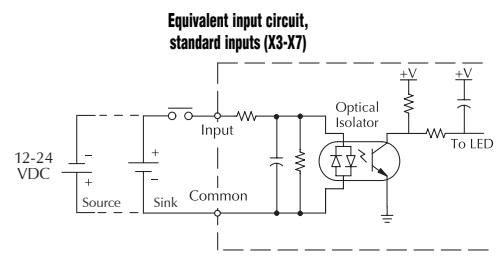
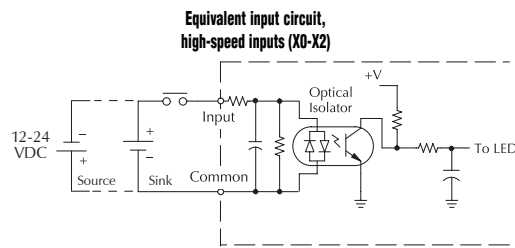
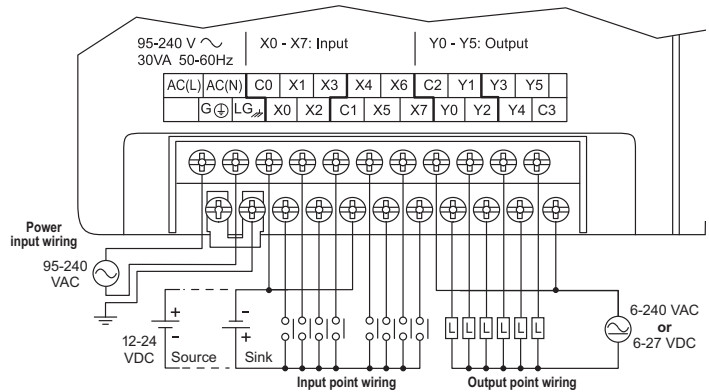

Typical Relay Life (Operations) at Room Temperature		
Voltage and Type of Load	Load Current	
	1A	2A
24 VDC Resistive	600K	270K
24 VDC Solenoid	150K	60K
110 VAC Resistive	900K	350K
110 VAC Solenoid	350K	150K
220 VAC Resistive	600K	250K
220 VAC Solenoid	200K	100K

# Features at a Glance

The DL05 and DL06 micro PLCs are complete self-contained systems. The CPU, power supply, and I/O are all included inside the same housing. Option modules are available to expand the capability of each PLC family for more demanding applications. The standard features of these PLCs are extraordinary and compare favorably with larger and more expensive PLCs.

The specification tables to the right are meant for quick reference only. Detailed specifications and wiring information for each model of the DL05 and DL06 PLCs can be found in those specific sections.

## Program capacity

Most boolean ladder instructions require a single word of program memory. Other instructions, such as timers, counters, etc., require two or more words. Data is stored in V-memory in 16-bit registers.

## Performance

The performance characteristics shown in the tables represent the amount of time required to read the inputs, solve the Relay Ladder Logic program and update the outputs.

## Instructions

A complete list of instructions is available at the end of this section.

## Communications

The DL05 and DL06 offer powerful communication features normally found only on more expensive PLCs.

## Special features

The DC input and DC output PLCs offer high-speed counting or pulse output. Option module slots allow for discrete I/O expansion, analog I/O, or additional communication options.

### DL05 CPU Specifications

DL05 CPU Specifications	
<b>System capacity</b>	
Total memory available (words)	6K
Ladder memory (words)	2,048
V-memory (words)	4,096
User V-memory	3,968
Non-volatile user V-memory	128
Battery backup	Yes <sup>1</sup>
Total built-in I/O	14
Inputs	8
Outputs	6
I/O expansion	Yes <sup>1</sup>
<b>Performance</b>	
Contact execution (Boolean)	0.7µs
Typical scan (1K Boolean) <sup>2</sup>	1.5-3ms
<b>Instructions and diagnostics</b>	
RLL ladder style	Yes
RLLPLUS/flowchart style (Stages)	Yes/256
Run-time editing	Yes
Supports Overrides	Yes
Scan	Variable/fixed
Number of Instructions	133
Types of Instructions:	
Control relays	512
Timers	128
Counters	128
Immediate I/O	Yes
Subroutines	Yes
For/next loops	Yes
Timed interrupt	Yes
Integer math	Yes
Floating-point math	No
PID	Yes
Drum sequencers	Yes
Bit of word	Yes
ASCII print	Yes
Real-time clock/calendar	Yes <sup>1</sup>
Internal diagnostics	Yes
Password security	Yes
System and user error log	No
<b>Communications</b>	
Built-in ports	Two RS-232C
Protocols supported:	
K-sequence (proprietary protocol)	Yes
DirectNet master/slave	Yes
Modbus RTU master/slave	Yes
ASCII out	Yes
Baud rate	
Port 1	9,600 baud (fixed)
Port 2	selectable 300-38,400 baud (default 9,600)
<b>Specialty Features</b>	
Filtered inputs	Yes <sup>3</sup>
Interrupt input	Yes <sup>3</sup>
High speed counter	Yes, 5kHz <sup>2</sup>
Pulse output	Yes, 7kHz <sup>2</sup>
Pulse catch input	Yes <sup>3</sup>
<b>1- These features are available with use of certain option modules. Option module specifications are located later in this section.</b>	
<b>2- Our 1K program includes contacts, coils, and scan overhead. If you compare our products to others, make sure you include their scan overhead.</b>	
<b>3- Input features only available on units with DC inputs and output features only available on units with DC outputs.</b>	

### DL06 CPU Specifications

DL06 CPU Specifications	
<b>System capacity</b>	
Total memory available (words)	14.8K
Ladder memory (words)	7680
V-memory (words)	7616
User V-memory	7488
Non-volatile user V-memory	128
Built-in battery backup (D2-BAT-1)	Yes
Total I/O	36
Inputs	20
Outputs	16
I/O expansion	Yes <sup>1</sup>
<b>Performance</b>	
Contact execution (Boolean)	0.6µs
Typical scan (1K Boolean) <sup>2</sup>	1-2ms
<b>Instructions and diagnostics</b>	
RLL ladder style	Yes
RLLPLUS/flowchart style (Stages)	Yes/1024
Run-time editing	Yes
Supports Overrides	Yes
Scan	Variable/fixed
Number of Instructions	229
Types of Instructions:	
Control relays	1024
Timers	256
Counters	128
Immediate I/O	Yes
Subroutines	Yes
For/next loops	Yes
Table functions	Yes
Timed interrupt	Yes
Integer math	Yes
Trigonometric functions	Yes
Floating-point math	Yes
PID	Yes
Drum sequencers	Yes
Bit of word	Yes
Number type conversion	Yes
ASCII in, out, print	Yes
LCD instruction	Yes
Real-time clock/calendar	Yes
Internal diagnostics	Yes
Password security	Yes
System and user error log	No
<b>Communications</b>	
Built-in ports:	One RS-232C
	One multi-function RS232C/RS422/RS485
<b>NOTE: RS485 is for MODBUS RTU only.</b>	
Protocols supported:	
K-sequence (proprietary protocol)	Yes
DirectNet master/slave	Yes
Modbus RTU master/slave	Yes
ASCII in/out	Yes
Baud rate	
Port 1	9,600 baud (fixed)
Port 2	selectable 300-38,400 baud (default 9,600)
<b>Specialty Features</b>	
Filtered inputs	Yes <sup>3</sup>
Interrupt input	Yes <sup>3</sup>
High speed counter	Yes, 7kHz <sup>3</sup>
Pulse output	Yes, 10kHz <sup>3</sup>
Pulse catch input	Yes <sup>3</sup>
<b>1- These features are available with use of certain option module. Option module specifications are located later in this section.</b>	
<b>2- Our 1K program includes contacts, coils, and scan overhead. If you compare our products to others, make sure you include their scan overhead.</b>	
<b>3- Input features only available on units with DC inputs and output features only available on units with DC outputs.</b>	

# Features at a Glance

## DirectSOFT software

The DL05 and DL06 PLCs use the same familiar **DirectSOFT** programming software that our larger PLCs use. A FREE version of **DirectSOFT** gives you all the great features of the full version, but with a 100-word PLC program download limitation. For programs larger than 100 words, the full package is required. The FREE PC-DS100 software may be sufficient to program the DL05 and DL06. If you are programming with a full package version prior to v5.0, you will need v2.4 or later for the DL05 PLCs and v4.0 or later for the DL06. We always recommend the latest version for the most robust features. See the Software section in this catalog for a complete description of **DirectSOFT** including features, part numbers of programming packages and upgrades.

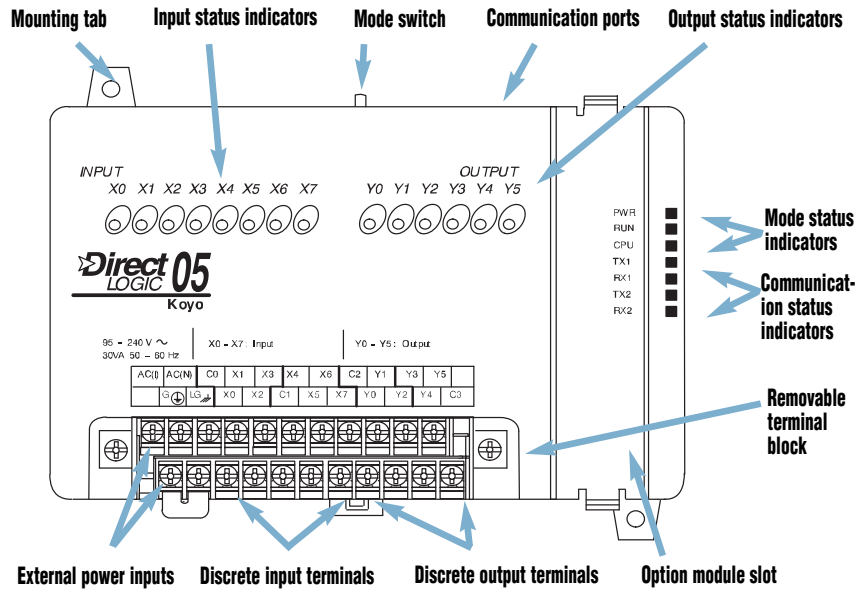

## Hardware features diagrams

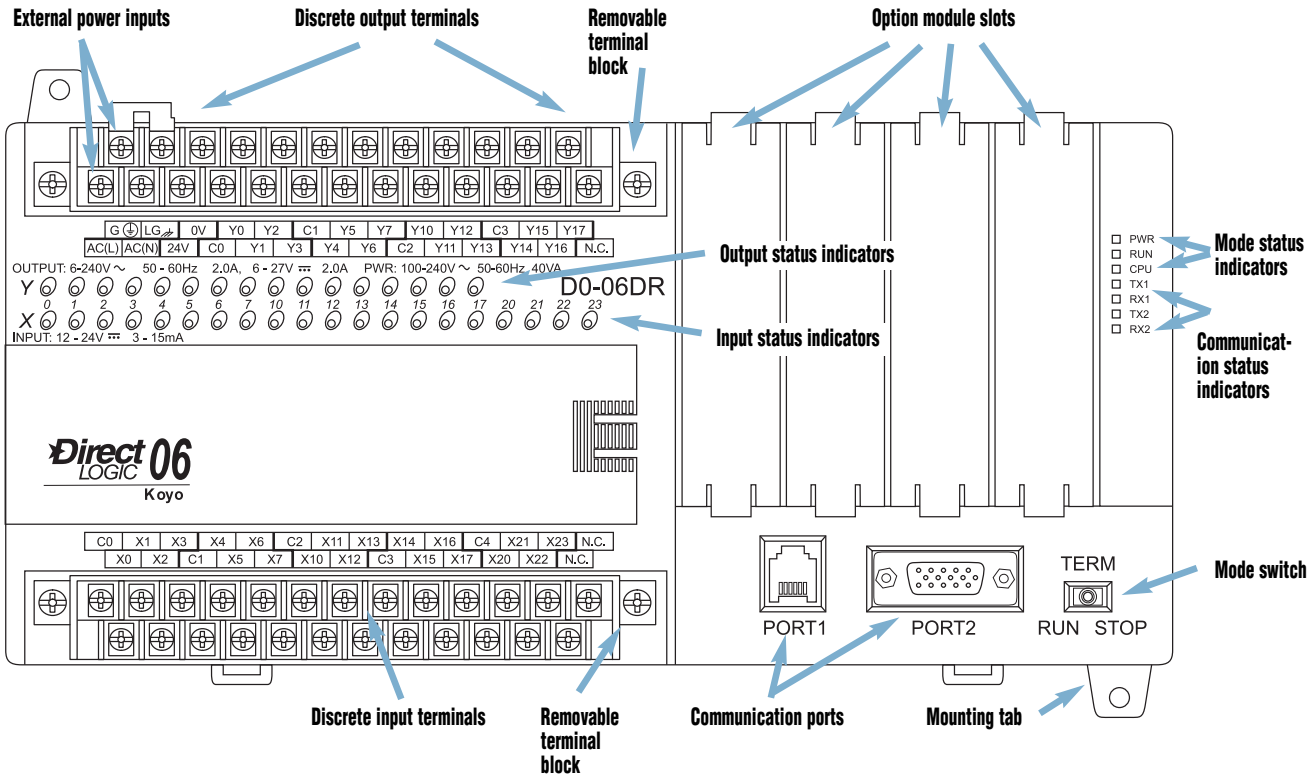

# Product Dimensions and Installation

It is important to understand the installation requirements for your DL05 or DL06 system. Your knowledge of these requirements will help ensure that your system operates within its environmental and electrical limits.

## Plan for safety

This catalog should never be used as a replacement for the user manual. You can purchase, download free, or view online the user manuals for these products. The D0-USER-M is the publication for the DL05 PLCs, and the D0-06USER-M is the publication for the DL06 PLCs. The D0-OPTIONS-M is the user manual for the option modules. These user manuals contain important safety information that must be followed. The system installation should comply with all appropriate electrical codes and standards.

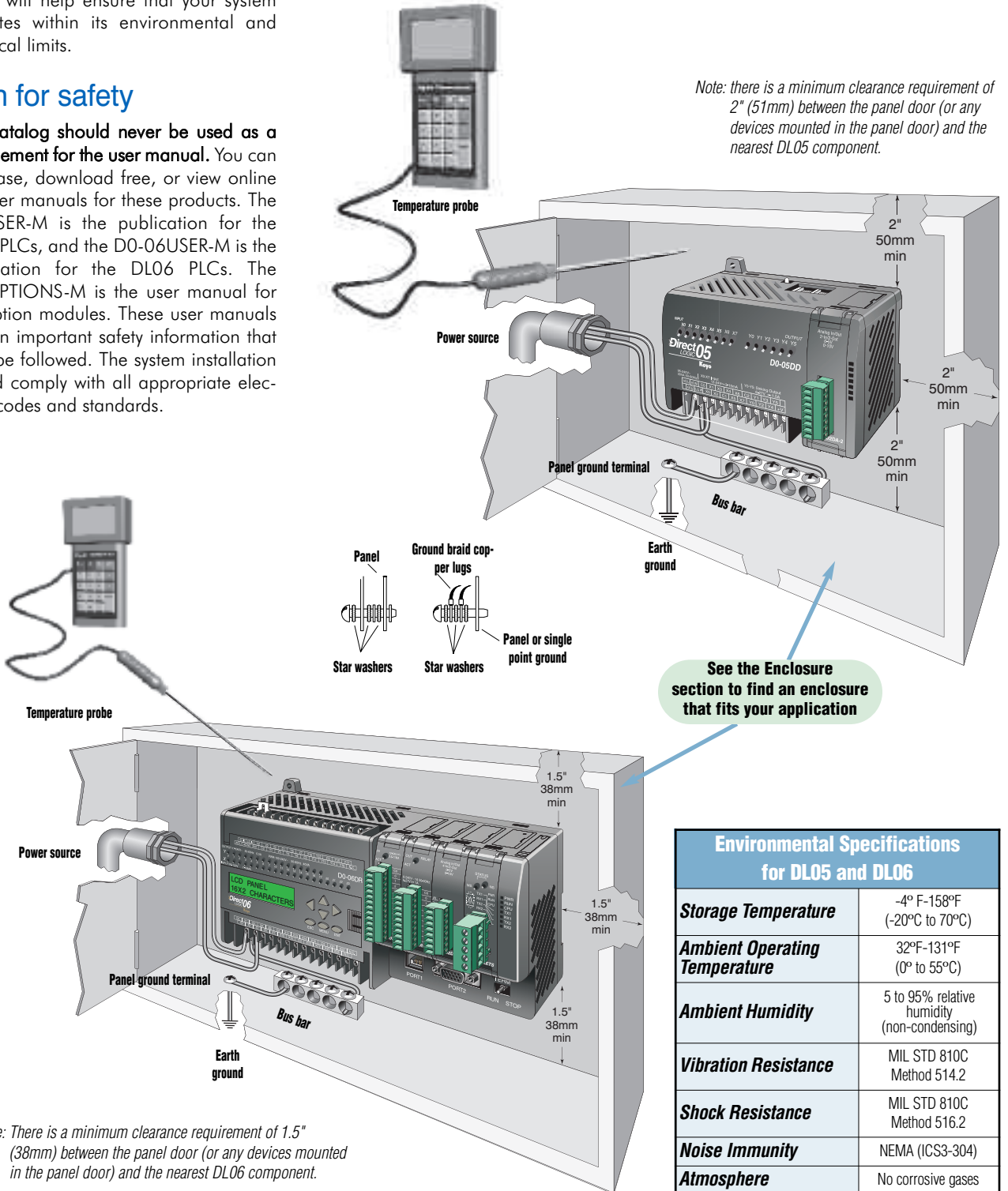



# Product Dimensions and Installation

## Unit dimensions and mounting orientation

DL05 and DL06 PLCs must be mounted properly to ensure ample airflow for cooling purposes. It is important to follow the unit orientation requirements and to verify that the PLC's dimensions are compatible with your application. Notice particularly the grounding requirements and the recommended cabinet clearances.

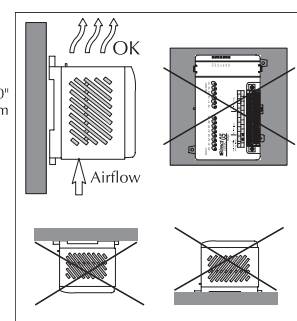
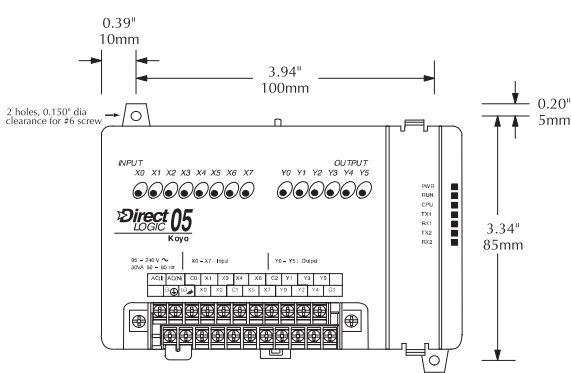

Mounting orientation

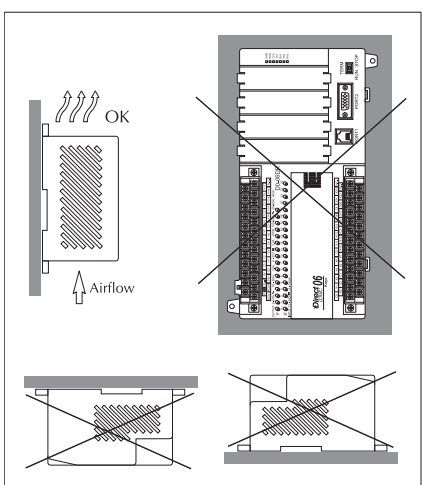

Mounting orientation

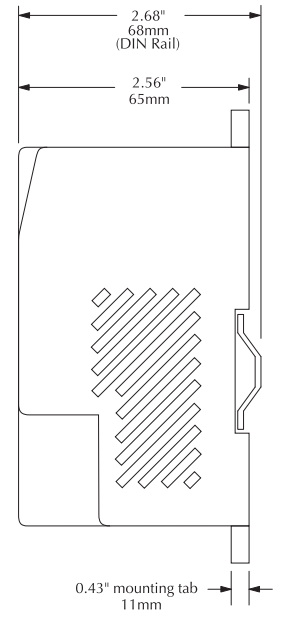
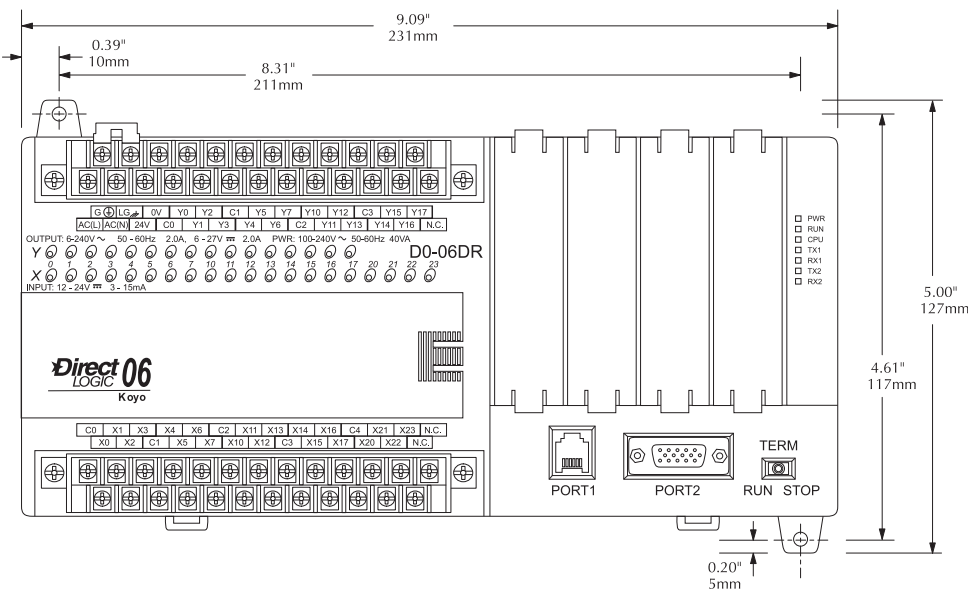
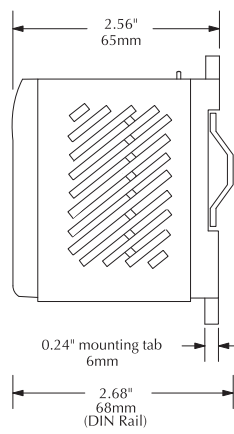
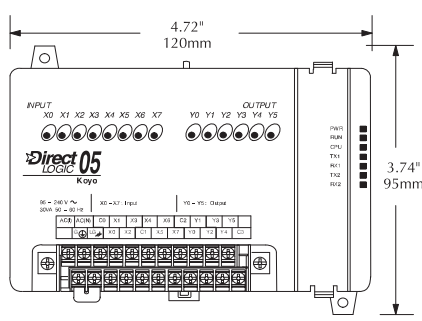



# Ports, Status Indicators, and Modes

## Port 1

Port 1 is a 6-pin, fixed configuration port and has the same pin assignments on the DL05 and the DL06. Please refer to the table and diagrams on this page. This port can be used to connect to an HPP, **DirectSOFT**, an operator interface, or other external device. Features include:

- 9600 baud
- 8 data bits
- Odd parity
- 1 start bit, 1 stop bit
- Station address of 1
- Asynchronous, half-duplex, DTE

Protocols supported (as slave):

- K sequence, **DirectNET**, Modbus RTU

DL05 & DL06 Port 1 Pin Descriptions		
1	0V	Power (-) connection (GND)
2	5V	Power (+) connection
3	RXD	Receive data (RS-232C)
4	TXD	Transmit data (RS-232C)
5	5V	Power (+) connection
6	0V	Power (-) connection (GND)

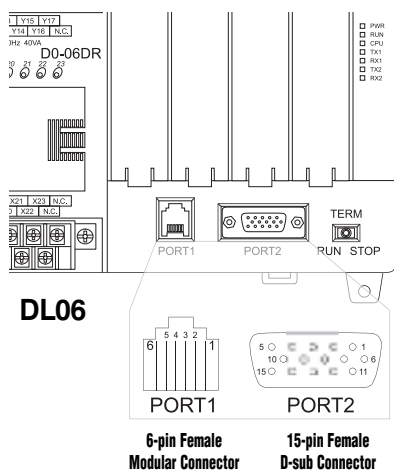
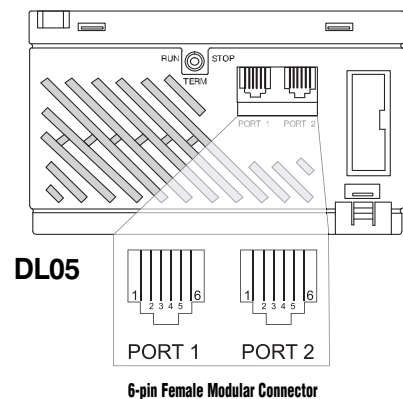

## Port 2

Port 2 is a configurable port on both the DL05 and the DL06 PLCs. The DL05 PLC uses a 6-pin modular connector and offers RS-232 communications only. The DL06 PLC uses a 15-pin HD-sub connector and offers RS-232, RS-422, or RS-485 communications. Please refer to the table and diagrams on this page for more information. This port can be used to connect to an HPP, **DirectSOFT**, an operator interface, or other external device. Features of port 2 include:

- 300, 600, 1200, 2400, 4800, 9600 (default), 19,200, 38,400 baud
- 8 data bits
- Odd (default), even, or no parity
- 1 start bit, 1 stop bit
- Station address:
  - 1 (default)
  - 1-90 **DirectNET**, K sequence
  - 1-247 Modbus RTU
- Asynchronous, half-duplex, DTE

Protocols supported:

- K sequence (slave), **DirectNET** (master/slave), Modbus (master/slave)

DL05 Port 2 Pin Descriptions		
1	0V	Power (-) connection (GND)
2	5V	Power (+) connection
3	RXD	Receive data (RS-232C)
4	TXD	Transmit data (RS-232C)
5	RTS	Ready to send
6	0V	Power (-) connection (GND)

DL06 Port 2 Pin Descriptions		
1	5V	Power (+) connection
2	TXD	Transmit data (RS-232C)
3	RXD	Receive data (RS-232C)
4	RTS	Ready to send (RS232C)
5	CTS	Clear to send (RS232C)
6	RXD-	Receive data (-) (RS-422/485)
7	0V	Power (-) connection (GND)
8	0V	Power (-) connection (GND)
9	TXD+	Transmit data (+) (RS-422/485)
10	TXD-	Transmit data (-) (RS-422/485)
11	RTS+	Ready to send (+) (RS-422/485)
12	RTS-	Ready to send (-) (RS-422/485)
13	RXD+	Receive data (+) (RS-422/485)
14	CTS+	Clear to send (+) (RS-422/485)
15	CTS-	Clear to send (-) (RS-422/485)

## DL05 and DL06 status indicators

Status Indicators		
Indicator	Status	Meaning
PWR	ON	Power good
	OFF	Power failure
RUN	ON	CPU is in Run Mode
	OFF	CPU is in Stop or Program Mode
CPU	ON	CPU self diagnostics error
	OFF	CPU self diagnostics good
TX1	ON	Data is being transmitted by the CPU-Port 1
	OFF	No data is being transmitted by the CPU-Port 1
RX1	ON	Data is being received by the CPU-Port 1
	OFF	No data is being received by the CPU-Port 1
TX2	ON	Data is being transmitted by the CPU-Port 2
	OFF	No data is being transmitted by the CPU-Port 2
RX2	ON	Data is being received by the CPU-Port 2
	OFF	No data is being received by the CPU-Port 2

## DL05 and DL06 mode switches

Mode Switch Position	CPU Action
<b>RUN (Run Program)</b>	CPU is forced into the RUN mode if no errors are encountered. No program changes are allowed by the programming/monitoring device.
<b>TERM (Terminal)</b>	RUN PROGRAM and the TEST modes are available. Mode and program changes are allowed by the programming/monitoring device.
<b>STOP</b>	CPU is forced into the STOP mode. No changes are allowed by the programming/monitoring device.

Use the optional low profile 15-pin adapter to make option module wiring easier.

