

AC Input and AC/DC Input Modules

D3-16NA AC Input <---->	
Inputs per Module	16
Commons per Module	2 (isolated)
Input Voltage Range	80-132VAC
Input Voltage Supply	External
Peak Voltage	132VAC
AC Frequency	50-60Hz
ON Voltage Level	>80 VAC
OFF Voltage Level	<15 VAC
Input Impedance	8 K ohm
Input Current	16mA @ 60Hz 24mA @ 60 Hz
Minimum ON Current	8mA
Maximum OFF Current	1.5mA
Base Power Required*	9V 6.25mA max/ON pt 100 mA max
OFF to ON Response	5-50ms
ON to OFF Response	5-60ms
Terminal Types	Removable
Status Indicators	Logic side
Weight	6.4oz. (189g)

*9V typical values are 4mA/ON pt., 64mA total

D3-08NE3 AC/DC Input <---->	
Inputs per Module	8 (sink/source)
Commons per Module	2 (isolated)
Input Voltage Range	20-28VAC/VDC
Input Voltage	External
Peak Voltage	28VAC/VDC
AC Frequency	47-63Hz
ON Voltage Level	>20V
OFF Voltage Level	<6V
Input Impedance	1.5Kohm
Input Current	19mA max
Minimum ON Current	10mA
Maximum OFF Current	2mA
Base Power Required	9V 10mA max 24V N/A
OFF to ON Response	AC: 5-50ms DC: 6-30ms
ON to OFF Response	AC/DC: 5-60ms
Terminal Type	Non-removable
Status Indicators	Field side
Weight	4.2oz. (120g)

See page 5-29 for part numbers of ZIPLink cables and connection modules compatible with this I/O module.

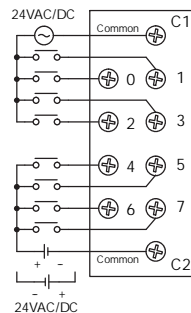
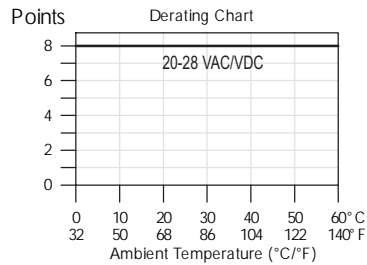
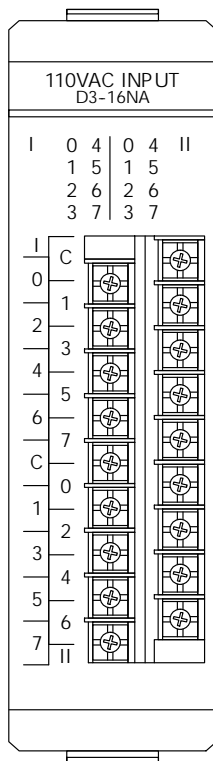
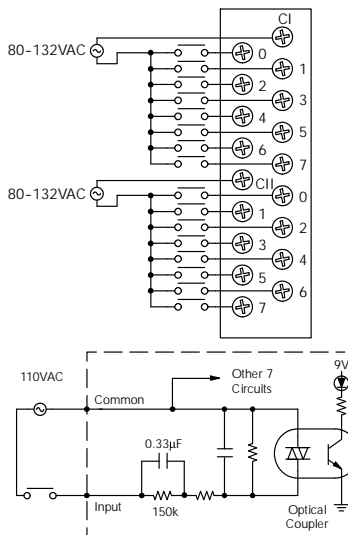
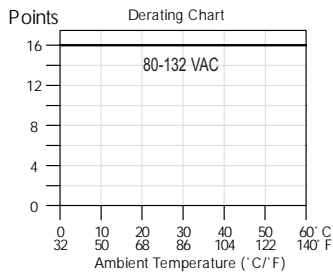

NOTE: This module can be wired in a sourcing configuration and it will be operational except there will be no module LED indication for each input.

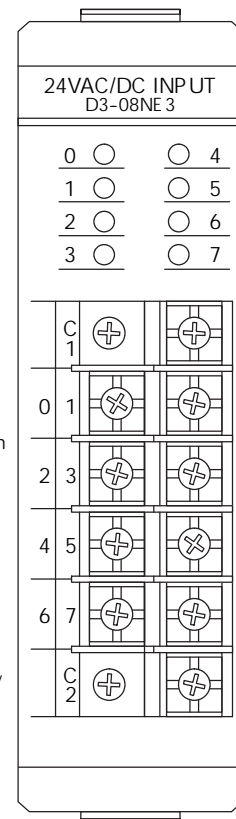
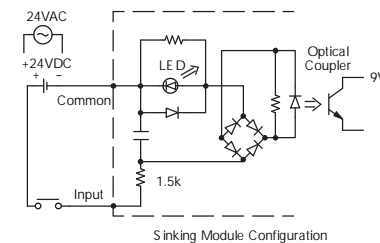

Power Budget

Managing your power resource

The I/O configuration depends on your choice of I/O modules, bases and I/O location. When determining the types and quantity of I/O modules you will be using, it's important to remember there is a limited amount of power available from the power supply.

The chart on the next page indicates the power supplied and used by each DL305 device. The adjacent chart shows an example of how to calculate the power used by your particular system. These two charts should make it easy for you to determine if the devices you have chosen fit within the power budget of your system configuration.

If the I/O you have chosen exceeds the maximum power available from the power supply, you can resolve the problem by shifting some of the modules to an expansion base.

WARNING: It is extremely important to calculate the power budget correctly. If you exceed the power budget, the system may operate in an unpredictable manner, which may result in a risk of personal injury or equipment damage.

Example: how to calculate your power usage

The following example shows how to calculate the power budget for the DL305 system. The examples are constructed around a single 5-slot base using the devices shown. It is recommended you construct a similar table for each base in your DL305 system.

1. Using a chart similar to the one below, fill in column 2.
2. Using the tables on the opposite page, enter the current supplied and used by each device (columns 3, 4, and 5). Devices which fall into the "Other" category (Row D) are devices such as the Handheld Programmer or a Data Communication Unit, which also have power requirements, but do not directly plug into the base.

3. Add the current used by the system devices (columns 3, 4, and 5), starting with Slot 1, then put the total in the row labeled "Maximum Current Required" (Row E).
4. Subtract the row labeled "Maximum Current Required" (Row E), from the row labeled "Current Supplied" (Row B). Place the difference in the row labeled "Remaining Current" (Row F).
5. If "Maximum Current Required" is greater than "Current Supplied" in columns 3, 4 or 5, the power budget will be exceeded. It will be unsafe to use this configuration and you will need to restructure your I/O configuration.

Use ZIPLinks to reduce power requirements

If your application requires a lot of relay outputs, consider using the ZipLink AC or DC relay output modules. These modules can switch high current (10A) loads without putting a load on your base power budget. Refer to the Wiring Solutions section in this catalog for more information.

This logo is placed next to I/O modules that are supported by the ZIPLink connection systems. See the I/O module specifications at the end of this section.



A	Column 1	Column 2	Column 3	Column 4	Column 5
	Base # 0	Device Type	5 VDC (mA)	9VDC (mA)	24V(mA)
B	Current Supplied				
	5-slot Base	D3-05BDC	1400	800	500
C	Current Required				
	CPU Slot	D3-330	300	50	0
	Slot 0	D3-16NE3	0	130	0
	Slot 1	D3-16NE3	0	130	0
	Slot 2	D3-08TA-1	0	160	0
	Slot 3	D3-08TA-1	0	160	0
D	Other				
		Handheld prog D3-HPP	50	50	0
E	Maximum Current Required		360	680	0
F	Remaining Current		1040	120	500

DL305 Power Requirements

This section shows the amount of power supplied by the base power supplies and the amount of power used by each DL305 device. Note the base power supplies provide three internal voltages (5V, 9V, 24V). The chart shows how much power from each of these power sources is required for each DL305 device. Use this information when calculating the power budget for your system.

In addition to the three internal power sources, the DL305 bases provide an external power connection. There is 24 VDC available from the 24 VDC output terminals on the bases (except D3-05BDC and D3-10BDC).

The 24 VDC can be used to power external devices or DL305 modules that require external 24 VDC. The power used from this external 24 VDC output reduces the internal system 24 VDC that is available to the modules by an equal amount. When using the 24 VDC output at the base terminal, it is recommended that 100 mA not be exceeded.

Power Consumed				
Device	5V(mA)	9V(mA)	24V(mA)	Ext req.
CPUs				
D3-330	300	50	0	0
D3-340	300	20	0	0
D3-350	500	0	0	0
DC Input Modules				
D3-08ND2	0	10	112	0
D3-16ND2-1	0	25	224	0
D3-16ND2F	0	25	224	0
F3-16ND3F	0	148	68	0
AC Input Modules				
D3-08NA-1	0	10	0	0
D3-08NA-2	0	10	0	0
D3-16NA	0	100	0	0
AC/DC Input Modules				
D3-08NE3	0	10	0	0
D3-16NE3	0	130	0	0
DC Output Modules				
D3-04TD1	0	12	5	0
D3-08TD1	0	20	24	0
D3-08TD2	0	30	0	0
D3-16TD1-1	0	40	96	0
D3-16TD2	0	180	0	0
AC Output Modules				
D3-04TAS	0	12	0	0
F3-08TAS-1	0	200	0	0
D3-08TA-1	0	160	0	0
D3-08TA-2	0	160	0	0
F3-16TA-2	0	250	0	0
D3-16TA-2	0	400	0	0

Power Supplied				
Device	5V(mA)	9V(mA)	24V(mA)	24 V (mA)
D3-05B-1	900	2000	500	100
D3-08B-1	900	2000	500	100
D3-10B-1	900	2000	500	100
D3-05BDC	900	2000	500	None
D3-10BDC	900	2000	500	None
D3-05B-NR	900	2000	500	100
D3-08B-NR	900	2000	500	100
D3-05BDC-NR	900	2000	500	None
Power Consumed				
Device	5V(mA)	9V(mA)	24V(mA)	External required
Relay Output Modules				
D3-08TR	0	360	0	0
F3-08TRS-1	0	296	0	0
F3-08TRS-2	0	296	0	0
D3-16TR	0	480	0	0
Analog Temperature and Thermocouple Modules				
F3-04ADS	0	183	50	0
F3-08AD-1	0	45	55	0
F3-08THM-n	0	50	34	0
F3-16AD	0	55	65	0
F3-04DA-1	0	144	108	0
F3-04DAS	0	154	145	0
Communications and Networking				
D3-232 DCU	500	0	0	Optional 5V@500mA
D3-422 DCU	500	0	0	Optional 5V@500mA
FA-UNICON	0	0	0	24V or 5V@ 100mA
D3- DCM	0	300	0	0
Specialty Modules				
D3-08SIM	0	10	112	0
D3-HSC	0	70	0	0
D3-TCSU	40	5	0	0
Programming				
D3-HP	50	50	0	0
D3-HPP	50	50	0	0
D2-HP	200	0	0	0
Specialty CPUs				
F3-OMUX-1	409	0	0	0
F3-OMUX-2	262	0	150	0
F3-PMUX	455	0	0	0
F3-RTU	416	0	0	0
Operator Interface				
DV-1000	150	0	0	0
C-more Micro-Graphic	210	0	0	0

Wiring Solutions using the ZIPLink Wiring System

ZIPLinks eliminate the normally tedious process of wiring between devices by utilizing prewired cables and DIN rail mount connector modules. It's as simple as plugging in a cable connector at either end or terminating wires at only one end. Prewired cables keep installation clean and efficient, using half the space at a fraction of the cost of standard terminal blocks. There are several wiring solutions available when using the ZIPLink System ranging from

PLC I/O-to-ZIPLink Connector Modules that are ready for field termination, options for connecting to third party devices, GS, DuraPulse and SureServo Drives, and specialty relay, transorb and communications modules. Pre-printed I/O-specific adhesive label strips for quick marking of ZIPLink modules are provided with ZIPLink cables. See the following solutions to help determine the best ZIPLink system for your application.

Solution 1: DirectLOGIC, CLICK and Productivity3000 I/O Modules to ZIPLink Connector Modules

When looking for quick and easy I/O-to-field termination, a ZIPLink connector module used in conjunction with a prewired ZIPLink cable, consisting of an I/O terminal block at one end and a multi-pin connector at the other end, is the best solution.



Using the PLC I/O Modules to ZIPLink Connector Modules selector tables located in this section,

1. Locate your I/O module/PLC.
2. Select a ZIPLink Module.
3. Select a corresponding ZIPLink Cable.

Solution 2: DirectLOGIC, CLICK and Productivity3000 I/O Modules to 3rd Party Devices

When wanting to connect I/O to another device within close proximity of the I/O modules, no extra terminal blocks are necessary when using the ZIPLink Pigtail Cables. ZIPLink Pigtail Cables are prewired to an I/O terminal block with color-coded pigtail with soldered-tip wires on the other end.



Using the I/O Modules to 3rd Party Devices selector tables located in this section,

1. Locate your PLC I/O module.
2. Select a ZIPLink Pigtail Cable that is compatible with your 3rd party device.

Solution 3: GS Series and DuraPulse Drives Communication Cables

Need to communicate via Modbus RTU to a drive or a network of drives?

ZIPLink cables are available in a wide range of configurations for connecting to PLCs and SureServo, SureStep, Stellar Soft Starter and AC drives. Add a ZIPLink communications module to quickly and easily set up a multi-device network.

Using the Drives Communication selector tables located in this section,

1. Locate your Drive and type of communications.
2. Select a ZIPLink cable and other associated hardware.



Solution 4: Serial Communications Cables

ZIPLink offers communications cables for use with *Direct*LOGIC, CLICK, and Productivity3000 CPUs, that can also be used with other communications devices. Connections include a 6-pin RJ12 or 9-pin, 15-pin and 25-pin D-sub connectors which can be used in conjunction with the RJ12 or D-Sub Feedthrough modules.

Using the **Serial Communications Cables** selector table located in this section,

1. Locate your connector type
2. Select a cable.



Solution 5: Specialty ZIPLink Modules

For additional application solutions, ZIPLink modules are available in a variety of configurations including stand-alone relays, 24VDC and 120VAC transorb modules, D-sub and RJ12 feedthrough modules, communication port adapter and distribution modules, and *SureServo* 50-pin I/O interface connection.

Using the **ZIPLink Specialty Modules** selector table located in this section,

1. Locate the type of application.
2. Select a ZIPLink module.



Solution 6: ZIPLink Connector Modules to 3rd Party Devices

If you need a way to connect your device to terminal blocks without all that wiring time, then our pigtail cables with color-coded soldered-tip wires are a good solution. Used in conjunction with any compatible ZIPLink Connector Modules, a pigtail cable keeps wiring clean and easy and reduces troubleshooting time.

Using the **Universal Connector Modules and Pigtail Cables** table located in this section,

1. Select module type.
2. Select the number of pins.
3. Select cable.



DL305 PLC Input Module ZIPLink Selector				
PLC		ZIPLink		
Input Module	# of Terms	Component	Module Part No.	Cable Part No.
D3-08ND2 ¹	10	See Note 1		
D3-16ND2-1	18	Feedthrough	ZL-RTB20	ZL-D3-CBL18*
D3-16ND2F	18	Feedthrough	ZL-RTB20	ZL-D3-CBL18*
D3-16ND3F	18	Feedthrough	ZL-RTB20	ZL-D3-CBL18*
D3-08NA-1 ¹	10	See Note 1		
D3-08NA-2 ¹	10	See Note 1		
D3-16NA	18	Feedthrough	ZL-RTB20	ZL-D3-CBL18*
D3-08NE3 ¹	10	See Note 1		
D3-16NE3	18	Feedthrough	ZL-RTB20	ZL-D3-CBL18*
		Sensor	ZL-LTB16-24	ZL-D3-CBL18*

DL305 PLC Analog Module ZIPLink Selector				
PLC		ZIPLink		
Analog Module	# of Terms	Component	Module	Cable
F3-04ADS	18	Feedthrough	ZL-RTB20	ZL-D3-CBL18*
F3-08AD-1	18	Feedthrough	ZL-RTB20	ZL-D3-CBL18*
F3-16AD	18	Feedthrough	ZL-RTB20	ZL-D3-CBL18*
F3-04DA-1	18	Feedthrough	ZL-RTB20	ZL-D3-CBL18*
F3-04DAS	18	Feedthrough	ZL-RTB20	ZL-D3-CBL18*
F3-08THM-J ³	T/C Wire Only	See Note 3		
F3-08THM-K ³	T/C Wire Only	See Note 3		



NOTE: ZIPLINK CONNECTOR MODULES SPECIFICATIONS FOLLOW THE COMPATIBILITY MATRIX TABLES. ZIPLINK CABLES SPECIFICATIONS ARE AT THE END OF THIS ZIPLINK SECTION.



DL305 PLC Output Module ZIPLink Selector				
PLC		ZIPLink		
Output Module	# of Terms	Component	Module Part No.	Cable Part No.
D3-04TD1 ¹	10	See Note 1		
D3-08TD1 ¹	10	See Note 1		
D3-08TD2 ¹	10	See Note 1		
D3-16TD1-1	18	Feedthrough	ZL-RTB20	ZL-D3-CBL18*
		Fuse	ZL-RFU20 ⁴	ZL-D3-CBL18*
		Relay (sinking)	ZL-RRL16-24-1	ZL-D3-CBL18*
D3-16TD2	18	Feedthrough	ZL-RTB20	ZL-D3-CBL18*
		Fuse	ZL-RFU20 ⁴	ZL-D3-CBL18*
		Relay (sourcing)	ZL-RRL16-24-2	ZL-D3-CBL18*
D3-04TAS ¹	10	See Note 1		
F3-08TAS-1	18	Feedthrough	ZL-RTB20	ZL-D3-CBL18*
D3-08TA-1	18	Feedthrough	ZL-RTB20	ZL-D3-CBL18*
D3-08TA-2 ¹	10	See Note 1		
F3-16TA-2	18	Feedthrough	ZL-RTB20	ZL-D3-CBL18*
		Fuse	ZL-RFU20 ⁴	ZL-D3-CBL18*
D3-16TA-2	18	Feedthrough	ZL-RTB20	ZL-D3-CBL18*
		Fuse	ZL-RFU20 ⁴	ZL-D3-CBL18*
D3-08TR ¹	10	See Note 1		
D3-16TR ²	18	Feedthrough	ZL-RTB20	ZL-D3-CBL18*
		Fuse	ZL-RFU20 ⁴	ZL-D3-CBL18*
F3-08TRS-1 ²	18	Feedthrough	ZL-RTB20	ZL-D3-CBL18*
F3-08TRS-2 ²	18	Feedthrough	ZL-RTB20	ZL-D3-CBL18*

* Select the cable length by replacing the * with: Blank = 0.5m, -1 = 1.0m, or -2 = 2.0m.

¹ These I/O modules have non-removable terminal blocks which can be terminated using the ZL-CBL24-1P or 2P pigtail cable and the ZL-RTB20 module of the ZIPLink wiring system.

² Caution: The D3-16TR, F3-08TRS-1 and F3-08TRS-2 relay outputs are derated not to exceed 2A per point and 4A per common when used with the ZIPLink wiring system.

³ The F3-08THM-J and F3-08THM-K modules are not supported by the ZIPLink wiring system.

⁴ Note: Fuses (5 x 20 mm) are not included. See Edison Electronic Fuse section for (5 x 20 mm) fuse. S500 and GMA electronic circuit protection for fast-acting maximum protection. S506 and GMC electronic circuit protection for time-delay performance. Ideal for inductive circuits.

To ensure proper operation, do not exceed the voltage and current rating of ZIPLink module. ZL-RFU20 = 2A per circuit; ZL-RFU40 = 400 mA per circuit.

Field I/O

Software

C-more & other HMI

Drives

Soft Starters

Motors & Gearbox

Steppers/ Servos

Motor Controls

Proximity Sensors

Photo Sensors

Limit Switches

Encoders

Current Sensors

Pressure Sensors

Temperature Sensors

Pushbuttons/ Lights

Process

Relays/ Timers

Comm.

Terminal Blocks & Wiring

Power

Circuit Protection

Enclosures

Tools

Pneumatics

Safety

Appendix

Product Index

Part # Index