

DINnectors Accessories

DIN rail

35 mm wide

These quality DIN rails are provided in one-meter lengths and two heights, 7.5 mm and 15 mm. The 7.5 mm-high rails are primarily used to mount terminal blocks, relays, timers and small PLCs such as the DL05, DL06, DL105, DL205, CLICK, and Productivity3000.

The 15 mm-high rails are for mounting larger and heavier components such as contactors and larger PLCs.

15 mm wide

The one-meter-long type DN-R15S1 DIN rail is used exclusively for mounting mini terminal blocks such as the DN-M10-A.



	Part Number	Pcs/Pkg	Price/Pkg	Part#	Pcs/Pkg	Price/Pkg	Part Number	Pcs/Pkg	Price/Pkg
DIN Rail	DN-R35S1	10	<-->	DN-R35HS1	10	<-->	DN-R15S1	10	<-->
	DN-R35S1-2	2	<-->	DN-R35HS1-2	2	<-->	DN-R15S1-2	2	<-->
DINnectors Accessories Specifications									
Description	Steel, slotted, 3'3" (1m) length, 7.5mm high			Steel, slotted, 3'3" (1m) length, 15mm high			Steel, slotted, 3'3" (1m) length, 5.5mm high		
Plating	silver-colored plating								
International Standards	CENELEC EN 50022, DIN 46277/3, RoHS			RoHS			CENELEC EN 50045, DIN 46277/2, RoHS		
Approximate Ampacity	65 Amps			125 Amps			35 Amps		
Suggested Mounting Screw Type	M6			M6			M4		

Dimensions mm [inches]

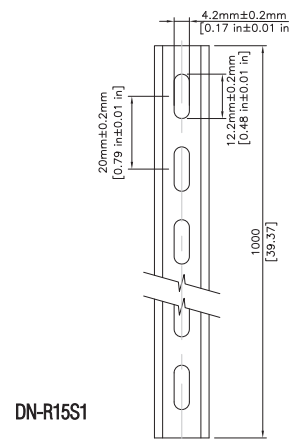
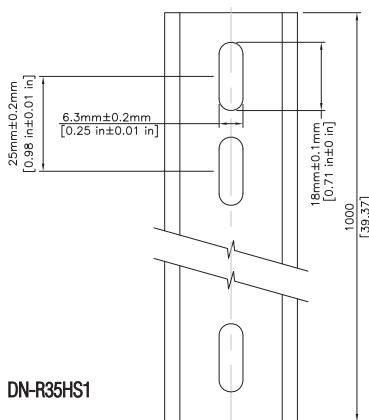
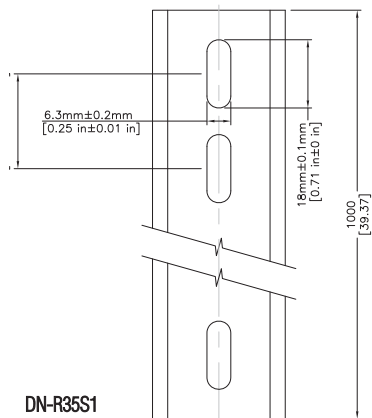
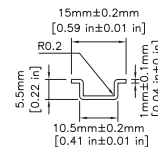
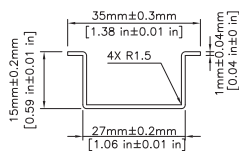
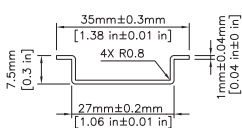

Angled support bracket

DN-ASB1 plated steel support brackets raise and tilt mounting rails for easier wiring.

Part Number	Pcs/Pkg	Price Each
DN-ASB1	50	<-->
*Uses M6x1 metric fixing screw for mounting DIN rail to bracket; additional 5 mm unthreaded mounting hole available.		

DN-ASB1

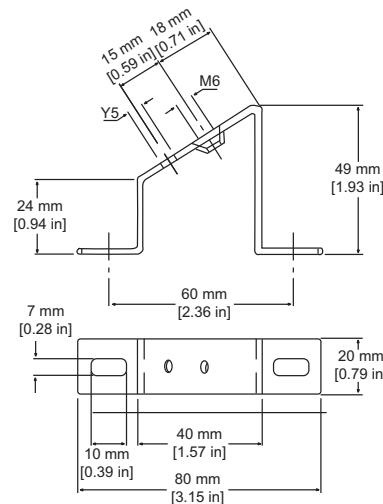

DINnectors Accessories

Jumpers

Multi-pole jumper bars for DINnector terminal blocks

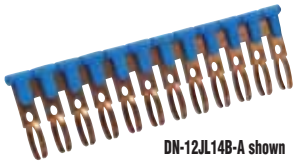

DN-12JL14B-A shown

Dimensions

mm [inches]

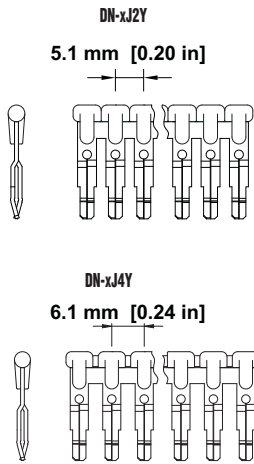

Multi-pole Jumper Bars							
Part Number	Number of Poles	Voltage	Current Rating	Insulation Color	Works with Terminal Block Series	Pcs/Pkg	Price
DN-2J2Y	2	600V	25A	Orange	DN-T12-A, DN-EMX, DN-Q12-A, DN-QD12-A, DN-QEMX, DN-QKBD12-A	100	<-->
DN-2J4Y	2			Yellow	DN-T10-A, DN-D10-A, DN-M10-A, DN-Q10-A	100	<-->
DN-2J6Y	2			Green	DN-Q8-A	100	<-->
DN-2J8	2			---	DN-T8	100	<-->
DN-2J6	2			---	DN-T6	100	<-->
DN-2JL14B-A	2	300V	20A	Blue	DN-TL-A	100	<-->
DN-2JL14-A	2			Red	DN-TL-A	100	<-->
DN-3J2Y	3	600V	25A	Orange	DN-T12-A, DN-EMX, DN-Q12-A, DN-QD12-A, DN-QEMX, DN-QKBD12-A	100	<-->
DN-3J4Y	3			Yellow	DN-T10-A, DN-D10-A, DN-M10-A, DN-Q10-A	100	<-->
DN-3J6Y	3			Green	DN-Q8-A	100	<-->
DN-3J8	3			---	DN-T8	100	<-->
DN-3J6	3			---	DN-T6	100	<-->
DN-3JL14B-A	3	300V	20A	Blue	DN-TL-A	100	<-->
DN-3JL14-A	3			Red	DN-TL-A	100	<-->
DN-4J8	4	600V	50A	---	DN-T8	100	<-->
DN-4J6	4		65A	---	DN-T6	100	<-->
DN-12J6Y	12		30A	Green	DN-Q8-A	10	<-->
DN-12JL14B-A	12	300V	20A	Blue	DN-TL-A	10	<-->
DN-12JL14-A	12			Red	DN-TL-A	10	<-->
DN-24J2Y	24	600V	25A	Yellow	DN-T12-A, DN-EMX, DN-Q12-A, DN-QD12-A, DN-QEMX, DN-QKBD12-A	5	<-->
DN-24J4Y	24			Yellow	DN-T10-A, DN-D10-A, DN-M10-A, DN-Q10-A	5	<-->
DN-55J6	55		50A	---	DN-T6	1	<-->
DN-70J8	70		65A	---	DN-T8	1	<-->

Note: Jumpers can be installed side-by-side (daisy-chained) to allow continuous termination.

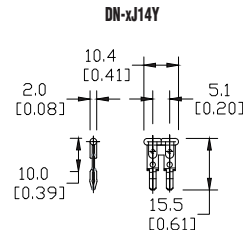
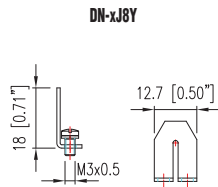
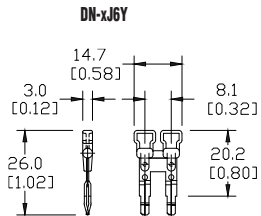

Cutting tool



DN-J2CUT



DN-J4CUT

Cutting Tool for J8 EURO Jumpers			
Part Number	Description	Pcs/Pkg	Price
DN-J2CUT	Cutting tool for DN-2J2Y, DN-3J2Y and DN-24J2Y jumpers. Cuts jumper and maintains protective covering	1	<-->
DN-J4CUT	Cutting tool for DN-2J4Y, DN-3J4Y and DN-24J4Y jumpers. Cuts jumper and maintains protective covering	1	<-->

DINnectors Accessories

Company Information

Systems Overview

Programmable Controllers

Field I/O

Software

C-more & other HMI

Drives

Soft Starters

Motors & Gearbox

Steppers/ Servos

Motor Controls

Proximity Sensors

Photo Sensors

Limit Switches

Encoders

Current Sensors

Pressure Sensors

Temperature Sensors

Pushbuttons/ Lights

Process

Relays/ Timers

Comm.

Terminal Blocks & Wiring

Power

Circuit Protection

Enclosures

Tools

Pneumatics

Safety

Appendix

Product Index

Part #

Index

Terminal Plugs



DN-xxPLUG

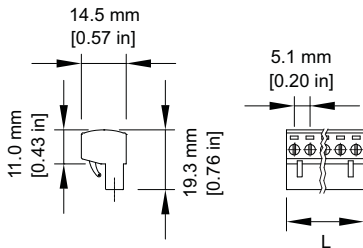

Accessories – Terminal Plugs				
Plugs* Part Number	Number of Poles	Length	Pcs/Pkg	Price/Pkg
DN-2PLUG	2	L = 0.40 in [10.2 mm]	200	<--->
DN-3PLUG	3	L = 0.60 in [15.2 mm]	200	<--->
DN-4PLUG	4	L = 0.80 in [20.3 mm]	100	<--->
DN-5PLUG	5	L = 1.00 in [25.4 mm]	100	<--->
DN-6PLUG	6	L = 1.20 in [30.5 mm]	100	<--->
DN-7PLUG	7	L = 1.40 in [35.6 mm]	50	<--->
DN-8PLUG	8	L = 1.60 in [40.6 mm]	50	<--->
DN-9PLUG	9	L = 1.80 in [45.7 mm]	50	<--->
DN-10PLUG	10	L = 2.00 in [50.8 mm]	50	<--->
DN-11PLUG	11	L = 2.20 in [55.9 mm]	50	<--->
DN-12PLUG	12	L = 2.40 in [61.0 mm]	50	<--->

Terminal Plugs Ratings	
Voltage/Current	300V, 12A
Wire Gauge	14–22 AWG, CU only
Torque	Tightening Torque: 4.5 lb-in [0.51 Nm]
Operating Temperature	Operating Temperature: -13°F to 104°F (-25°C to 40°C) Relative humidity: 50% max at 104°F (40°C); 90% max at 68°F (20°C)
Agency Approvals	UL file #: E179129

* DN-xxPLUGs fit all DN-EMxx & DN-QEMxx plug-in terminal blocks

Disconnect blade



DN-DIS-BLADE

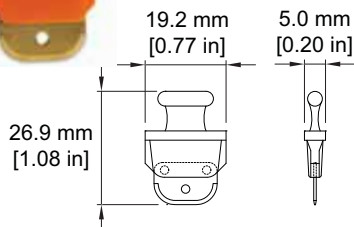

Disconnect Blade			
Part Number	Description	Pcs/Pkg	Price
DN-DIS-BLADE	Use instead of DN-SUPP-x for DN-FE or as replacement for DN-DIS.	50	<--->

Note: Dimensions are in mm [inches]

End Brackets



End Brackets			
Part Number	Description	Pcs/Pkg	Price/Pkg
DN-EB15	Terminal block end stop 7mm width screw clamping. Gray	100	<--->
DN-EB15MN		20	<--->
DN-EB35	Terminal block end stop 9mm width screw clamping. Gray	50	<--->
DN-EB35MN		20	<--->
DN-EB35-A	Terminal block end stop 6mm width screw clamping. Black	50	<--->
DN-EB35-A-10		10	<--->
DN-QEB35	Terminal block end stop 6mm width screwless clamping. Black	50	<--->
DN-QEB35-10		10	<--->

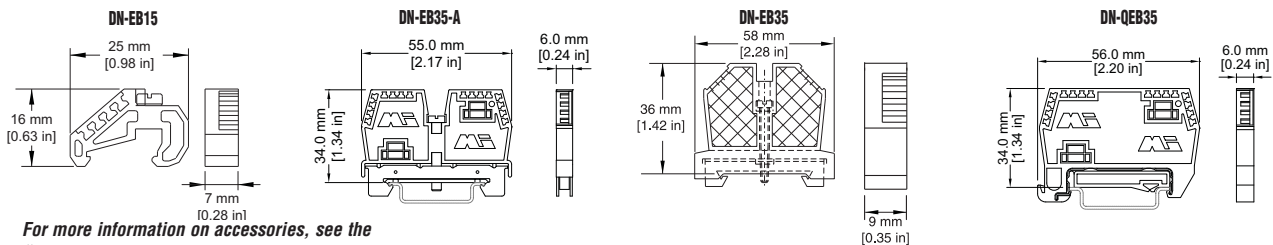

For more information on accessories, see the "DINnectors Accessories" section of this chapter.

DINnectors Accessories

End Covers

Certain end covers can be used with multiple terminal block parts to cover and insulate the open side, or to put more space between adjacent blocks.

DINnector End Covers				
Part Number	Description	Works with terminal block series	Pcs/Pkg	Price
DN-EC1210	Covers open side of DN-T12-A and DN-T10-A series terminal blocks	DN-T10-A, DN-T12-A	100	<-->
DN-EC1210MN			25	<-->
DN-EC86	Covers open side of DN-T8 and DN-T6 series terminal blocks	DN-T8, DN-T6	100	<-->
DN-EC86MN			25	<-->
DN-EC4	Covers open side of DN-T4 series terminal blocks	DN-T4	50	<-->
DN-EC1/0	Covers open side of DN-T1/0 series terminal blocks	DN-T1/0	50	<-->
DN-DEC10	Covers open side of DN-D10 series double-level terminal blocks	DN-D10	100	<-->
DN-EC14	Covers open side of DN-TL14-A series terminal blocks	DN-TL14-A	25	<-->
DN-EC14S	Covers open side of DN-TL14S-A series terminal blocks	DN-TL14S-A	25	<-->
DN-ECM10	Covers open side of DN-M10-A series terminal blocks	DN-M10-A DN-M10B-A	100	<-->
DN-ECM10MN			25	<-->
DN-ECKBD	Covers open side of DN-KBD12 series disconnect blocks	DN-KBD12	100	<-->
DN-EMXM1EC1	Covers open side of DN-EMXM1 and DN-QEMXM1 terminal blocks	DN-EMXM1	25	<-->
DN-EMXM1EC2	Covers closed side of DN-EMXM1 and DN-QEMXM1 terminal blocks	DN-QEMXM1	25	<-->
DN-EMXDVEC1	Covers open side of DN-EMXDV and DN-QEMXDV terminal blocks	DN-EMXDV	25	<-->
DN-EMXDVEC2	Covers closed side of DN-EMXDV and DN-QEMXDV terminal blocks	DN-QEMXDV	25	<-->
DN-FESEP	Covers closed side of DN-FE sockets and DN-DIS disconnects	DN-FE, DN-DIS	50	<-->
DN-FESEP-10			10	<-->
DN-QEC12	Covers open side of DN-Q12-A or DN-QG12-A series screwless terminal blocks	DN-Q12-A	50	<-->
DN-QEC10	Covers open side of DN-Q10-A or DN-QG10-A series screwless terminal blocks	DN-Q10-A	50	<-->
DN-QEC8	Covers open side of DN-Q8-A or DN-QG8-A series screwless terminal blocks	DN-Q8-A	50	<-->
DN-QEC12-1-2	Covers open side of DN-Q12-1-2-A and DN-QKBD12-A series screwless terminal blocks	DN-Q12-1-2-A DN-QKBD12	25	<-->
DN-QEC12-2-2	Covers open side of DN-Q12-2-2-A series screwless terminal blocks	DN-Q12-2-2-A	25	<-->
DN-QDEC12	Covers open side of DN-QD12-A series screwless terminal blocks	DN-QD12-A	25	<-->

Spacers

Spacers are used to put more space between adjacent blocks.

DINnector Spacers				
Part Number	Description	Works with terminal block series	Pcs/Pkg	Price
DN-S1210	Spacer for DN-T12-A and DN-T10-A series terminal blocks	DN-T10-A, DN-T12-A	100	<-->
DN-S1210MN			25	<-->
DN-S86	Spacer for DN-T8 and DN-T6 series terminal blocks	DN-T8, DN-T6	100	<-->
DN-EMXM1SPA1	Spacer for single-level plug-in terminal blocks	DN-EMXM1, DN-QEMXM1	25	<-->
DN-EMXDVSPA1	Spacer for double-level plug-in terminal blocks	DN-EMXDV, DN-QEMXDV	25	<-->
DN-FESPA	Spacer for DN-FE sockets and DN-DIS disconnects	DN-FE, DN-DIS	50	<-->
DN-FESPA-10			10	<-->

DINnectors Accessories

- Company Information
- Systems Overview
- Programmable Controllers
- Field I/O
- Software
- C-more & other HMI
- Drives
- Soft Starters
- Motors & Gearbox
- Steppers/ Servos
- Motor Controls
- Proximity Sensors
- Photo Sensors
- Limit Switches
- Encoders
- Current Sensors
- Pressure Sensors
- Temperature Sensors
- Pushbuttons/ Lights
- Process
- Relays/ Timers
- Comm.
- Terminal Blocks & Wiring
- Power
- Circuit Protection
- Enclosures
- Tools
- Pneumatics
- Safety
- Appendix
- Product Index
- Part # Index

DINnector End Covers and Spacers Dimensions

Part Number	Length	Height	Thickness
DN-EC1210	44 mm [1.73 in]	35 mm [1.38 in]	1.5 mm [0.06 in]
DN-EC1210MN			
DN-S1210	55 mm [2.17 in]	44 mm [1.73 in]	
DN-S1210MN	55 mm [2.17 in]	44 mm [1.73 in]	
DN-EC86	50 mm [1.97 in]	43 mm [1.69 in]	
DN-EC86MN			
DN-S86	55 mm [2.17 in]	49 mm [1.93 in]	
DN-EC4	56 mm [2.21 in]	48 mm [1.89 in]	
DN-EC1/0	62 mm [2.44 in]	60 mm [2.36 in]	
DN-DEC10	72 mm [2.80 in]	55 mm [2.17 in]	
DN-EC14	78 mm [3.08 in]	55 mm [2.17 in]	
DN-EC14S	55 mm [2.17 in]	50 mm [1.97 in]	
DN-ECM10	32 mm [1.26 in]	27 mm [1.06 in]	
DN-ECM10MN			
DN-ECKBD	52 mm [2.05 in]	34.5 mm [1.36 in]	
DN-EMXM1EC1	as shown		
DN-EMXM1EC2			
DN-EMXDVEC1			
DN-EMXDVEC2			
DN-EMXDVSPA1			
DN-EMXM1SPA1			
DN-FESPA			
DN-FESPA-10			
DN-FESEP			
DN-FESEP-10			
DN-QEC12	50 mm [1.97 in]	23 mm [0.9 in]	1.5 mm [0.06 in]
DN-QEC10	57.4 mm [2.26 in]	33.6 mm [1.32 in]	
DN-QEC8	63 mm [2.48 in]	38.5 mm [1.52 in]	
DN-QEC12-1-2	68.5 mm [2.70 in]	28.5 mm [1.12 in]	
DN-QEC12-2-2	87.5 mm [3.44 in]	28.5 mm [1.12 in]	
DN-QDEC12	98 mm [3.86 in]	37 mm [1.46 in]	

DN-EC1210, DN-EC1210MN DN-EC86, DN-EC86MN DN-EC4, DN-EC1/0, DN-ECKBD, DN-S1210, DN-S1210MN, DN-S86

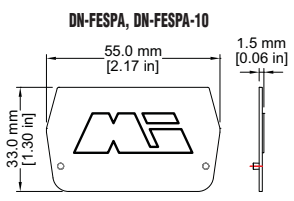
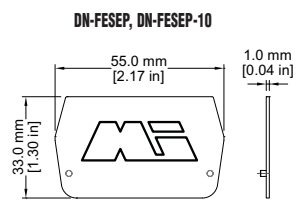
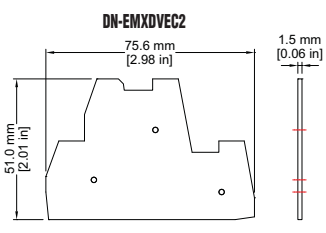
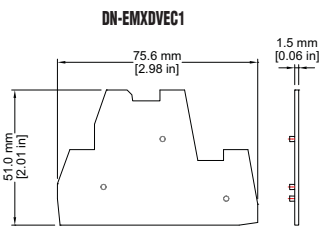
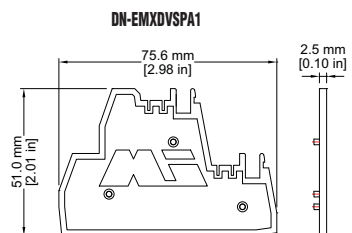
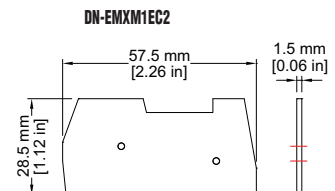
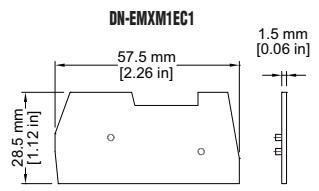
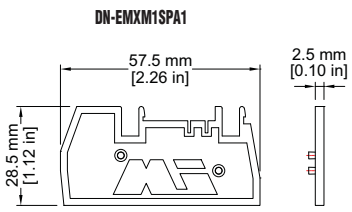
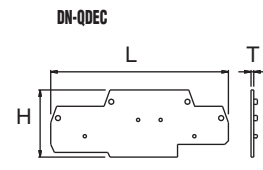
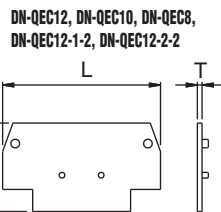
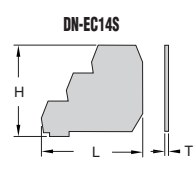
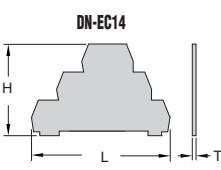
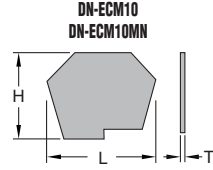
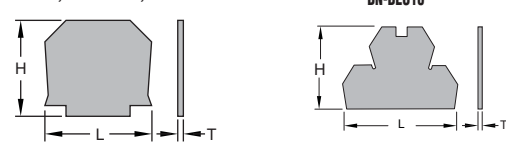

Marking Accessories



DN-LB (blank) shown above

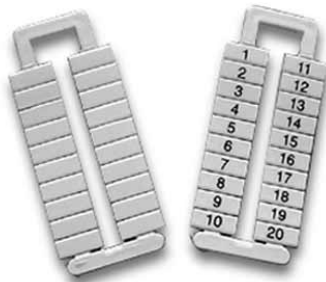

DN-LAB (blank) shown on left; part of DN-LA100 on right



DN-LTA marker shown top; DN-LT60 marker shown middle; DN-LTGND shown bottom

DN-L

Fits terminal block types: All except, Screwless DINnectors, DN-T12-A, DN-M10-A, DN-MG, and DN-TL series

Material: Thermoplastic with heat embossed black print

Note:

- The marking sequence of 50 tags (i.e. 101-150) is printed 10 times in each package of 500 tags.
- The DN-L tags fit all DINnectors 6mm wide and wider.
- The DN-L tags fit all DINnectors 6mm wide and wider but will leave a gap between tags on blocks wider than 6mm.

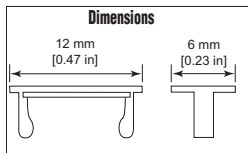

DN-LA

Fits terminal block types: DN-T12-A series

Material: Thermoplastic with heat embossed black print

Note:

- The marking sequence (i.e. 1-100) is printed five times in each package of 500 tags.
- The DN-T12-A series is 5mm wide, so the 6mm wide DN-L tags do not fit these blocks.
- The DN-LA tags fit all DINnectors 5mm wide and wider but will leave a gap between tags on blocks wider than 5mm.

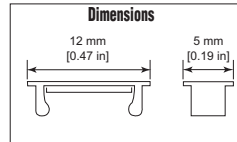

DN-LT

Fits terminal block types: All except Screwless (see DN-QL series)

Material: Thermoplastic with heat embossed black print

Note:

- These marking tags allow the flexibility of creating custom marking sequences on site.
- The DN-M10-A support a maximum of three digits (tags), while other DINnectors support up to four digits (tags)

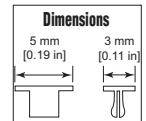

Marking Sequence	Part#	Pcs/Pkg	Price
1-50	DN-L50	500	<--->
51-100	DN-L100	500	<--->
101-150	DN-L150	500	<--->
151-200	DN-L200	500	<--->
201-250	DN-L250	500	<--->
251-300	DN-L300	500	<--->
301-350	DN-L350	500	<--->
351-400	DN-L400	500	<--->
401-450	DN-L450	500	<--->
Blank	DN-LB	500	<--->
L1, L2, L3, L, N, GND, +, -, COM, COM*	DN-LS	500	<--->

Marking Sequence	Part#	Pcs/Pkg	Price
1-100	DN-LA100	500	<--->
101-200	DN-LA200	500	<--->
201-300	DN-LA300	500	<--->
301-400	DN-LA400	500	<--->
Blank Tags	DN-LAB	500	<--->
L1, L2, L3, L, N, GND, +, -, COM, COM*	DN-LAS	500	<--->

Marking Sequence	Part#	Pcs/Pkg	Price
1-5	DN-LT15	100	<--->
6-0	DN-LT60	100	<--->
1	DN-LT1	100	<--->
2	DN-LT2	100	<--->
3	DN-LT3	100	<--->
4	DN-LT4	100	<--->
5	DN-LT5	100	<--->
6	DN-LT6	100	<--->
7	DN-LT7	100	<--->
8	DN-LT8	100	<--->
9	DN-LT9	100	<--->
0	DN-LT0	100	<--->
Unprinted	DN-LTBKLNK	100	<--->
A	DN-LTA	100	<--->
B	DN-LTB	100	<--->
C	DN-LTC	100	<--->
D	DN-LTD	100	<--->
E	DN-LTE	100	<--->
F	DN-LTF	100	<--->
G	DN-LTG	100	<--->
H	DN-LTH	100	<--->
I	DN-LTI	100	<--->
J	DN-LTJ	100	<--->
K	DN-LTK	100	<--->
L	DN-LTL	100	<--->
M	DN-LTM	100	<--->
N	DN-LTN	100	<--->
-	-	-	-
P	DN-LTP	100	<--->
Q	DN-LTQ	100	<--->
R	DN-LTR	100	<--->
S	DN-LTS	100	<--->
T	DN-LTT	100	<--->
U	DN-LTU	100	<--->
V	DN-LTV	100	<--->
W	DN-LTW	100	<--->
X	DN-LTX	100	<--->
Y	DN-LTY	100	<--->
Z	DN-LTZ	100	<--->
⊕	DN-LTGND	100	<--->
+	DN-LTPOS	100	<--->
-	DN-LTNEG	100	<--->
~	DN-LTAC	100	<--->
=	DN-LTDC	100	<--->

DN-QLS

Fits terminal block types: Screwless DN-Q series

Material: Thermoplastic with heat embossed black print. Packaged 100 labels per card, and five cards per box.

Note:

- The marking sequence (i.e. 1-100) is printed five times in each package of 500 tags.

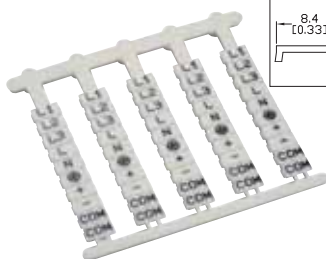
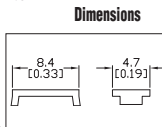

Marking Sequence	Part #	Pcs/Pkg	Price
1-100	DN-QL100	500	<--->
101-200	DN-QL200	500	<--->
201-300	DN-QL300	500	<--->
301-400	DN-QL400	500	<--->
401-500	DN-QL500	500	<--->
Blank Tags ⊕	DN-QLB	500	<--->
L1, L2, L3, L, N, ⊕, +, -, COM, COM*	DN-QLS	500	<--->

DN-LAT

Fits terminal block types: Triple level DN-TL14

Material: Thermoplastic with heat embossed black print

Note:

- The marking sequence (i.e. 1-100) is printed five times in each package of 500 tags.

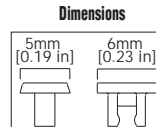

Marking Sequence	Part #	Pcs/Pkg	Price
1-100	DN-LAT100-A	500	<--->
101-200	DN-LAT200-A	500	<--->
201-300	DN-LAT300-A	500	<--->
301-400	DN-LAT400-A	500	<--->
401-500	DN-LAT500-A	500	<--->
501-600	DN-LAT600-A	500	<--->
Blank Tags	DN-LATB-A	500	<--->
L1, L2, L3, L, N, ⊕, +, -, COM, COM*	DN-LATS-A	500	<--->

DINnectors Accessories – Marking

Terminal Marking Accessories



DN-EMLBL1



DN-EMLBL2



DN-EMLBL3

Part #	Description	For Use With	Pcs/Pkg	Price Each
DN-EMLBL1	Blank labels	DN-EMPEG1 pin protectors for DN-xEMxxx plug-in terminal blocks	100	<--->
DN-EMLBL2	Labels printed 1 – 12		100	<--->
DN-EMLBL3	Labels printed 13 – 24		100	<--->

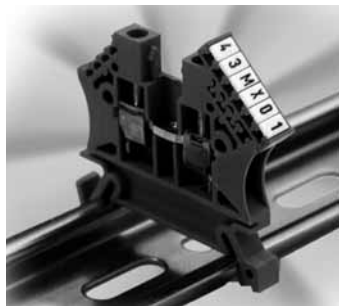

DN-MTA marking tag adapter

DN-MTA dimensions

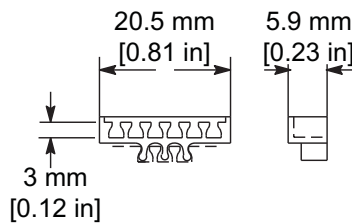

Part#	Description	Pcs/Pkg	Price Each
DN-MTA	Marking tag adapter holds up to six DN-LT tags	50	<--->

Note:
DN-MTA adapter does not fit DN-T12-A terminal blocks.

Marking Pen – for terminal and wire marking tags

- Permanent
- Smudge-proof
- Waterproof
- Weatherproof
- Lightfast (won't fade)
- Dries in seconds (excellent for left-handed users)
- Dry-safe (pen can be left uncapped for days without drying out)
- Low odor ink

Part#	Description	Pcs/Pkg	Price Each
DN-MP	Indelible black ink marking pen	1	<--->



Marking pen

Wire Marking Accessories



DN-WMTAG1 wire tags & DN-WM-x wire tag holders

Part #	Description	For Use With	Pcs/Pkg	Price Each
DN-WMTAG1	Wire tag – blank	all DN-WM-x wire tag holders	525	<--->
DN-WM-1	Wire tag holder, clear, 12 mm length, 0.051–0.118 in diameter; for 22–16 AWG wire	DN-WMTAG1	200	<--->
DN-WM-2	Wire tag holder, clear, 12 mm length, 0.098–0.196 in diameter; for 16–11 AWG wire		200	<--->
DN-WM-3	Wire tag holder, clear, 12 mm length, 0.157–0.393 in diameter; for 13–5 AWG wire		100	<--->
DN-WM-4	Wire tag holder, clear, 12 mm length, 0.314–0.629 in diameter; for 5 AWG wire		100	<--->