

# E22 Illuminated Pushbuttons

## Illuminated pushbuttons



Note: Bulb removal tool available. See replacement bulbs on the accessories page.

Illuminated Pushbuttons			
24V AC/DC Full Voltage			Price
Red	<b>E22TB2X4B</b>	Momentary illuminated pushbutton, black bezel, extended red button with one N.C. contact, 24V full voltage light unit	<--->
Green	<b>E22TB3X4A</b>	Momentary illuminated pushbutton, black bezel, extended green button with one N.O. contact 24V full voltage light unit	<--->
Amber	<b>E22TB9X4A</b>	Momentary illuminated pushbutton, black bezel, extended amber button with one N.O. contact, 24V full voltage light unit	<--->
120V AC Resistor			
Red	<b>E22TB2X10B</b>	Momentary illuminated pushbutton, black bezel, extended red button with one N.C. contact, 120V resistor light unit	<--->
Green	<b>E22TB3X10A</b>	Momentary illuminated pushbutton, black bezel, extended green button with one N.O. contact, 120V resistor light unit	<--->
Amber	<b>E22TB9X10A</b>	Momentary illuminated pushbutton, black bezel, extended amber button with one N.O. contact, 120V resistor light unit	<--->

See specifications and mounting data at the beginning of this section.

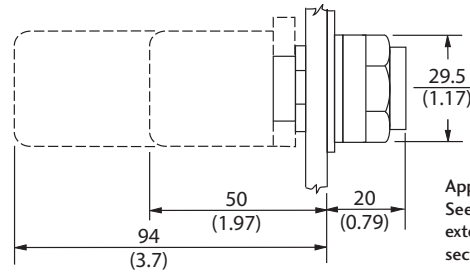

Approximate dimensions in mm (in). See dimensions for "back-of-panel extensions" at the beginning of this section.

## Illuminated double-headed pushbutton



Illuminated Pushbutton			
Double-headed Pushbutton			Price
Green-Red	<b>E22DB1B20X11C</b>	Illuminated double headed pushbutton with clear lens, 0 and 1 legend markings, 120V transformer light unit, one N.O. and one N.C. contact	<--->

See specifications and mounting data at the beginning of this section.

Note: This IP65 or UL (NEMA) Type 3, 3R, 4, 4X, 12, 13 pushbutton includes a protective clear silicone boot.

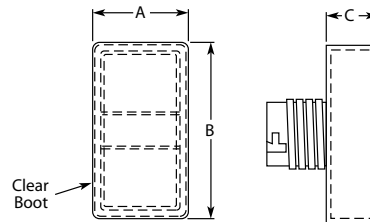

Overall Dimensions (in/mm)		
Dimension	With Boot	Without Boot
A	1.19 (30.2)	1.11 (28.2)
B	2.28 (57.9)	2.20 (55.9)
C	0.68 (17.3)	0.48 (12.2)

## Mushroom pushbutton station



Mushroom Pushbutton Station			
Emergency Stop Station			Price
Red/Yellow	<b>E22ASB106</b>	Latch in, twist-to-release 40mm red mushroom pushbutton, black bezel, with one N.C. contact.	<--->

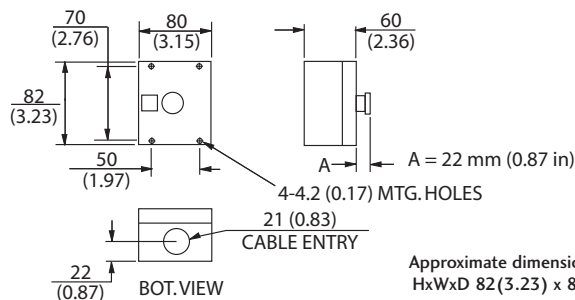

Approximate dimensions in mm (in). HxWxD 82(3.23) x 80(3.15) x 60(2.36)

Ingress Protection (IP) Rating	
(IP65, IP66 ratings to IEC 529) UL Listed (NEMA) Types 1, 2, 3, 3R, 4, 4X, 12, and 13 when mounted in an enclosure rated for those same applications. See pages 30-9 and 30-10 for descriptions.	
Electrical Specifications	
<b>Electrical Rating</b>	UL508; UL File E131568. CSA certified class 3211 03, LR 68551. NEMA ICS5-2000: A600, Q600 (refer to page 22-26). IEC 60947-5-1: AC15, DC13.
Maximum Frequency of Operation	
<b>22 mm Pushbuttons</b>	6,000 operations/hour IEC 60947-5-1: AC15, DC13.
<b>Key and Lever Selector Switches</b>	3,000 operations/hour
<b>Twist-to-Release Devices</b>	1,200 operations/hour
<b>Push-Pull Operators</b>	3,000 operations/hour
Mechanical Life	
<b>Pushbutton</b>	5 million operations
<b>Selector Switches</b>	500,000 operations
<b>Push-Pull and Twist-to-Release</b>	300,000 operations
<b>Contact Block</b>	3 million operations
Environmental Specifications	
<b>Operating Temperature</b>	Maximum 60° C at 95% RH, -20° to 60° C (-14° to 140° F), altitude 2000 meters
<b>Storage Temperature</b>	Maximum 60° C at 95% RH, -40° to 80° C (-40° to 176° F)
Vibration	
<b>Vibration</b>	5G/0.7mm peak-to-peak 10 sweeps, 10-500 Hz
<b>Shock</b>	18G, 18ms
<b>Bump</b>	25G, 6ms for 1,000 cycles
Construction	
<b>Components</b>	<b>Materials</b>
<b>Housing, Bezel, Mounting Rings</b>	Glass-filled nylon
<b>Internal Seal</b>	Nitrate rubber
<b>Panel Gasket</b>	Nitrate rubber
<b>Illuminated Lenses</b>	Polycarbonate
<b>Buttons</b>	Polyester or polycarbonate
<b>Springs</b>	Stainless steel
<b>Contacts</b>	Silver
<b>Terminal Screws/Terminals</b>	Brass
Panel Thickness - Inches (mm)	
<b>Nominal</b>	0.27 (6.8) <sup>1</sup>
<b>Aluminum Legend Plates</b>	0.05 (1.3)
<b>Large Yellow Round Legend Plates</b>	0.04 (1.0)
<b>Minimum</b>	0.04 (1.0)
<sup>1</sup> Installation of certain accessories will increase the total (overall) panel thickness by the amount shown. The total panel thickness with all accessories installed cannot exceed the maximum allowable nominal dimensions of 0.27 in. (6.8 mm).	
Wire Specifications	
<b>Minimum/Maximum</b>	18AWG (0.75mm <sup>2</sup> ) / 12AWG (2.5mm <sup>2</sup> )
<b>Tightening Torque</b>	7lb./in.

## Electrical life

- AC15 durability: 120V, 6A 1 X 10<sup>6</sup> operations
- DC13 durability: 24V, 8A 0.15 X 10<sup>6</sup> operations  
660V, .1A 0.5 X 10<sup>6</sup>

## Logic-level operation

**5 VDC, 1 mA (minimum recommended)**

Contacts feature a pointed surface called "Reliability Nib." The projection penetrates through any oxidation providing unmatched low-level operation without using exotic metals or sealed contacts.

## Standards and approvals

- UL listed – UL 508 electrical/environmental; UL 486E terminal secureness, File E131568
- CSA Certified – CSA 22.2 #14
- NEMA ICS-1, ICS-2
- IEC 144, 337, 529, 947
- IP65 when mounted in enclosure
- Lloyds No. 4 and 5
- M.T.T.A.
- CE

## IEC utilization categories & ratings

### AC15

(Control of AC electromagnetic loads)

- 24 volts AC at 10 amps
- 130 volts AC at 6.5 amps

### DC13

(Control of DC electromagnetic loads)

- 24 volts DC at 1.5 amps
- 110 volts DC at .5 amps

# E22 Mounting / NEMA Aux Contact Ratings

## Mounting

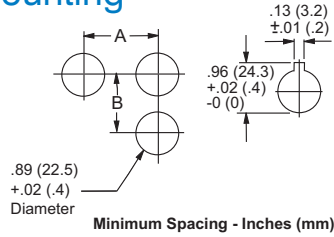

Minimum Spacing — Inches (mm)		
Size/Type of Operator	Dimensions	
	A	B
All types up to 1.18 (30) dia. including knob and key operated selector switches — except those listed below	1.18 (30)	1.97 (50)
Three-way adapter		
1.97 (50) dia. operators	2.16 (55)	2.16 (55)
Large yellow round legend plate - 2.76 (70) Dia.	2.95 (75)	1.97 (50)

## Back-of-panel extensions

Note: This view is to show dimensions only. Contact blocks are not stackable.

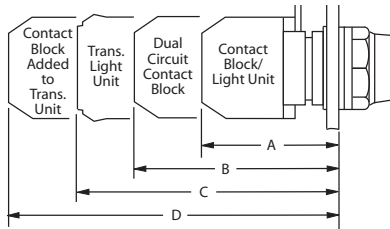

Approximate Dimensions — Inches (mm)			
A	B	C	D
Single circuit block — full voltage and resistor units	Dual circuit contact block	Transformer light unit	Transformer light unit and single circuit contact block
<b>Pushbuttons (All Types and Push-Pull)</b>			
2.0 (51)	2.6 (66)	2.91 (74)	3.7 (94)
<b>Key and Knob Selector Switches</b>			
2.2 (57)	2.83 (72)	3.15 (80)	3.9 (99)

## Control Circuit Contact Electrical Ratings

Typical Wiring - See page 22-6  
Note drawing

NEMA Mechanical Switching Ratings and Test Values for DC Control Circuit Contacts					
Contact Rating Designation	Thermal Continuous Test Current (A)	Maximum Make or Break DC Current (A)			Volt amperes
		125 Volts	250 Volts	301 to 600 Volts	
P300	5.0	1.1	0.55	---	138
P600	5.0	1.1	0.55	0.20	138
Q300	2.5	0.55	0.27	---	69
Q600	2.5	0.55	0.27	0.10	69
R300	1.0	0.22	0.11	---	28

*This chart is provided as a guideline only, and the ratings and values are not guaranteed to be accurate. It is the users' responsibility to properly size their control circuit devices. The chart values are from NEMA Standard ICS 5-2000, Table 1-4-2.*

NEMA Mechanical Switching Ratings and Test Values for AC Control Circuit Contacts											
Contact Rating Designation	Thermal Continuous Test Current (A)	Maximum AC Current, 50/60Hz (A)								Volt amperes	
		120 Volts		240 Volts		480 Volts		600 Volts			
		Make	Break	Make	Break	Make	Break	Make	Break	Make	Break
A300	10	60	6.00	30	3.00	---	---	---	---	7200	720
A600	10	60	6.00	30	3.00	15	1.50	12	1.20	7200	720
B300	5	30	3.00	15	1.50	---	---	---	---	3600	360
B600	5	30	3.00	15	1.50	7.5	0.75	6	0.60	3600	360
C600	2.5	15	1.5	7.5	0.75	3.75	0.375	3.00	0.30	1800	180

*This chart is provided as a guideline only, and the ratings and values are not guaranteed to be accurate. It is the users' responsibility to properly size their control circuit devices. The chart values are from NEMA Standard ICS 5-2000, Table 1-4-1.*