

Illuminated pushbuttons



Note: Bulb removal tool available. See replacement bulbs on the accessories page.

Illuminated double-headed pushbutton



Mushroom pushbutton station



Illuminated Pushbuttons			
24V AC/DC Full Voltage			Price
Red	E22TB2X4B	Momentary illuminated pushbutton, black bezel, extended red button with one N.C. contact, 24V full voltage light unit	<--->
Green	E22TB3X4A	Momentary illuminated pushbutton, black bezel, extended green button with one N.O. contact 24V full voltage light unit	<--->
Amber	E22TB9X4A	Momentary illuminated pushbutton, black bezel, extended amber button with one N.O. contact, 24V full voltage light unit	<--->
120V AC Resistor *			
Red	E22TB2X10B	Momentary illuminated pushbutton, black bezel, extended red button with one N.C. contact, 120V resistor light unit	<--->
Green	E22TB3X10A	Momentary illuminated pushbutton, black bezel, extended green button with one N.O. contact, 120V resistor light unit	<--->
Amber	E22TB9X10A	Momentary illuminated pushbutton, black bezel, extended amber button with one N.O. contact, 120V resistor light unit	<--->

* Use 60V replacement lamp (W1226) for 120 VAC resistor models

Dimensions: mm [inches]

See dimensions for "back-of-panel extensions" at the beginning of this section.

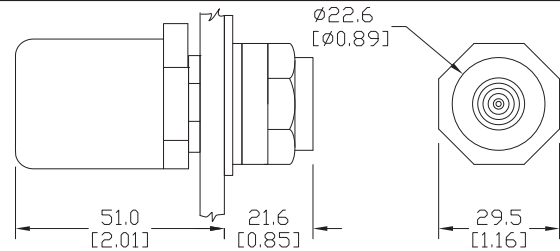

Illuminated Pushbutton			
Double-headed Pushbutton **			Price
Green-Red	E22DB1B20X11C	Momentary illuminated double-headed pushbutton with clear lens, O and I legend markings, 120V transformer light unit, one N.O. and one N.C. contact	<--->

See specifications and mounting data at the beginning of this section.

Note: This IP65 or UL (NEMA) Type 3, 3R, 4, 4X, 12, 13 pushbutton includes a protective clear silicone boot.

** Use 6V replacement lamp (ECX1900-5)

Dimensions: mm [inches]

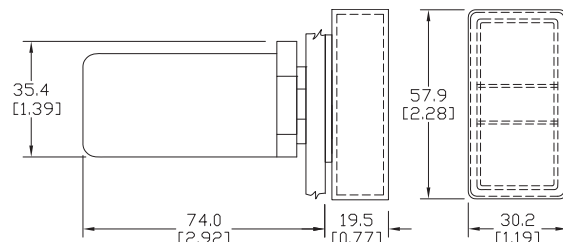

Mushroom Pushbutton Station			
Emergency Stop Station			Price
Red/Yellow	E22ASB106	Latch in, twist-to-release 40mm red mushroom pushbutton, black bezel, with one N.C. contact.	<--->

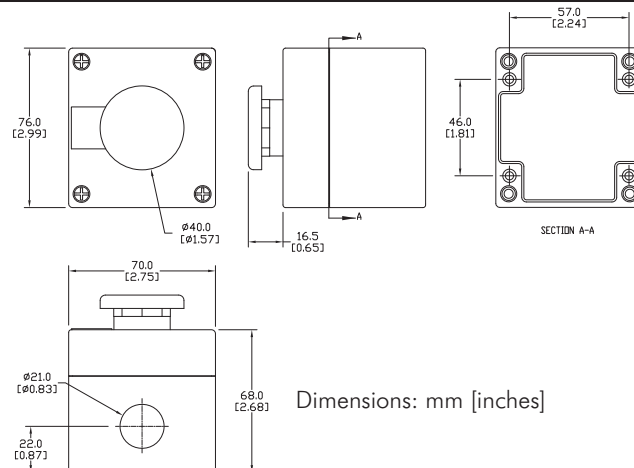

Dimensions: mm [inches]

The European Machinery Safety Directive EN 418 requires all emergency OFF devices to be self-latching types and to have positive (direct) opening operation. Devices have to be manually reset. EN 418 states that actuators shall be mushroom head type and colored **RED**. The background immediately around the device actuator should be colored **YELLOW** (see the E22 accessories in this section to order legend plate part number E22VA8 or guard part number E22MGTA).



E22VA8



E22MGTA

The E22LTA2QB Emergency Stop pushbutton, in conjunction with direct-opening action contact blocks and either a yellow nameplate or yellow guard, is fully compliant with this safety directive, and is third-party certified by DEMKO.



A



B

CE EN 418 Compliant Non-illuminated Emergency Stop Mushroom Pushbuttons			
(A) Red	E22LTA2QB	Trigger action twist-to-release Maintained 40mm red mushroom pushbutton, Emergency Stop, black bezel, with one N.C. contact	<--->
(B) Red	E22LPB2B	Push-Pull Maintained 40mm red mushroom pushbutton, Emergency Stop, black bezel, with one N.C. contact	<--->
(C) Red	E22JLB2N8B	Push-Pull Maintained 50 mm red aluminum mushroom pushbutton, Emergency Stop engraved, black bezel, with one N.C. contact	<--->
(D) Red	E22JPLB2B	Push-Pull Maintained 50 mm red mushroom pushbutton, not engraved, black bezel, with one N.C. contact	<--->

Note: E22MGTA fits E22LTA2QB.

It is not recommended for use with devices that are not EN-418 compliant.

Non-illuminated Mushroom Pushbuttons (NOT CE EN 418 Compliant)			
(E) Red	E22JPB2B	Momentary 50 mm red mushroom pushbutton, black bezel, with one N.C. contact	<--->
(F) Red	E22LB2B	Momentary 40 mm red mushroom pushbutton, black bezel, with one N.C. contact	<--->
(G) Red	E22LLB2B	Twist release Maintained 40mm red mushroom pushbutton, black bezel, with one N.C. contact	<--->

See specifications and mounting data at the beginning of this E22 series section.

Dimensions A, B

Dimensions: mm [inches]

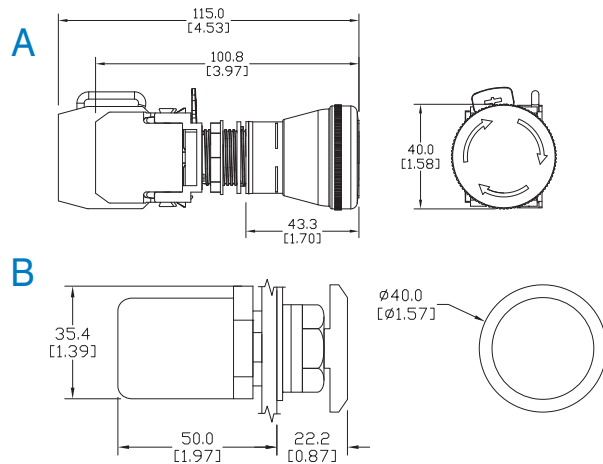

Dimensions C, D, E

Dimensions: mm [inches]



C



D, E

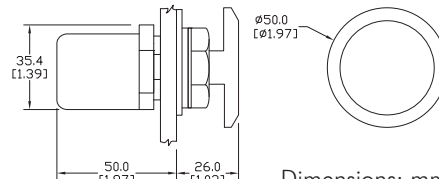

Dimensions F, G

Dimensions: mm [inches]



F



G

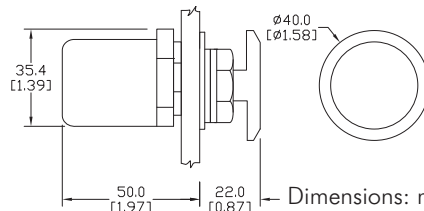

E22 Series Technical Specifications

Ingress Protection (IP) Rating	
(IP65, IP66 ratings to IEC 529) UL Listed (NEMA) Types 1, 2, 3, 3R, 4, 4X, 12, and 13 when mounted in an enclosure rated for those same applications. See pages 30-9 and 30-10 for descriptions.	
Electrical Specifications	
Electrical Rating	UL508; UL File E131568. CSA certified class 3211 03, LR 68551. NEMA ICS5-2000: A600, Q600 (refer to page <None>). IEC 60947-5-1: AC15, DC13.
Maximum Frequency of Operation	
22 mm Pushbuttons	6,000 operations/hour IEC 60947-5-1: AC15, DC13.
Key and Lever Selector Switches	3,000 operations/hour
Twist-to-Release Devices	1,200 operations/hour
Push-Pull Operators	3,000 operations/hour
Mechanical Life	
Pushbutton	5 million operations
Selector Switches	500,000 operations
Push-Pull and Twist-to-Release	300,000 operations
Contact Block	3 million operations
Environmental Specifications	
Operating Temperature	Maximum 60° C at 95% RH, -20° to 60° C (-14° to 140° F), altitude 2000 meters
Storage Temperature	Maximum 60° C at 95% RH, -40° to 80° C (-40° to 176° F)
Vibration	
Vibration	5G/0.7mm peak-to-peak 10 sweeps, 10-500 Hz
Shock	18G, 18ms
Bump	25G, 6ms for 1,000 cycles
Construction	
Components	Materials
Housing, Bezel, Mounting Rings	Glass-filled nylon
Internal Seal	Nitrate rubber
Panel Gasket	Nitrate rubber
Illuminated Lenses	Polycarbonate
Buttons	Polyester or polycarbonate
Springs	Stainless steel
Contacts	Silver
Terminal Screws/Terminals	Brass
Panel Thickness - mm (inches)	
Nominal	6.8 (0.2) ¹
Aluminum Legend Plates	1.3 (0.05)
Large Yellow Round Legend Plates	1.0 (0.04)
Minimum	1.0 (0.04)
¹ Installation of certain accessories will increase the total (overall) panel thickness by the amount shown. The total panel thickness with all accessories installed cannot exceed the maximum allowable nominal dimensions of 6.8 mm (0.27 in.).	
Wire Specifications	
Minimum/Maximum	18AWG (0.75mm ²) / 12AWG (2.5mm ²)
Tightening Torque	7lb./in.

Electrical life

- AC15 durability:
120V, 6A 1 X 10⁶ operations
- DC13 durability:
24V, 8A 0.15 X 10⁶ operations
660V, .1A 0.5 X 10⁶

Logic-level operation

5 VDC, 1 mA (minimum recommended)

Contacts feature a pointed surface called "Reliability Nib." The projection penetrates through any oxidation providing unmatched low-level operation without using exotic metals or sealed contacts.

Standards and approvals

- UL listed – UL 508 electrical/environmental; UL 486E terminal secureness, File E131568
- CSA Certified – CSA 22.2 #14
- NEMA ICS-1, ICS-2
- IEC 144, 337, 529, 947
- IP65 when mounted in enclosure
- Lloyds No. 4 and 5
- M.T.T.A.
- CE

IEC utilization categories & ratings

AC15

(Control of AC electromagnetic loads)

- 24 volts AC at 10 amps
- 130 volts AC at 6.5 amps

DC13

(Control of DC electromagnetic loads)

- 24 volts DC at 1.5 amps
- 110 volts DC at .5 amps

Mounting

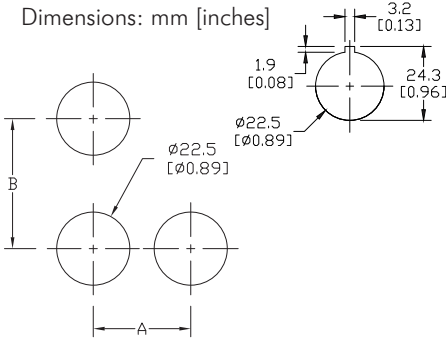

Back-of-panel extensions

Note: This view is to show dimensions only. Contact blocks are not stackable.

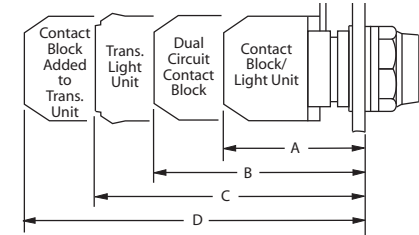

Minimum Spacing — mm [inches]		
Size/Type of Operator	Dimensions	
	A	B
All types up to 30 (1.18) dia. including knob and key operated selector switches — except those listed below	30 (1.18)	50 (1.97)
Three-way adapter		
50 (1.97) dia. operators	55 (2.16)	55 (2.16)
Large yellow round legend plate - 70 (2.76) diameter	75 (2.95)	50 (1.97)

Approximate Dimensions — mm [inches]			
A	B	C	D
Single circuit block — full voltage and resistor units	Dual circuit contact block	Transformer light unit	Transformer light unit and single circuit contact block
Pushbuttons (All Types and Push-Pull)			
51 [2.0]	66 (2.6)	74 (2.91)	94 (3.7)
Key and Knob Selector Switches			
57 [2.2]	72 (2.83)	80 (3.15)	99 (3.9)

Control Circuit Contact Electrical Ratings and Wiring

Typical Wiring

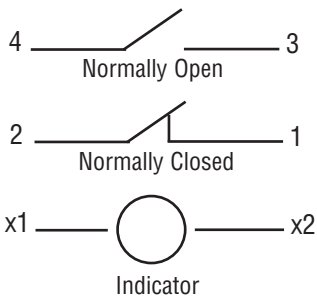

NEMA Mechanical Switching Ratings and Test Values for DC Control Circuit Contacts					
Contact Rating Designation	Thermal Continuous Test Current (A)	Maximum Make or Break DC Current (A)			Volt amperes
		125 Volts	250 Volts	301 to 600 Volts	
P300	5.0	1.1	0.55	---	138
P600	5.0	1.1	0.55	0.20	138
Q300	2.5	0.55	0.27	---	69
Q600	2.5	0.55	0.27	0.10	69
R300	1.0	0.22	0.11	---	28

This chart is provided as a guideline only, and the ratings and values are not guaranteed to be accurate. It is the users' responsibility to properly size their control circuit devices. The chart values are from NEMA Standard ICS 5-2000, Table 1-4-2.

NEMA Mechanical Switching Ratings and Test Values for AC Control Circuit Contacts											
Contact Rating Designation	Thermal Continuous Test Current (A)	Maximum AC Current, 50/60Hz (A)								Volt amperes	
		120 Volts		240 Volts		480 Volts		600 Volts			
		Make	Break	Make	Break	Make	Break	Make	Break	Make	Break
A300	10	60	6.00	30	3.00	---	---	---	---	7200	720
A600	10	60	6.00	30	3.00	15	1.50	12	1.20	7200	720
B300	5	30	3.00	15	1.50	---	---	---	---	3600	360
B600	5	30	3.00	15	1.50	7.5	0.75	6	0.60	3600	360
C600	2.5	15	1.5	7.5	0.75	3.75	0.375	3.00	0.30	1800	180

This chart is provided as a guideline only, and the ratings and values are not guaranteed to be accurate. It is the users' responsibility to properly size their control circuit devices. The chart values are from NEMA Standard ICS 5-2000, Table 1-4-1.

Two-position key switches



Three-position key switches



Key Switches			Price
Two-position Key Switch			
(A) Key	E22KB53A	Selector switch, black bezel, 2-position key, "OFF ON" with one N.O. contact block	<--->
(A) Key	E22KB62A	Selector switch, black bezel, 2-position key, spring from right "OFF ON" with one N.O. contact block	<--->
Three-position Key Switch			
(B) Key	E22KBG7RR	Selector switch, black bezel, 3-position key, "ON ON ON" with two contact blocks, each having one N.O. and one N.C. contact. (Contact part number E22B11)	<--->
(B) Key	E22KBG7D	Selector switch, black bezel, 3-position key, "HAND OFF AUTO" with two N.O. contact blocks	<--->

See specifications and mounting data at the beginning of this E22 series section.

Notes:

All E22 series key switches are keyed alike. The key is not compatible with the metal 22 mm key switches.

All E22 series key switches will hold only one single row of (2) contacts (non-stackable).

Key can be removed in all positions.

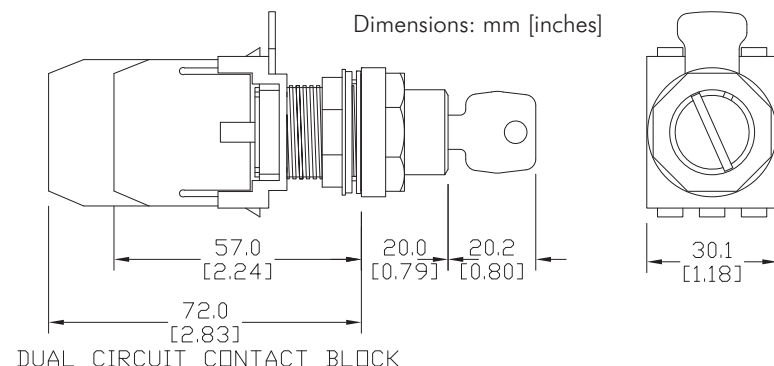

Spare keys available: part no. E22KS2

See dimensions for "back-of-panel extensions" at the beginning of this E22 series section.

Accessories — replacement contact blocks

Replacement Contact Blocks		
Contact Blocks	One block contains:	Price
E22B1*	One N.C. contact (Direct Opening Action)	<--->
E22B2	One N.O. contact	<--->
E22B11*	One N.O., One N.C. contact (N.C. Direct Opening Action)	<--->
E22B20	Two N.O. contacts	<--->
E22CB1M*	Self-monitoring contact block (N.C. Direct Opening Action)	<--->

Note: See contact electrical ratings on E22 series mounting and contact ratings page in this E22 series section.

*All N.C. contact blocks are EN 418 compliant when used with compliant operators.

E22B1

E22B2

E22CB1M

E22B11

E22B20

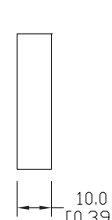
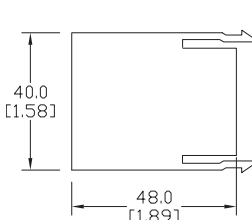
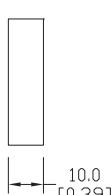
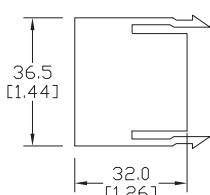

Dimensions: mm [inches]

E22 Accessories

Octagonal wrench



Hole plug

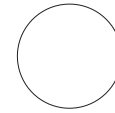
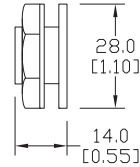

Dimensions: mm [inches]

Bulb removal tool



Guard for E22 E-stop



Accessories		
Part number	Description	Price
HT8WRENCH	Octagonal wrench for tightening back-of-panel mounting nut on all Cutler-Hammer operators.	<--->
E22BHP	Hole plug for unused 22 mm panel holes.	<--->
E22KS2	Spare key for all Cutler-Hammer 22 mm selector switches (not shown)	<--->
HT8LAMPTOOL	Lamp extraction tool for removing lamps from switches, indicators and stacklights	<--->
E22MGTA	22mm yellow guard for E22LTA2QB and E22LPB2B for emergency stop applications.	<--->

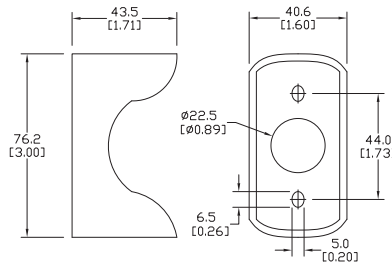

Dimensions: mm [inches]

Replacement incandescent bulbs



Replacement Incandescent Bulbs				
Part Number	Rating	Description	Quantity	Price
ECX1900-5	6V, 1.2 watts	6V replacement bulb for 22 mm switches and indicators. Miniature bayonet base T31/4.	pkg. of 5 bulbs	<--->
ECX1902-5	24V@ 80mA	24V replacement bulb for 22 mm switches and indicators. Miniature bayonet base T31/4.	pkg. of 5 bulbs	<--->
ECX1904-5	130V@20mA	120V replacement bulb for 22 mm switches and indicators. Miniature bayonet base T31/4.	pkg. of 5 bulbs	<--->
W1121	120V@20mA	Replacement bulb for Cutler-Hammer E22 full voltage indicators and switches. Does not replace the LED monoblock indicators.	pkg. of 4 bulbs	<--->
W1226	60V@20mA	Replacement bulb for Cutler-Hammer E22 resistor indicators, switches and pushbuttons. Does not replace the LED monoblock indicators.	pkg. of 4 bulbs	<--->
W1819	24V@20mA	Replacement bulb for Cutler-Hammer E22 indicators and pushbuttons. Does not rbulbeplace the LED monoblock indicators.	pkg. of 4 bulbs	<--->

Replacement LED lamps



Replacement LED Lamps					
Part Number	Color	Rating	Description	Quantity	Price
ECX1911-2	Red	24V@26mA	LED replacement lamp for miniature bayonet bases	pkg. of 2 LED bulbs	<--->
ECX1912-2	Green				<--->
ECX1913-2	Yellow				<--->
ECX1914-2	Blue				<--->
ECX1915-2	White				<--->
ECX1921-2	Red	120V@5mA	Works with 22 mm switches and indicators, but illumination will not be as even when used with the ECX 22 mm indicators		<--->
ECX1922-2	Green				<--->
ECX1923-2	Yellow				<--->
ECX1924-2	Blue				<--->
ECX1925-2	White				<--->

Legend plates

Aluminum legend plates feature a plastisol backing to help prevent rotation of the operator.

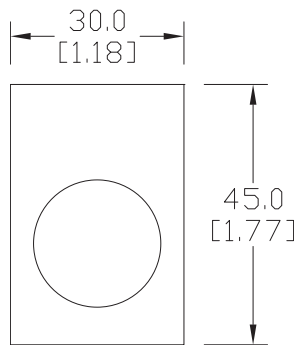

Dimensions: mm [inches]

E22VA8



Legend Plates			
Color	Part Number	Legend	Price
Black	E22NS11	"CLOSE"	<--->
Black	E22NS12	"DOWN"	<--->
Red	E22NS13	"EMERG. STOP"	<--->
Black	E22NS15	"FORWARD"	<--->
Black	E22NS19	"JOG"	<--->
Black	E22NS25	"ON"	<--->
Black	E22NS26	"OPEN"	<--->
Black	E22NS30	"REVERSE"	<--->
Black	E22NS31	"RUN"	<--->
Black	E22NS33	"START"	<--->
Red	E22NS34	"STOP"	<--->
Black	E22NS35	"UP"	<--->
Black	E22NS36	Blank plate	<--->
Red	E22NS37	Blank plate	<--->
Black	E22NS38	"FOR-REV"	<--->
Black	E22NS39	"HAND-AUTO"	<--->
Black	E22NS41	"JOG-RUN"	<--->
Black	E22NS42	"OFF-ON"	<--->
Black	E22NS43	"OPEN-CLOSE"	<--->
Black	E22NS48	"UP-DOWN"	<--->
Black	E22NS50	"FOR-OFF-REV"	<--->
Black	E22NS51	"HAND-OFF-AUTO"	<--->
Black	E22NS80	"POWER ON"	<--->
Black	E22NS81	"MOTOR RUN"	<--->
Black	E22NS82	"MOTOR STOP"	<--->
Black	E22NL36	Jumbo alum. blank plate (1.57 in wide x 1.85 in tall)	<--->
Red	E22NL37	Jumbo alum. blank plate (1.57 in wide x 1.85 in tall)	<--->
Red /black	E22NSP77	Plastic blank plate; red on one side, black on other side; either side can have letters engraved down into white plastic	<--->
Yellow	E22VA8	"EMERGENCY STOP" oversize yellow legend plate, 2.76" (70mm), printed	<--->

NOTE: Legend plates also work with the GCX/ECX series 22 mm metal switches. The removal of the locator tab on the legend plate is required. This is easily accomplished with a round file or small grinder.

E22 Series Cross-reference Tables

Pushbutton, Indicator Light, and Selector Switch Cross Reference				
Cutler-Hammer	Allen-Bradley	Telemecanique XB2B (chrome bezel) XA2B (black bezel)	GE C-2000	Siemens
Non-Illuminated Pushbuttons				
E22PB1A	800EPF2 800E3LX10	ZA2BA2 ZA2BZ101	P9XPNNNG10N0	3SB1000-0AB01 3SB02-CBH 3SB1400-0B
E22PB3A	800EPF3 800E3LX10	ZA2BA3 ZA2BZ101	P9XPNVG10N0	3SB1000-0AE01 3SB02-CBH 3SB1400-0B
E22EB2B	800EPE4 800E3LX01	ZA2BL4 ZA2BZ102	P9XPNRS20N0	3SB1000-0LC01 3SB02-CBH 3SB1400-0B
E22ASB204	ENCLSR: 800E-2P 800EP-F3 800E-2LX10 800EP-E4 800E-2LX01 800E-34BE208 800E-34R212	XALB211 Both flush - stop is not extended	P9CPNRSN20N0 P9CPNVGN10N0 P9EPB02 P9AEPN201 P9AEPN202	3SB02-S21
Illuminated Pushbuttons				
E22TB2X4B	800EPL4 800E3DL3 800E3X01	ZA2BW14 ZA2BW06224	P9XPLRSDN12NADI	3SB1001-0LC01 3SB02-CBH 3SB1400-0C 3SB1400-2H
E22TB3X4A	800EPL3 800E3DL3 800E3X10	ZA2B213 AZ2B206124	P9XPLVSDN12NADI	3SB1001-0LE01 3SB02-CBH 3SB1400-0B 3SB1440-2H
E22TB9X4A	800EPL5 800E3DL3 800E3X10	ZA2BW15 ZA2BW06124	P9XPLASDN12NADI	3SB1001-0LD01 3SB02-CBH 3SB1400-0B 3SB1400-2H
E22TB2X10B	800EPL4 800E2RL5 800E3X01	ZA2BW14 ZA2BW062120	P9XPLRSB P9PRNVJ P9PDNVD	3SB1001-0LC01 3SB02-CBH 3SB1400-0C
E22TB3X10A	800EPL3 800E2RL5 800E3X10	ZA2BW13 ZA2BW061120	P9XPLVSD P9PRNVJ P9PDNVD	3SB02-UPR1P 3SB1910-0DE 3SB1400-0B
E22TB9X10A	800DPLE5 800E2RL5 800E3X10	ZA2BW15 ZA2B2061120	P9XPLASD P9PRNVJ P9PDNVD	3SB02-UPR1P 3SB1910-0DD 3SB1400-0B

E22 Series Cross-reference Tables

Pushbutton, Indicator Light, and Selector Switch Cross Reference (cont'd)				
Cutler-Hammer	Allen-Bradley	Telemecanique XB2B (chrome bezel) XA2B (black bezel)	GE C-2000	Siemens
Non-Illuminated Mushroom Pushbuttons				
E22LB2B	800EPM4 800E3LX01	ZA2BC4 ZA2BZ102	P9XEM4RNN20NO	3SB1000-1RC01 3SB02-CBH 3SB1400-0C
E22LLB2B	800EPMT4 800E3LX01	ZA2BS54 ZA2BZ102	P9XER4RAN20NO	3SB1000-1AC01 3SB02-CBH 3SB1400-0C
E22JPB2B	800EPMJ4 800E3LX01	ZA2BR4 ZA2BZ102	P9XEMGRN (60mm) P9B01VN	3SB1000-1VC01 (70MM) 3SB1400-0C
E22JLB2N8B	800EPMJP28 800E3LX01	NO EQUAL	NO EQUAL	NO EQUAL
E22JPLB2B	800EPMJP24 800E3LX01	ZA2BX4 ZA2BZ102	P9XET4RN1200	3SB1000-0KC01 (40mm) 3SB1400-0C
E22ASB106	800EP-MT4 800E-2LX01 800E-1P 800E-15YE112	XALJ174 No Nameplate +Yellow Cover	P9XER4RAN20NO P9EPB01 P9AEPNEN	3SB02-S13 No Nameplate + Yellow Cover
Indicating Lights				
<i>Use ZA2 or ZB2 for these indicating lights</i>				
E22HV2X4	800EPPL4 800E3DL3	ZA2BV04 ZA2BV624	P9XURRD0 BA9S24	N/A
E22HV3X4	800EPPL3 800E3DL3	ZA2BV03 ZA2BV624	P9XUGRD0 BA9S24	N/A
E22HV9X4	800EPPL5 800E3DL3	ZA2BV05 ZA2BV624	P9XUARD0 BA9S24	N/A
E22HV2X8	800EPPL4 800E3DL5	ZA2BV04 ZA2BV6120	B9XURRD0 BA9S130	N/A
E22HV3X8	800EPPL3 800E3DL5	ZA2BV03 ZA2BV6120	B9XUGRD0 BA9S130	N/A
E22HV9X8	800EPPL5 800E3DL5	ZA2BV05 ZA2BV6120	B9XUARD0 BA9S130	N/A
E22HL2X4	800EPPL4 800E3DL3R	ZA2BV043 ZA2BV624 DL1CJUS0244	B9XURRD0 080BA9S24LR	N/A
E22HL3X4	800EPPL3 800E3DL3G	ZA2BV033 ZA2BV624 DL1CJUS0243	B9XUGRD0 080BA9S24LG	N/A
E22HL9X4	800EPPL5 800E3DL3A	ZA2BV053 ZA2BV624 DL1CJUS0245	B9XUARD0 080BA9S24LA	N/A
E22HL2X8	800EPPL4 800E3DL5R	ZA2BV043 ZA2BV620 DL1CJUS1204	B9XURRD0 080BA9S120LR	N/A
E22HL3X8	800EPPL3 800E3DL5G	ZA2BV033 ZA2BV6120 DL1CJUS1203	B9XUGRD0 080BA9S120LG	N/A
E22HL9X8	800EPPL5 800E3DL5A	ZA2BV053 ZA2BV6120 DL1CJUS1205	B9XUARD0 080BA9S120LA	N/A

E22 Series Cross-reference Tables

Pushbutton, Indicator Light, and Selector Switch Cross Reference (cont'd)				
Cutler-Hammer	Allen-Bradley	Telemecanique XB2B (chrome bezel) XA2B (black bezel)	GE C-2000	Siemens
Indicating Lights (cont'd)				
		<i>Use ZA2 or ZB2 for these indicating lights</i>		
E22H2X11	800EPPL4 800E3TL5	ZA2BV04 ZA2BV3	P9XLRGJI	3SB1001-6CC06 3SB02-CBH 3SB1400-5M
E22H3X11	800EPPL3 800E3TL5	ZA2BV03 ZA2BVB3	P9XLGGJI	3SB1001-6CE06 3SB02-CBH 3SB1400-5M
E22H9X1	800EPPL5 800E3TL5	ZA2BV05 ZA2BV3	P9XLAGJI	3SB1001-6CD06 3SB02-CBH 3SB1400-5M
E22TB2X26	800EPL4 800E3TLT5X11	ZA2BW14 ZA2B2065120	P9XPLRSDN30NKJI	3SB02-UPR1P 3SB1910-ODC 3SB1400-0B
E22TP3X26	800EPL3 800E3TLT5X11	ZA2BW13 ZA2BW065120	P9XPLGSDN30NKJI	3SB02-UPR1P 3SB1910-ODE 3SB1400-0B
E22TB9X26	800DPLE5 800ETLT5X11	ZA2B215 ZA2BW065120	P9XPLASDN30NKJI	3SB02-UPR1P 3SB1910-ODD 3SB1400-0B
E22TB2X27	800EPL4 800E3TLT5X11	ZA2BW14 ZA2BW035	P9XPLRSDN30NHJI	3SB100-0QC01 3SB02-CBH 3SB1400-5M
E22TB3X27	800EPL3 800E3TLT5X11	ZA2BW13 ZA2BW035	P9XPLGSDN30NHJI	3SB1001-0QE01 3SB02-CBH 3SB1400-5M
E22TB9X27	800EPL5 800E3TLT5X11	ZA2BW15 ZA2BW035	P9XPLASDN30NHJI	3SB1001-0QA01 3SB02-CBH 3SB1400-5M
Selector Switches				
E22XB51A	800EPSM22 800E3LX10	ZA2BD2 ZA2BZ101	P9XSMD0N P9B10VN	3SB02-2MKBP 3SB1400-0B
E22XB51C	800EPSM22 800E3LX11	ZA2BD2 ZA2BZ105	P9XSMD0N P9B11VN	3SB02-2MKBP 3SB1400-0C
E22XBG1RR	800EPSM32 800E3LX20 800E3LX02	ZA2BD3 ZA2BZ103 ZA2BZ104	P9XSMZ0N P9B11VN	3SB02-3MKBP 3SB1400-0G 3SB1400-0H
E22KB53A	800EPKM2Z1 800E3LX11	ZA2BG4 ZA2BZ101	P9XSCD0K95 P9B10VN	3XB02-2MHC1P 3SB1400-0B
E22KB62A	800EPKR2Z1 800E3LX10	ZA2BG6 ZA2BZ101	P9XSCD0K95 P9B10VN	3SB02-2LHC1P 3SB1400-0B
E22KBG7RR	800EPKM3R1 800E3 800E3LX11	ZA2BG0 ZA2BZ103 ZA2BZ104	P9XSCZ0T95 (2) P9B11VN	3SB02-3MHC6P 3SB1400-0G 3SB1440-0H
E22KBG7D	800EPKM3R1 800E3LX10	ZA2BG0 ZA2BZ103	P9XSCU0K95	3SB02-3MHC2P 3SB1400-0G

E22 Series Cross-reference Tables

Pushbutton, Indicator Light, and Selector Switch Cross Reference (cont'd)				
Cutler-Hammer	Allen-Bradley	Telemecanique XB2B (chrome bezel) XA2B (black bezel)	GE C-2000	Siemens
Accessories				
E22B1	800E3X01	ZA2BZ102	P9B01VN	3SB1400-0C
E22B2	800E3X10	ZA2BZ101	P9B10VN	3SB1400-0B
E22NS33	800E13BE208	ZA2BZ32303	P9ACP2N202	P22MPS03
E22NS34	800E13BE212	ZA2BZ32304	P9ACP2N201	P22MPS04
E22NS19	800E13BE138	ZA2BZ32101 + custom text	P9ACP2N210	P22MPS28
E22NS11	800E13BE107	ZA2BZ32314	P9ACP2N205	P22MPS19
E22NS12	800E13BE110	ZA2BZ32308	P9ACP2N203	P22MPS17
E22NS50	800E13BE261	ZA2BZ32101+ custom text	P9ACP2N239	P22MPS81
E22NS15	800E13BE120	ZA2BZ32305	P9ACP2N214	P22MPS07
E22NS38	800E1BE253	ZA2BZ32101+ custom text	P9ACP2N231	P22MPS57
E22NS39	800E13BE127	ZA2BZ32101 + custom text	P9ACP2N243	P22MPS52
E22NS51	800E13BE128	ZA2BZ32387	P9ACP2N261	P22MPS80
E22NS41	800E13BE142	ZA2BZ32101 + custom text	P9ACP2N245	P22MPS65
E22NS81	800E13B	ZA2BZ32101 + custom text	P9ACP2NFEN	P22MPS38
E22NS82	800E13B	ZA2BZ32101 + custom text	P9ACP2NFEN	P22MPSBB + custom text
E22NS25	800E13BE166	ZA2BZ32311	P9ACP2R212	P22MPS01
E22NS26	800E13BE170	ZA2BZ32313	P9ACP2N206	P22MPS18
E22NS43	800E13BE171	ZA2BZ32101 + custom text	P9ACP2N234	P22MPS60
E22NS30	80013BE188	ZA2BZ32306	P9ACP2N215	P22MPS08
E22NS31	800E13BE193	ZA2BZ32334	P9ACP2N211	P22MPS06
E22NS35	800E13BE22	ZA2BZ32307	P9ACP2N204	P22MPS16
E22NS48	80013BE224	ZA2BZ32101 + custom text	P9ACP2N256	P22MPS61
E22NS13	800E13BE112	ZA2BZ32330	P9ACP2R229	P22MPS27
E22VA8	800E16Y	ZB2BY9303	080XTG802	3SX1348