

DIRECTSOFT32 PACKAGES

Programming software

- PC-PGMSW <--->
- PC-PGM-105 <--->
- PC-PGM-BRICK <--->
- PC-PGM-205 <--->
- PC-PGM-305 <--->

Overview

DirectSOFT32™ Programming Software single-user licenses have been designed to make PLC programming and machine monitoring easier than ever before. The 32-bit Windows-based package provides simple menu and icon choices that operate similarly to those found in most standard Windows packages. With DirectSOFT32 you can have the power of Windows on the factory floor.

For more information on DirectSOFT32 and to download a demo version, please visit our Web site at www.automationdirect.com. You can also view or download the Quick Start manual.

Which package is right for you?

The programming software packages share the same general features, but there are a couple of key differences:

- PC-PGMSW** programs all six CPU families (DL05, DL06, DL105, DL205, DL305 and DL405). If you're a system integrator or OEM who uses one or more of our product lines, then this package is the right choice.
- PC-PGM-105** programs the DL05 and DL105 CPUs only.
- PC-PGM-BRICK** programs the DL05, DL06 and DL105 CPUs only.
- PC-PGM-205** programs the DL205 CPUs only.
- PC-PGM-305** programs the DL-305 CPUs only.

Please note, you cannot upgrade the PC-PGM-305, PC-PGM-205, PC-PGM-105 or PC-PGM-BRICK packages to support any other product families.

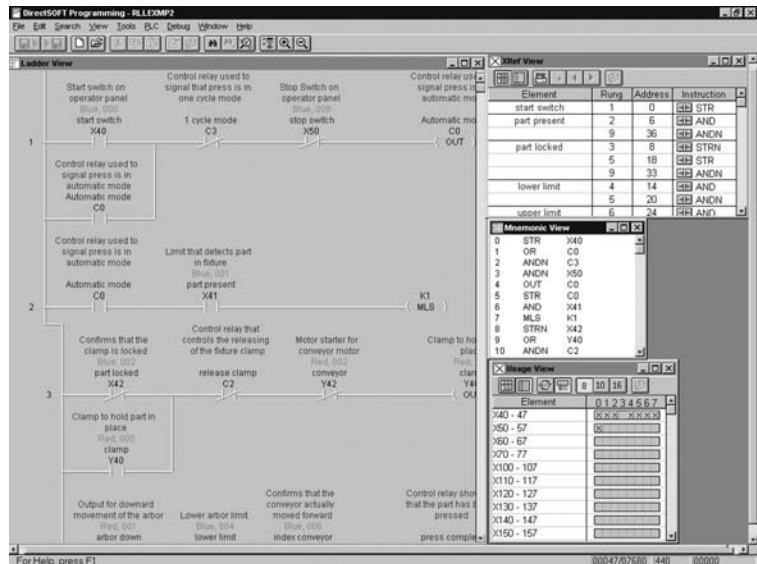

Number of users

The packages listed above are really "single-station" packages. That is, you can legally install them on only one computer. However, if there is only one person who primarily uses the computer (over 80% of the time), then you can install the software on a laptop, home office, or any other single backup computer.

If you need more flexibility, or you need to install multiple copies in many areas, then check out our Site Licenses.

Laptop/portable computers and off-site usage

Many of you may be using laptop computers for field service work. This is perfectly acceptable as long as it adheres to the guidelines described above.

Can I ship a copy to my customer?

No, except for a single backup copy, you cannot make, install, or distribute any additional copies. You can transfer the original copy (original CD, any applicable upgrades, and any documentation) with our written consent prior to the transfer.

Of course, this means you cannot legally keep a copy once you have transferred

the original. Some machine builders and OEMs are required to ship a copy of the PLC programming software with every machine. If this describes your situation, then you'll need our OEM license. The OEM license allows you to ship an inexpensive copy of the software with every machine you sell.

Maintenance releases

You can receive maintenance releases at no charge by downloading them from our Web site. These often include some minor feature enhancements along with software corrections.

Software upgrades

PC-RXX-U <--->

Any release that contains major feature enhancements will be subject to the normal upgrade charge in effect at that time. The DirectSOFT32 upgrade part number is PC-RXX-U, where XX is the latest release number.

Note: The upgrade will only update any packages that are already installed on your system.

1-800-633-0405

DIRECTSOFT32 FEATURES

Program editing features

- Full-screen Point and Click Editing with the mouse and icons
- Edit Tool Box contains icons and hot key equivalents for all elements
- Browsers help you find proper addresses, contacts, coils, and box instructions.
- Neat Win98/NT/2000/XP features (tear-off toolbars, ToolTips, long filenames, common file browsers)
- Project Information data with each project including creation and save dates, links, PLC type, project description and version, and company/department/programmer.
- On-screen Cross Reference
- On-screen Element Usage in groups of 8, 10, or 16 points per line
- Predefined aliases for common items, such as timer and counter current values.
- Enter your program with nicknames and assign them to address later
- Access V-memory (Data Registers) with fill-in-the-blank Memory Editor
- Easily cut and paste program elements, single rungs, or groups of rungs.
- Cut and paste rungs (with documentation) between programs
- Search for program elements by name, address, rung number, or instruction type
- Search for constants

Documentation features

- Import/export program mnemonics and rung comments to a single CVS file that does not have to be in **DirectSoft32** format
- Export (nickname, type, PLC address) to EZText/Touch in CVS format
- Grid-based documentation editor for easy access
- 16-character nicknames for addresses make troubleshooting and programming easier
- 16-character wiring information allows you to tie PLC addresses to panel wiring numbers
- 6-line x 18-character address description provides more detailed information about the program element
- Rung comments can be up to 20 lines of 69 characters each
- Cut, copy, and paste documentation between program elements
- Free-form program title page can be selected at time of printing
- Import/Export feature for documents

Printing features

- Print any available view, including ladders, charts, and mnemonics
- Print multiple columns
- Use zoom to enlarge or reduce print size
- Preview the printouts before you send them to the printer
- Create custom printouts by selecting exact items to include for each view
- Print program documentation, including nicknames, descriptions, rung comments, etc.
- Print program Cross Reference or Element Usage Table
- Print PLC V-memory or Data Register contents

Display and viewing features

- View program ladders
- View program mnemonics
- Stage view available for programs created with RLL^{PLUS} instruction
- Choose rung number or addresses for ladder view
- View multiple programs at the same time
- Use split screen to view different sections of the same program
- Use zoom to enlarge or reduce the screen area for better viewing
- Customize display colors for editing, unsaved changes, documentation, etc.

System setup features

- Set up PID loops with easy-to-use dialog boxes
- Set PLC communication parameters through PC ports, modems, or Ethernet
- Change PLC mode of operation
- Clear PLC memory by type or all
- Select or change retentive memory ranges
- Read PLC I/O configuration
- Change I/O configuration (if allowed by the PLC)
- View PLC firmware revisions
- Configure DV-1000

Online operation features

- Online help system with supported CPU instruction list
- DSLaunch as a central manager for all projects, links, and applications
- Automatically build and store communication links to the PLC, even using modems or Ethernet
- Visible indication of PLC communication link status
- Status mode provides visible power flow condition for program elements, current values for timers and counters, and current values for V-memory or Data Register locations. Even status for Drum steps, outputs, event and/or time transitions, etc.
- Custom configure Data View windows to monitor various elements
- Display nicknames in Data View
- Save and store Data View windows by name
- Choose data format for Data View Window display (BCD, binary, Hexadecimal, etc.)
- Choose status symbol (switch, text, etc.) for discrete points in Data View windows
- Change PLC values from Data View windows
- View multiple PLCs simultaneously (not available with OEM packages)

Maintenance and debugging

- Automatic error checking during program entry
- Program syntax check
- Monitor PLC scan time
- Perform PLC I/O diagnostics
- View PLC errors and/or user error messages
- Project back-up

DIRECTSOFT32 PROGRAMMING FOR PLCs

Programming versions

DirectSOFT32 Programming Software is available in several different packages. You can select the fully loaded package or one that is tailored just for a specific CPU family.

The fully-loaded version (PC-PGMSW) will program all of our *DirectLOGIC* PLCs, some GE Series One PLCs, and TI305/405 SIMATIC PLCs. Refer to the chart below to verify compatibility.

The single family *DirectSOFT32* packages were designed to provide a lower cost, more streamlined choice. The table below provides a listing of available single user versions.

OEM and site licenses

If you are an OEM supplier who needs to ship a copy of the software with the machines you have built, we offer several different OEM packages. Or, if you have a need for multiple copies at one location, there are several site license packages available. Refer to the table below to determine the right package for your application.

PLC compatibility

If you're using our *DirectLOGIC* products, then compatibility is not an issue. Make sure the package you choose supports the CPU you are using. Our software also supports many compatible products that were offered by previous vendors of the Koyo-designed PLCs. If you're buying the software to program a compatible CPU, check the following table to make sure your CPU is supported. (Sorry, but if your PLC is not shown, then it is not supported.)

Family	CPU	<i>DirectSOFT32</i> Programming PC-PGMSW	<i>DirectSOFT32</i> Programming Single Family	<i>DirectSOFT32</i> Site Licenses	<i>DirectSOFT32</i> OEM License	<i>DirectSOFT32</i> DSDData Server PC-DSDATA
DL05	Requires Rel. 2.4a or later	✓	PC-PGM-105 or PC-PGM-BRICK	✓		✓
DL06	Requires Rel. 4.0 or later	✓	PC-PGM-BRICK	✓		✓
DL105	F1-130** (requires Rel. 2.4a or later)	✓	PC-PGM-105 or PC-PGM-BRICK	✓		✓
DL205	DL-230	✓	PC-PGM-205	✓	PC-D20EM	✓
	D2-240	✓	PC-PGM-205	✓	PC-D20EM	✓
	D2-250 (D2-250-1 requires Rel. 4.0 or later)	✓	PC-PGM-205	✓	PC-D20EM	✓
	D2-260 (requires Rel. 4.0 or later)	✓	PC-PGM-205	✓	PC-D20EM	✓
DL305	D3-330*, D3-330P*	✓	PC-PGM-305	✓	PC-D30EM	✓
	D3-340	✓	PC-PGM-305	✓	PC-D30EM	✓
	D3-350 (requires Rel. 2.4a or later)	✓	PC-PGM-305	✓	PC-D30EM	✓
DL405	D4-430	✓		✓	PC-D40EM	✓
	D4-440**	✓		✓	PC-D40EM	✓
	D4-450** (requires Rel 2.4a or later)	✓		✓	PC-D40EM	✓
GE® Series 1	IC610CPU105*	✓	PC-PGM-305	✓	PC-D30EM	✓
	IC610CPU106*	✓	PC-PGM-305	✓	PC-D30EM	✓
TI305™/ SIMATIC® TI305™	325-07*, PPX:325-07*	✓	PC-PGM-305	✓	PC-D30EM	✓
	330-37*, PPX:330-37*	✓	PC-PGM-305	✓	PC-D30EM	✓
	325S-07* (or 325 with Stage Kit)	✓	PC-PGM-305	✓	PC-D30EM	✓
	330S-37*, PPX:330S-37*	✓	PC-PGM-305	✓	PC-D30EM	✓
	335-37, PPX:335-37	✓	PC-PGM-305	✓	PC-D30EM	✓
TI405™/ SIMATIC® TI405™	425-CPU, PPX:425-CPU**	✓		✓	PC-D40EM	✓
	PPX:430-CPU	✓		✓	PC-D40EM	✓
	435-CPU, PPX:435-CPU**	✓		✓	PC-D40EM	✓

*Requires Data Communications Unit (D3-232-DCU). ** Also DC versions. Note: In general, the compatible products listed offer similar features and are even identical in some cases. However, *DirectSOFT32* has not been completely tested with the compatible products. There may be some aspects of system operation that may not be supported, or that may not work the same as previous software packages.

DIRECTSOFT32 PROGRAMMING FOR PLCs

PC system compatibility

Following are the minimum system requirements for running *DirectSOFT32* on a PC:

- Pentium/Celeron CPU, 333 Mhz clock speed, CD-ROM for loading software
- Windows 98/2000/NT 4.0 or later, and all Windows XP versions (no DOS, OS/2, Macintosh, LINUX or UNIX versions, or 16-bit versions available)
- 32 MB free RAM and 11 MB free hard disk space
- At least one unused serial communications port
- Color SVGA monitor

NOTES:

Laptops: *DirectSOFT32* is perfectly suitable for use with laptop computers as long as they meet the requirements shown above. Most laptops can be ordered with a serial port as an option, which will allow a direct connection to our *DirectLOGIC* PLCs. If your laptop has a USB port, consider using our USB to serial adapter, USB-RS232 (minimum of DS3.0, build 80 required for support of USB & Windows XP). If your laptop has an Ethernet port and you are considering a DL205 or DL405 PLC, consider using the H*-ECOM Ethernet Communications Module to connect your PC to the PLC. (The D2-230 does not support the ECOM).

Monitors: Any size monitor will work, however, larger monitors enhance the features of *DirectSOFT32*. Also, we strongly recommend a color monitor. *DirectSOFT32* makes use of color to note certain conditions, such as program editing changes, error conditions, etc.

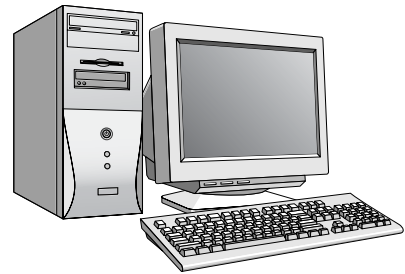

SOFTWARE

Connecting to *DirectLOGIC* PLCs

DL05 CPUs

Two built-in ports
Max. baud = 38.4 K

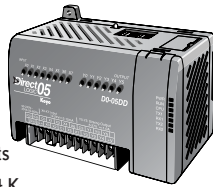

DL06 CPUs

Two built-in ports
Max. baud = 38.4 K

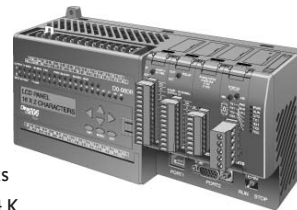

DL105 CPUs

One built-in port
Fixed baud = 9.6 K

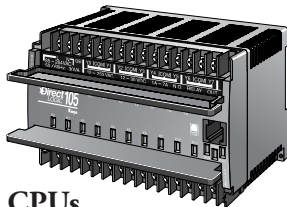

DL205 CPUs

One built-in port D2-230; fixed baud = 9.6 K
Two built-in ports D2-240; max. baud = 19.2 K
Two built-in ports D2-250(-1)/260 max. baud = 38.4 K

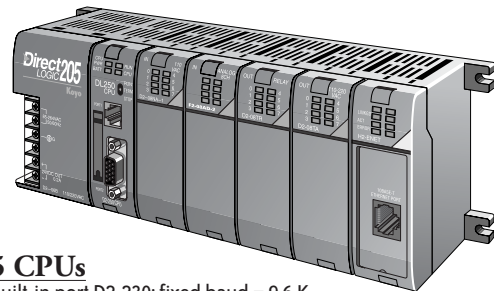

DL305 CPUs

D3-330 requires D3-232-DCU; fixed baud = 9.6 K
Two built-in ports D3-340/350; max. baud = 38.4 K

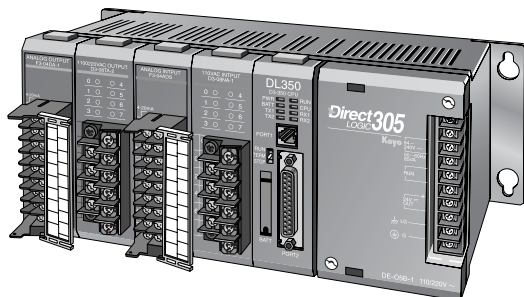

DL405 CPUs

Two built-in ports D4-430/440; max. baud = 19.2 K
Four built-in ports D4-450; max. baud = 38.4 K

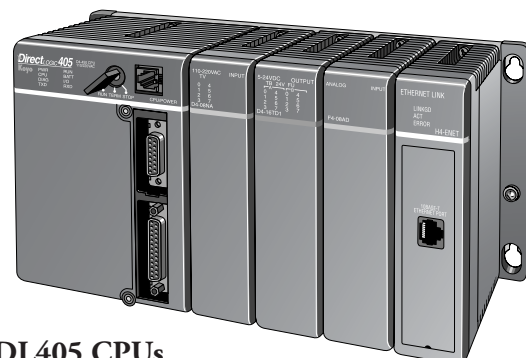

Or use an ECOM module in the DL205 (except D2-230) or DL405 local base to program over a high-speed Ethernet link.

PLC PROGRAMMING CABLES

Since CPUs provide many different communication port possibilities, it is helpful to know exactly which communications cable is required. Use the table below to choose the proper cable:

Family	CPU (or other device)	Port	Cable
DirectLOGIC DL05	All versions	Port 1	D2-DSCBL
		Port 2	D2-DSCBL
DirectLOGIC DL06	All versions	Port 1	D2-DSCBL
		Port 2	D2-DSCBL-1
DirectLOGIC DL105	F1-130 (all versions)	Only one	D2-DSCBL
DirectLOGIC DL205	D2-230	Only one	D2-DSCBL
	D2-240	Top port	D2-DSCBL
		Bottom port	D2-DSCBL
	D2-250(-1)	Top port	D2-DSCBL
		Bottom port	D2-DSCBL-1
	D2-260	Top port	D2-DSCBL
		Bottom port	D2-DSCBL-1
D2-DCM (module)	Only one	D3-DSCBL-2	
H2-ECOM /-F (modules)	Only one	**	
DirectLOGIC DL305	D3-330/D3-330P	Requires DCU*	D3-DSCBL-2
	D3-340	Top port	D3-DSCBL-1
		Bottom port	D3-DSCBL-1
	D3-350	Top port	D2-DSCBL
		Bottom port	D3-DSCBL-2
D3-DCM (module)	Only one	D3-DSCBL-2	
DirectLOGIC DL405	D4-430/D4-440	Top port (15-pin)	D4-DSCBL
		Bottom port (25-pin)	D3-DSCBL-2
	D4-450	Phone jack	D2-DSCBL
		Top port (15-pin)	D4-DSCBL
		Bottom port (25-pin)	D3-DSCBL-2
	D4-DCM (module)	Only one	D3-DSCBL-2
H4-ECOM (module)	Only one	**	
Slice I/O (module)	Only one	D4-DSCBL	
GE® Series 1	IC610CPU105/106	Requires DCU*	D3-DSCBL-2
TI305™/SIMATIC® TI305™	325-07, PPX:325-07	Requires DCU*	D3-DSCBL-2
	330-37, PPX:330-37	Requires DCU*	D3-DSCBL-2
	325S-07 (or 325 with stage kit)	Requires DCU*	D3-DSCBL-2
	330S-37, PPX:330S-37	Requires DCU*	D3-DSCBL-2
	335-37, PPX:335-37	Phone jack	D3-DSCBL-1
If DCU is used*		D3-DSCBL-2	
TI405™/SIMATIC® TI405™	425-CPU, PPX:425-CPU	If DCU is used*	D4-DSCBL
	N/A, PPX:430-CPU	Top port (15-pin)	D4-DSCBL
		Bottom port (25-pin)	D3-DSCBL-2
	435-CPU, PPX:435-CPU	Top port (15-pin)	D4-DSCBL
		Bottom port (25-pin)	D3-DSCBL-2
Smart slice	Only one	D4-DSCBL	

* Requires RS232 Data Communications Unit (D3-232-DCU). **Requires standard Ethernet twisted pair cable (HX-ECOM) or standard fiber optic cable (HX-ECOM-F).

PLC PROGRAMMING CABLES

Pin labeling conforms to IBM DTE and DCE standards

D2-DSCBL <---->

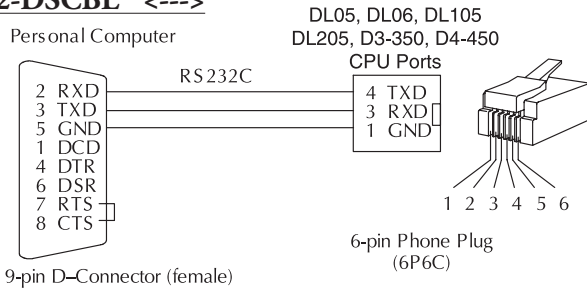

D2-DSCBL-1 <---->

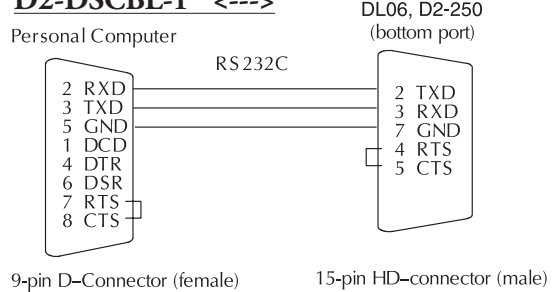

D3-DSCBL-1 <---->

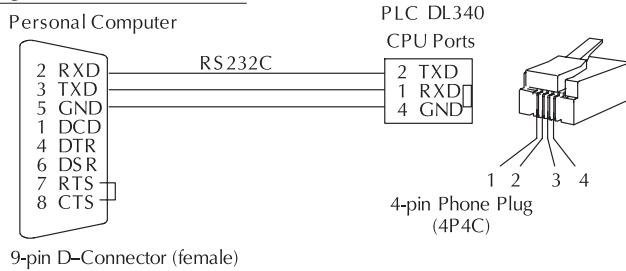

D3-DSCBL-2 <---->

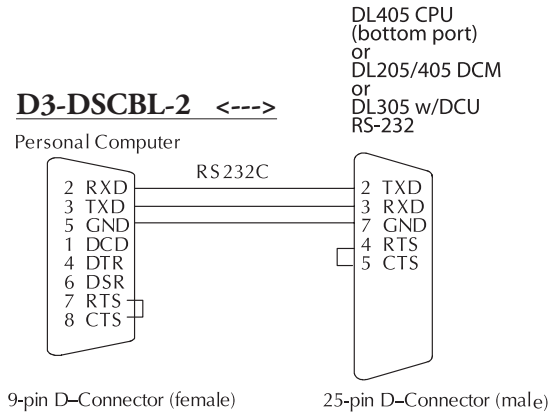

D4-DSCBL <---->

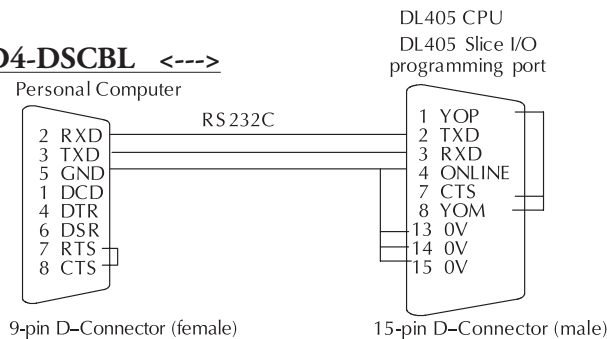

Straight-through Patch Cable (Ethernet)

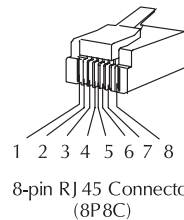
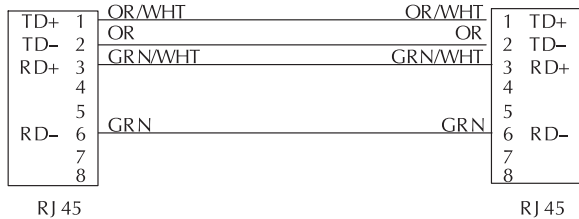

Crossover Cable (Ethernet)

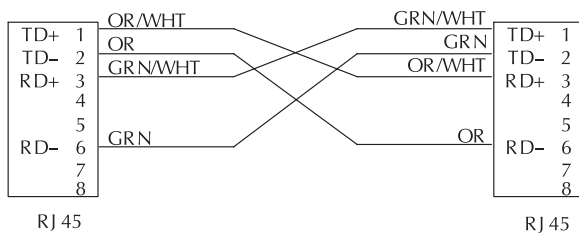

All Ethernet and ECOM patch cables should be Category 5, UTP Cable. The diagram illustrates the appropriate wire position in the RJ 45 connector.

DIRECTSOFT32 FUNCTIONS

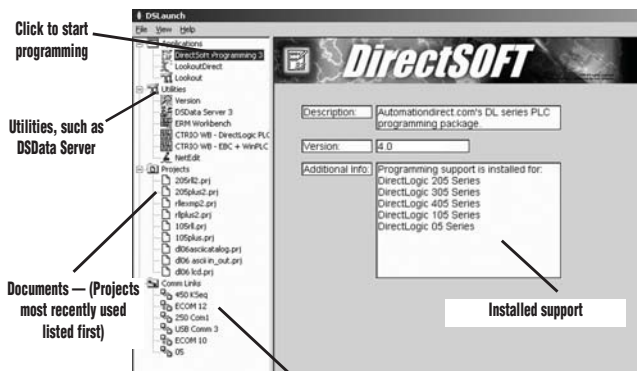

The Launch Window

The Launch Window is a centralized location to view not only all of your *DirectSOFT32* applications and projects, but also any additional applications such as HMI software, DSData Server, utilities, etc. This window is also used to create and manage PLC programs and the communications between your PC and the PLC.

Point and click editing

Once you have started a new project, there are a few different ways to start building your program. The Ladder Palette, which is floating and can be resized and repositioned anywhere on your desktop, contains most of the instructions. Simply click on the icon or use the Hot Key associated with that icon. Some instructions have to be accessed through one of the Browser icons. The Browsers contain all of the necessary information from various boxes, coils, and contacts.

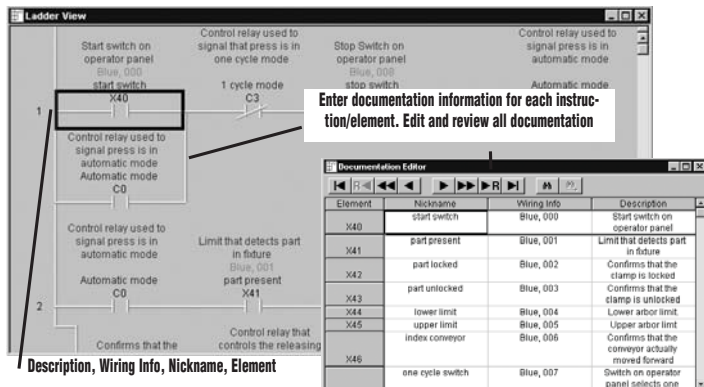
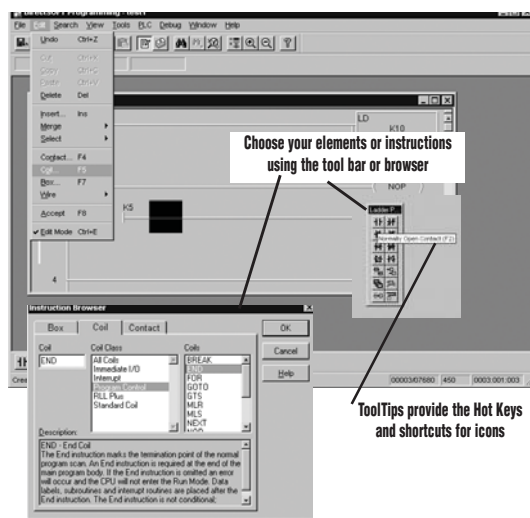

Documentation

Documentation is the text associated with the components and structure of your program. It helps to clarify the representation of elements by assigning four different fields: Description, Wiring Info, Nickname, and Element.

On-screen views

DirectSOFT32 allows you to keep different views to track program functions. You can have multiple windows open to view such things as all of the addresses used in the program, a Mnemonic view of the program instructions, and all of the instructions used.

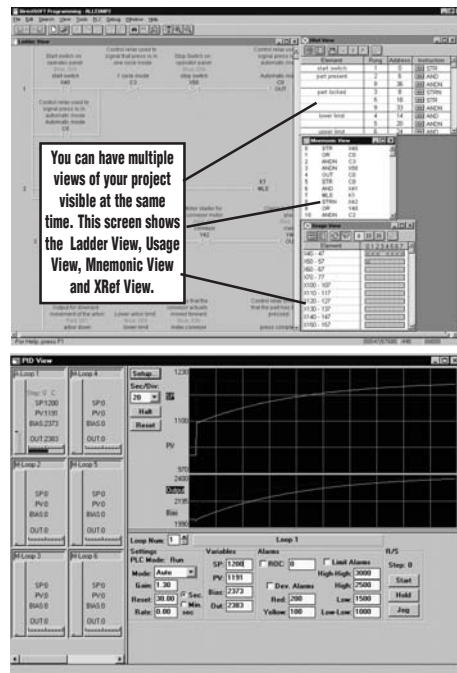

Support for drum instructions

If your PLC supports Drum instructions, you will like this feature of the programming software. Simply fill in the top of the drum with outputs and configure each step with an event and/or time-based element. Then click on the output boxes to choose the proper output states for each step and you are finished.

PID view

DirectSOFT32 offers an excellent PID feature. The loop and trending screens are very easy to configure. This feature has all of the views, trending, and tuning that you need to easily and successfully set up your PID loop.

DIRECTSOFT32 SITE AND OEM LICENSE

Site licenses

In some larger installations (or in educational institutions) there are occasions when you have several people who each need access to a copy of the programming software. A Site License package for *DirectSOFT32* Programming Software is available for those who need to install the software on multiple machines throughout a single location. The Site License package programs all *DirectLOGIC* families of PLCs (and many compatible PLCs).

Package contents

The Site License package contains one CD and one set of documentation. You can use this CD to install the software on the maximum number of PCs included in the site license. You can make copies of the documentation, or you can purchase additional copies.

Number of users

Each package is designed for a specific number of concurrent users. The license defines a 'user' as someone who uses the software more than 20% of their normal working hours. This means that even though you purchase a five-user license, you are actually allowed to have many other people who occasionally use the software. This is especially useful for technicians who only use the software for troubleshooting or maintenance on a random basis.

Can I ship a copy to my customer?

No, the Site License is not intended to allow you to ship copies of the software to your customers. If you need to do this, check out our OEM Licenses.

Portable computers and off-site usage

You can install the software on laptop machines for field work as long as their permanent residence remains at the licensed site. It is perfectly acceptable to allow your engineers or technicians to take computers to job sites or remote office for occasional use.

Upgrades

Maintenance releases are provided at no cost by ordering them or downloading them from the Web. The maintenance releases provide bug fixes, corrections, and any minor enhancements. Any release that contains major feature enhancements or significant new PLC support will be subject to the normal upgrade charge in effect at that time. For example, if you purchased a five-user license and later you see an advertisement that shows some exciting new features, rather than purchasing a new Site License, you would simply purchase five upgrade packages.

OEM licenses

An OEM license program for the *DirectSOFT32* Programming Software is also available. This program is designed to allow you to ship an inexpensive limited version of our powerful software with every machine you build.

Tailored packaging

Each package supports a single family of PLCs. For example, if you purchase the DL205 OEM License package (PC-D2OEM), you get support for the DL205 family of products only. The same is true for PC-D3OEM (*for DL305 family*) and PC-D4OEM (*for DL405 family*).

Note: It is not recommended that an OEM package be used for your development system due to the slightly reduced feature set and single family support. It is recommended that PC-PCMSW be purchased instead.

Package contents

The OEM License package one production CD with the OEM password utility and five complete sets of user documentation. The OEM is responsible for producing diskettes for the end users.

Extra copies

Once you have purchased the license, you can purchase extra copies at a discount. Extra copies can be tailored to the exact product you are using.

Password protection

With the password utility in the OEM packages, you can add your own password to each package that you send out. You can even completely restrict program editing capacity if necessary.

IMPORTANT! The OEM versions always allow the customer to at least view the program. The passwords only affect the ability to edit the program. These OEM packages are not a substitute for a CPU password, which is designed to minimize the risk of loss for proprietary program information.

Site license packages

We offer several different packages designed for specific numbers of users. This allows you to purchase a license that closely matches your needs without paying a high price.

Site license packages

Users	Order No.
5-user	PC-5U <--->
10-user	PC-10U <--->
25-user	PC-25U <--->
50-user	PC-50U <--->

Extra user copies

Users	Order No.
5-user	PC-5U-XC <--->
10-user	PC-10U-XC <--->
25-user	PC-25U-XC <--->
50-user	PC-50U-XC <--->

OEM license packages

Each OEM license provides support for a specific family of PLCs and comes with five complete packages.

OEM license part numbers

Family	Order No.
DL205	PC-D2OEM <--->
DL305	PC-D3OEM <--->
DL405	PC-D4OEM <--->

Extra user copies

Family	Order No.
DL205	PC-D2OEM-X <--->
DL305	PC-D3OEM-X <--->
DL405	PC-D4OEM-X <--->