

Screwless Double-Level Terminal Blocks

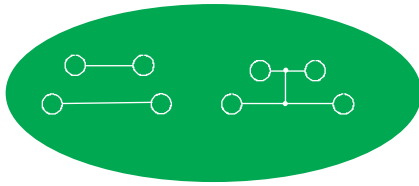

DN-QD12 DN-QD12X

Double-level terminal blocks offer twice the wiring density of feed-through blocks. The DN-QD12X version is supplied with an internal jumper to common all four of its connection points.

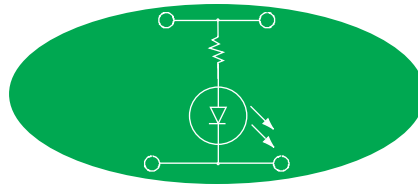

LED version

This style is available with LED indicator installed. The LED illuminates when voltage is present. The DN-QD12L2 version is for 12 - 24V AC/DC circuits, and includes current limiting elements.

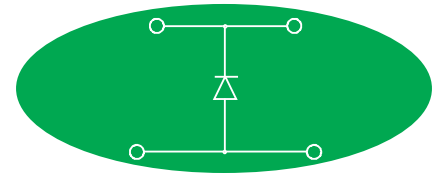

Diode version

Typically, an inductive load produces a spike (neg.-going) when it is turned off. These terminal blocks with built-in clamping diode help protect your PLC's output circuits.

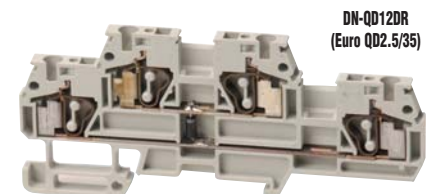
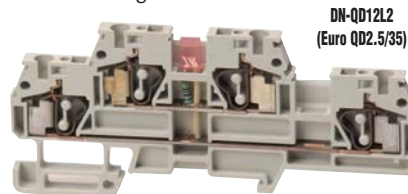
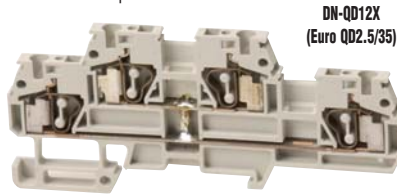

Double - Level Screwless Terminal Blocks

	Part Number	Price	Pcs/Pkg	Part Number	Price	Pcs/Pkg	Part Number	Price	Pcs/Pkg	Part Number	Price	Pcs/Pkg
Gray Terminal Block	DN-QD12	<--->	25	DN-QD12X	<--->	10	DN-QD12L2	<--->	10	DN-QD12DR	<--->	10
Blue Terminal Block	DN-QD12B	<--->	25	DN-QD12XB	<--->	10						
Description	Double - level screwless terminal blocks			Double - level screwless cross- connected terminal blocks			Double - level screwless terminal blocks with LED installed for visual circuit indication			Double - level screwless terminal blocks with diode installed for circuit protection		

Specifications

UL Approval	600V	20A	24-12AWG	600V	20A	24-12AWG	600V	20A	24-12AWG	600V	1A diode	24-12AWG
CSA Approval	600V	20A	24-12AWG	600V	20A	24-12AWG	600V	20A	24-12AWG	600V	1A diode	24-12AWG
VDE Approval	500V	24A	2.5mm ²	500V	24A	2.5mm ²	500V	24A	2.5mm ²	500V	1A diode	2.5mm ²
CE Conformity	IEC: IEC 947-7-1			IEC 947-7-1			IEC 947-7-1			IEC 947-7-1		
UL/CSA	UL/CSA: E179129			UL/CSA: E179129			UL/CSA: E179129			UL/CSA: E179129		
LED Voltage							12 - 24V AC/DC. 3.4 kΩ					
Wire Strip Length	0.47"(12mm)			0.47"(12mm)			0.47"(12mm)			0.47"(12mm)		
Density	60 pcs./ft. (200/m)			60 pcs./ft. (200/m)			60 pcs./ft. (200/m)			60 pcs./ft. (200/m)		
Operating Temperature	Ambient air temperature: -13°F to 104°F (-25°C to 40°C) Relative humidity: 50% max at 104°F (40°C); 90% max at 68°F (20°C)											

Accessories

Accessory	Part Number	Price	Pcs/Pkg
DIN Rail	DN-R35S1	<--->	10
	DN-R35S1-2	<--->	2
End Bracket	DN-EB35	<--->	50
	DN-EB35MN	<--->	20
	DN-EB35-A or DN-QEB35	various	50
	DN-EB35-A-10 or DN-QEB35-10	various	10
End Cover	DN-QDEC12	<--->	25
Jumper, 2 pole	DN-Q2J1210*	<--->	50
Marking Tags	DN-QL Series	<--->	500
Angled Support Bracket	DN-ASB1	<--->	50

For more information on accessories, see the DINnectors Accessories section of this chapter.

*Note: Jumpering and testing capability on bottom level only, for DN-QD12X, DN-QD12L2 and DN-QD12DR.

Dimensions: DN-QD12* Series

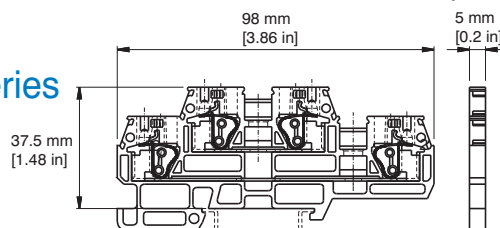

Screwless Terminal Blocks – Accessories

DIN rail

35 mm wide

These quality DIN rails are provided in one-meter lengths and two heights, 7.5 mm and 15 mm. The 7.5 mm-high rails are primarily used to mount terminal blocks, relays, timers and small PLCs such as the DL05, DL06, DL105, DL205, CLICK, and Productivity3000. The 15 mm-high rails are for mounting larger and heavier components such as contactors and larger PLCs.



	Part Number	Pcs/Pkg	Price/Pkg	Part Number	Pcs/Pkg	Price/Pkg
DIN Rail	DN-R35S1	10	<--->	DN-R35HS1	10	<--->
	DN-R35S1-2	2	<--->	DN-R35HS1-2	2	<--->
DINnectors Accessories Specifications						
Description	Steel, slotted, 3'3" (1m) length, 7.5mm high			Steel, slotted, 3'3" (1m) length, 15mm high		
Plating	silver-colored plating					
International Standards	CENELEC EN 50022, DIN 46277/3, RoHS			RoHS		
Approximate Ampacity	65 Amps			125 Amps		
Suggested Mounting Screw Type	M6			M6		

Dimensions

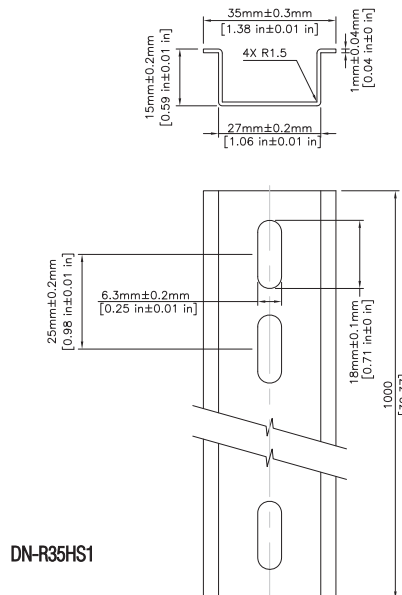
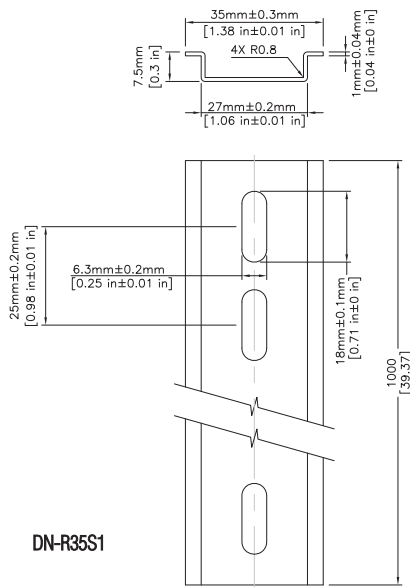

Angled support bracket

DN-ASB1 plated steel support brackets raise and tilt mounting rails for easier wiring.

Part Number	Pcs/Pkg	Price Each
DN-ASB1	50	<--->
<i>*Uses M6x1 metric fixing screw for mounting DIN rail to bracket; additional 5 mm unthreaded mounting hole available.</i>		

DN-ASB1

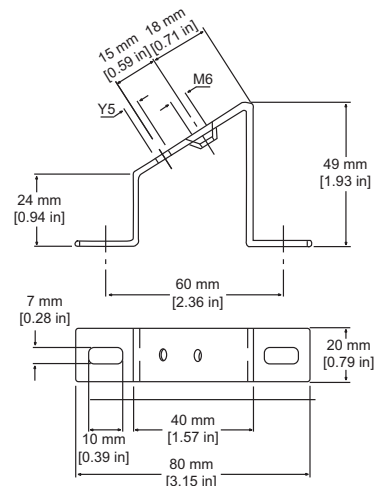

Screwless Terminal Blocks – Accessories

End Brackets

DN-xEB35x end brackets are designed to mount on 35 mm DIN rail, and are used to prevent components from sliding along the rail.

Part Number	Pcs/Pkg	Price Each
DN-EB35	50	<--->
DN-EB35MN	20	<--->
DN-EB35-A	50	<--->
DN-EB35-A-10	10	<--->
DN-QEB35	50	<--->
DN-QEB35-10	10	<--->

DN-QEB35

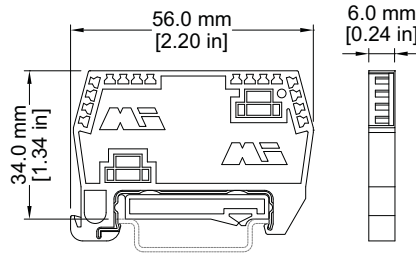

DN-EB35

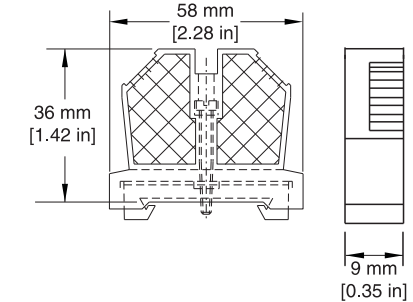

DN-EB35-A

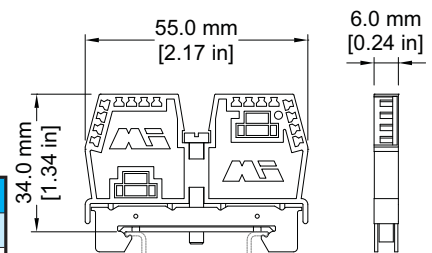

End Covers & Spacers

Certain end covers can be used with multiple terminal block parts to cover and insulate the open side, or to put more space between adjacent blocks.

End Covers for Screwless Dinnectors				
Part Number	Description	Dimensions LxHxB	Price	Pcs/Pkg
DN-QEC12	Gray end cover used with Screwless Feed-through DINnectors and Screwless Ground DINnectors	1.97" x 0.9" x 0.06" (50mm)x(23mm)x(1.5mm)	<--->	50
DN-QEC10	Gray end cover used with Screwless Feed-through DINnectors and Screwless Ground DINnectors	2.26" x 1.32" x 0.06" (57.4mm)x(33.6mm)x(1.5mm)	<--->	50
DN-QEC8	Gray end cover used with Screwless Feed-through DINnectors and Screwless Ground DINnectors	2.48" x 1.52" x 0.06" (63mm)x(38.5mm)x(1.5mm)	<--->	50
DN-QEC12-1-2	Gray end cover used with Screwless DINnectors series DN-Q12-1-2	2.70" x 1.12" x 0.06" (68.5mm)x(28.5mm)x(1.5mm)	<--->	25
DN-QEC12-2-2	Gray end cover used with Screwless DINnectors series DN-Q12-2-2	3.44" x 1.12" x 0.06" (87.5mm)x(28.5mm)x(1.5mm)	<--->	25
DN-QDEC12	Gray end cover used with Double Level Screwless DINnectors	3.86" x 1.46" x 0.06" (98mm)x(37mm)x(1.5mm)	<--->	25
DN-EMXM1EC1	Covers open side of TB DN-QEMXM1	as shown	<--->	25
DN-EMXM1EC2	covers closed side of TB DN-QEMXM1		<--->	25
DN-EMXM1SPA1	spacer for either side of TB DN-QEMXM1		<--->	25
DN-EMXDVEC1	covers open side of TB DN-QEMXDV		<--->	25
DN-EMXDVEC2	covers closed side of TB DN-QEMXDV		<--->	25
DN-EMXDVSPA1	spacer for either side of TB DN-QEMXDV		<--->	25

DN-QEC Series

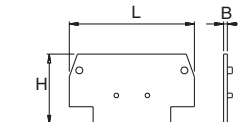

DN-QDEC Series

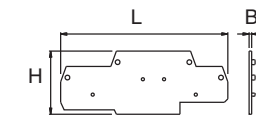

DN-EMXM1EC2

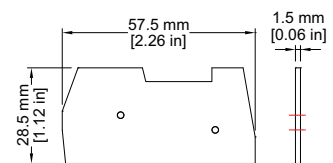

DN-EMXDVSPA1

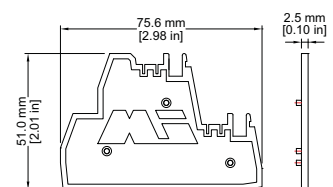

DN-EMDVEC1

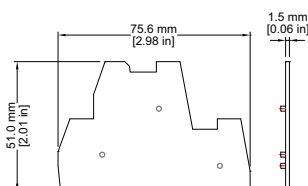

DN-EMDVEC2

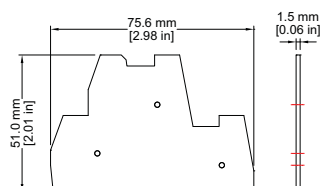

DN-EMXM1EC1

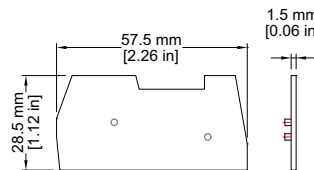

DN-EMXM1SPA1

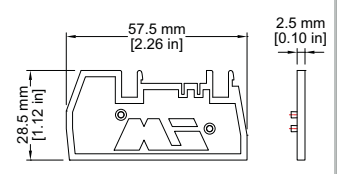

Screwless Terminal Blocks – Accessories

Jumper bar



DN-Q2J1210 shown

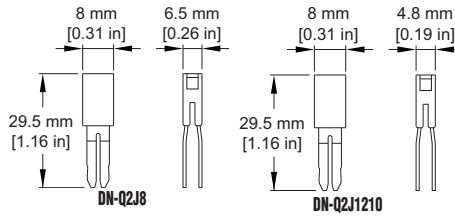

Jumper Bar for Screwless Dinnectors			
Part Number	Description	Price	Pcs/Pkg
DN-Q2J1210	Jumper bar (push-in style) for DN-Q12 and DN-Q10 screwless terminal blocks. Two insulated poles	<--->	50
DN-Q2J8	Jumper bar (push-in style) for DN-Q8 screwless terminal blocks. Two insulated poles	<--->	50

Note: Jumpers can be installed side-by-side to allow continuous termination.

Marking accessories

Marking tags

Marking Tags for Screwless Terminal Blocks			
Part Number	Marking Sequence	Price	Pcs/Pkg
DN-QL100	1-100 (50 labels/card, 10 cards/box)	<--->	500
DN-QL200	101-200 (50 labels/card, 10 cards/box)	<--->	500
DN-QL300	201-300 (50 labels/card, 10 cards/box)	<--->	500
DN-QL400	301-400 (50 labels/card, 10 cards/box)	<--->	500
DN-QL500	401-500 (50 labels/card, 10 cards/box)	<--->	500
DN-QLB	Blank Tags (50 labels/card, 10 cards/box)	<--->	500

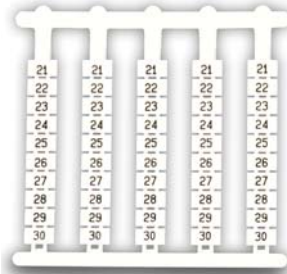

DN-QL100

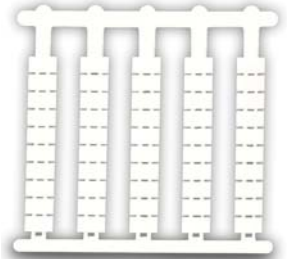

DN-QLB

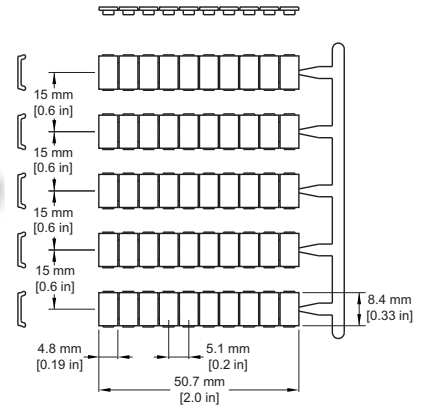

DN-EMLBL1



DN-EMLBL2



DN-EMLBL3

Part #	Description	For Use With	Pcs/Pkg	Price Each
DN-EMLBL1	Blank labels	DN-EMPEG1 pin protectors for DN-xEMXxx plug-in terminal blocks	100	<--->
DN-EMLBL2	Labels printed 1 – 12		100	<--->
DN-EMLBL3	Labels printed 13 – 24		100	<--->

Marking Pen – for terminal and wire marking tags

- Permanent
- Smudge-proof
- Waterproof
- Weatherproof
- Lightfast (won't fade)
- Dries in seconds (excellent for left-handed users)
- Dry-safe (pen can be left uncapped for days without drying out)
- Low odor ink

Part#	Description	Pcs/Pkg	Price Each
DN-MP	Indelible black ink marking pen	1	<--->



Marking pen

Screwless DINnectors Cross Reference

Allen-Bradley Part Number	Screwless DINnectors Part Number
1492-R4	DN-Q10
1492-R4-B	DN-Q10B
1492-R3	DN-Q12
1492-R3T	DN-Q12-1-2
1492-R3Q	DN-Q12-2-2
1492-R3-B	DN-Q12B
1492-R3T-B	DN-Q12B-1-2
1492-R3Q-B	DN-Q12B-2-2
1492-R6	DN-Q8
1492-R6-B	DN-Q8B
1492-RD3	DN-QD12
1492-RD3-B	DN-QD12B
1492-RD3C	DN-QD12X
1492-TC4	DN-QEC10
1492-RG4	DN-QG10
1492-RG3	DN-QG12
1492-RG6	DN-QG8
1492-SM5x9	DN-QL100
1492-SM5x9	DN-QLB
1492-RG3T	DN-QG12-1-2
1492-RG3Q	DN-QG12-2-2
1492-RKD3	DN-QKBD12

Wago Part Number	Screwless DINnectors Part Number
282-901	DN-Q10
282-904	DN-Q10B
280-901	DN-Q12
280-681	DN-Q12-1-2
280-833	DN-Q12-2-2
280-904	DN-Q12B
280-684	DN-Q12B-1-2
280-834	DN-Q12B-2-2
284-601	DN-Q8
284-604	DN-Q8B
281-619	DN-QD12
281-629	DN-QD12B
N/A	DN-QD12X
282-325	DN-QEC10
282-907	DN-QG10
281-907	DN-QG12
284-907	DN-QG8
N/A	DN-QL100
209-xxx	DN-QLB
279-687	DN-QG12-1-2
279-837	DN-QG12-2-2
280-870	DN-QKBD12

Phoenix Part Number	Screwless DINnectors Part Number
3031364	DN-Q10
3031377	DN-Q10B
3031212	DN-Q12
3031241	DN-Q12-1-2
3031306	DN-Q12-2-2
3031225	DN-Q12B
3031254	DN-Q12B-1-2
3031319	DN-Q12B-2-2
3031487	DN-Q8
3031490	DN-Q8B
3031270	DN-QD12
3031283	DN-QD12B
3031539	DN-QD12X
3030420	DN-QEC10
3031380	DN-QG10
3031238	DN-QG12
3031500	DN-QG8
1050211	DN-QL100
1050004	DN-QLB
3104013	DN-QG12-1-2
3031267	DN-QG12-2-2
3031322	DN-QKBD12

Weidmuller Part Number	Screwless DINnectors Part Number
163205	DN-Q10
163206	DN-Q10B
160851	DN-Q12
160854	DN-Q12-1-2
160857	DN-Q12-2-2
160852	DN-Q12B
160855	DN-Q12B-1-2
160858	DN-Q12B-2-2
160862	DN-Q8
160863	DN-Q8B
167430	DN-QD12
167863	DN-QD12B
168999	DN-QD12X
163209	DN-QEC10
163208	DN-QG10
160864	DN-QG12
160867	DN-QG8
161000	DN-QL100
161000	DN-QLB
160865	DN-QG12-1-2
160866	DN-QG12-2-2
160868	DN-QKBD12