

RHINO PSM24-BCM360S Battery Control Module

The battery control module, when combined with a PSM24 power supply, makes a perfect DC-UPS system by providing the means to charge and monitor an external lead acid battery. The power supply charges the connected battery and keeps it in a charged mode. Consequently, the output voltage of the system is equivalent to the battery voltage.

To avoid overcharging the battery, an external temperature sensor (sold separately) automatically adjusts the battery voltage to the required end of charge voltage. This configuration extends the battery life.



Battery Control Module					
Part Number	Price	Input	Input Power Max	Output Voltage Nom	*Output Power Max
PSM24-BCM360S (includes terminal plugs)	<--->	24 VDC power supply and 24 VDC battery	360 W	24 VDC	360 W

*reduce maximum output current by battery charging current.

General Specifications	
Operating Temperature	-25°C to +70°C max (-13°F to +158°F) 1.5%/K, derating above 40°C (104°F)
Electromagnetic Compatibility	In correspondence to connected units (no internal switching device)
Battery Protection	Over voltage, deep discharge, short-circuit and reverse connection (built-in fuse)
Status Signals	DC-OK input, DC-OK output, BAT OK (all relay contacts closed at status OK)
Rating per Relay Contact	30 VDC / 1.0 A max.
Dimensions	Same as model PSM24-090S (see dimensions page)
Remote Link Wire 0.5m	One cable included with PSM24-BCM360S module
Remote ON/OFF	By external contact: ON = J5.7 + J5.8 not shorted OFF = J5.7 + J5.8 shorted

Battery Control Module Function Diagram

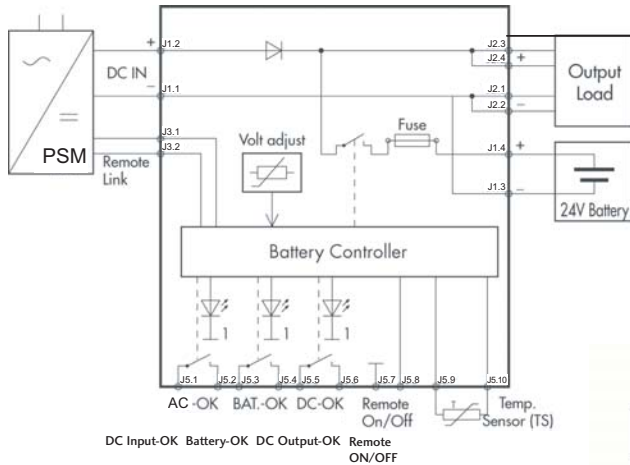

	J1	J2	J3	J4	J5	J6
Pin 1	- Vin (DC In)	GND (-)	S+	15 sec test	DC Input-OK Signal	PSM24-360S (factory setting)
Pin 2	+ Vin (DC In)	GND (-)	S-	Common	DC-OK Relay contact	PSM24-180S
Pin 3	- Bat in	Vout (+)	—	10 min test	Bat-OK Signal	PSM24-090S
Pin 4	+ Bat in	Vout (+)	—	—	Bat-OK Relay Contact	
Pin 5	—	—	—	—	DC Output OK Signal	
Pin 6	—	—	—	—	DC Output OK Relay Contact	
Pin 7	—	—	—	—	Remote ON/OFF	
Pin 8	—	—	—	—	Remote ON/OFF	
Pin 9	—	—	—	—	Temperature Sensing	
Pin 10	—	—	—	—	Temperature Sensing	

Battery Control Module Connector Positions

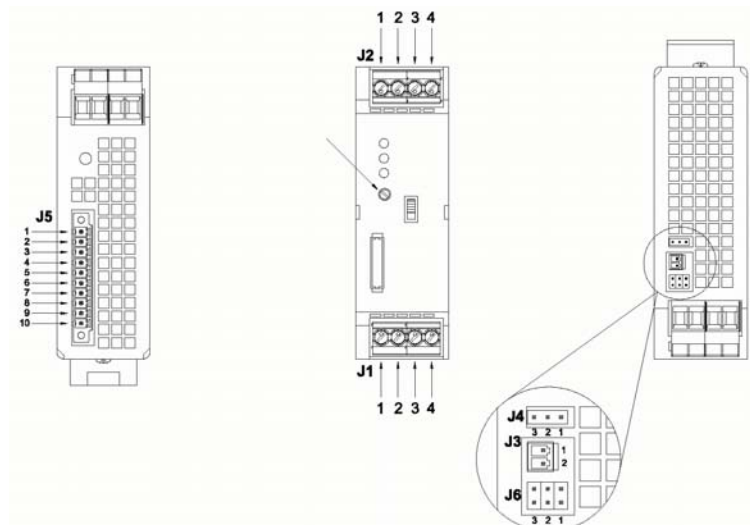

RHINO PSM Power Supplies - Accessories

A variety of accessories is available to complement the RHINO PSM power supplies. Choose panel mounting brackets and replacement plug kits from the table below, based on the size of the power supply. There is also a temperature sensor for the battery control module and replacement link cable for the redundancy and battery control modules.



Accessories		
Part Number	Price	Description
PSM-PANEL1	<--->	Panel mounting bracket. 1 bracket type A includes M4-screw (DIN 74-4fA) for 78W, 90W, 156W, 180W PSM power supplies
PSM-PANEL2	<--->	Panel mounting bracket. 2 brackets type A include M4-screws (DIN 74-4fA) for 360W, 600W PSM power supplies
PSM-PK1	<--->	Replacement plug kit for PSM series with 78W and 90W outputs
PSM-PK2	<--->	Replacement plug kit for PSM series with 156W, 180W and 360W outputs
PSM-PK3	<--->	Replacement plug kit for PSM series redundancy module
PSM-PK4	<--->	Replacement plug kit for PSM series buffer module
PSM-PK5	<--->	Replacement plug kit for PSM series battery control module
PSM-TS	<--->	Temperature sensor for PSM24-BCM360S battery control module
PSM-JC01	<--->	Replacement link cable for PSM series redundancy module PSM24-REM360S and battery control module PSM24-BCM360S

Mounting

PSM power supplies are designed for mounting on a DIN rail. Please allow minimum free space of 80 mm (3.15") above and below, and 50 mm (1.97") on each side of the power supply for air convection. To attach unit onto the DIN rail, hook the top part of clip on DIN rail, then push down and inward until you hear the clipping sound. To remove, pull the latch of the clip using an insulated flat-head screwdriver.

For wall or chassis mounting, use mounting brackets PSM-PANEL1 (for 78W to 180W PSM style power supplies) or PSM-PANEL2 (for 360W and 600W PSM power supplies). Remove the DIN clips and replace with the brackets. Use the countersink screws included with the wall mount kit to attach the brackets to the power supply.

To attach the power supply to the DIN rail

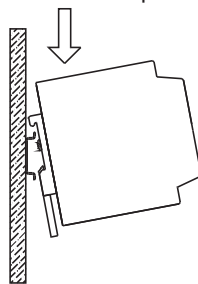

Fig. 2.1

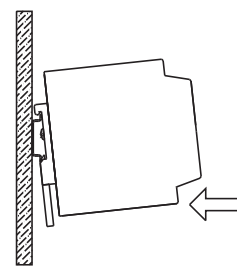

Fig. 2.2

To remove the power supply from DIN rail

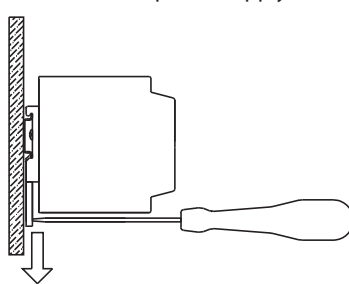

Fig. 2.3

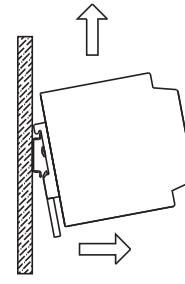
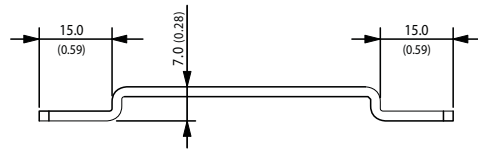
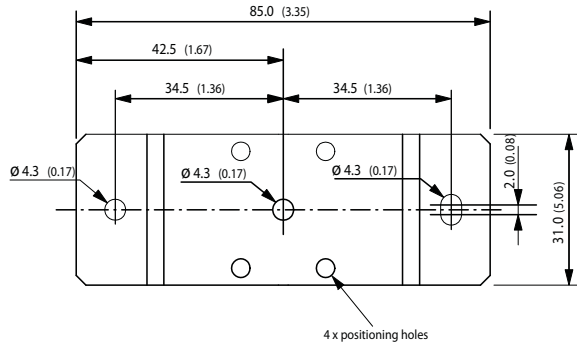

Fig. 2.4

RHINO PSM Panel Mounting Bracket Dimensions

PSM-PANEL1



Material: 2 mm Mild Steel
Tolerance: $\pm 0.1\text{mm}$ (± 0.004)

PSM12-078S, PSM24-090S

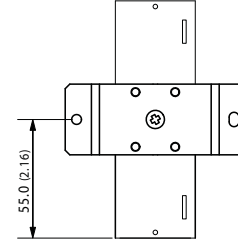

PSM12-156S, PSM24-180S

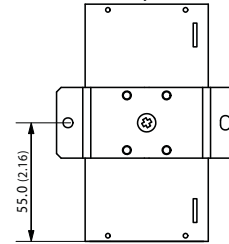

PSM-PANEL2

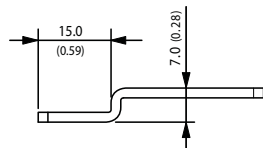
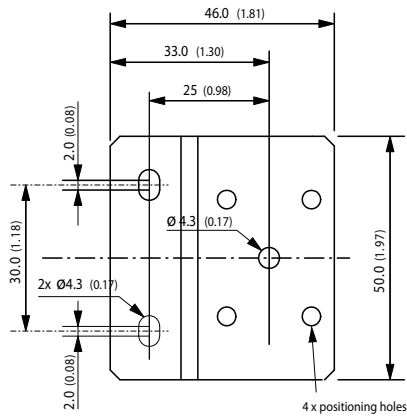

Material: 2 mm Mild Steel
Tolerance: $\pm 0.1\text{mm}$ (± 0.004)

Dimensions: [mm] () = Inch

PSM24-360S

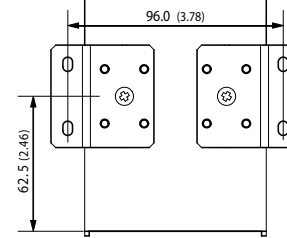

PSM24-600S

