

CPU SPECIFICATIONS AND OPERATION



CHAPTER 3

In This Chapter...

CPU Overview	3-2
CPU Specifications.....	3-3
Using Battery Backup	3-10
CPU Setup Information	3-11
CPU Operation	3-13
I/O Response Time	3-19
CPU Scan Time Considerations.....	3-21
PLC Numbering Systems.....	3-27
Memory Map.....	3-29
DL405 Aliases	3-36
X Input / Y Output Bit Map.....	3-37
Control Relay Bit Map	3-39
Timer and Counter Status Bit Map.....	3-43
Remote I/O Bit Map.....	3-44
Stage Control / Status Bit Map	3-48

CPU Overview

The Central Processing Unit is the heart of the control systems. Almost all system operations are controlled by the CPU, so it is very important to set up and install it correctly. This chapter provides the information needed to understand:

- The differences between the various models of CPUs
- The steps required to setup and install the CPU



General CPU Features

The D4-454 and D4-454DC-1 are modular CPUs which can be installed in, 4, 6, or 8 slot bases. All I/O modules in the DL405 family will work with both of the CPUs. The D4-454 CPUs offer a wide range of processing power and program instructions. Both offer RLL and Stage program instructions (See Chapter 5). Both CPUs have extensive internal diagnostics that can be monitored from the application program or from an operator interface.

CPU Features

The D4-454 has a maximum 30.8K program memory comprised of 15.5K of ladder memory and 15.3K of V-memory (data registers). It supports a maximum of 3584 points of local and local expansion I/O, and 4096 points of remote I/O. It includes an additional internal ARM Cortex M3/4 micro-controller for greater processing power. The D4-454 has 210 instructions, including drum timers, print function, floating point math, trigonometric functions and PID loop control for 16 loops.

The D4-454 has a total of four built-in communication ports. Port 0 has a RS232 interface and supports K Sequence, DirectNET (hex only, Slave only) protocols. Port 1 is RS232/RS422 interface and supports K Sequence, DirectNET, Non-sequence and MODBUS protocols. Port 2 has RS232 interface and supports DirectNET, K-Sequence, Non-sequence, and Modbus RTU protocols. Port 3 is RS422 interface and supports K-Sequence, DirectNet, Non-sequence and MODBUS protocols.

CPU Electrical Specifications

Specification	D4-454	D4-454DC-1
Input Voltage, Nominal	120 or 240 VAC	24 VDC
Input Voltage Range	85-132 VAC and 170-240 VAC	20-29 VDC
Input Voltage Ripple	N/A	< 10%
Inrush Current, maximum	20A	10A
Power Consumption, maximum	50 VA	38W
Voltage Withstand (dielectric strength)	1 minute at 1500 VAC between primary, secondary, field ground and run relay	
Insulation Resistance	> 10MΩ at 500 VDC	
Output Voltage, auxiliary power supply	20-28 VDC (24 nominal), ripple more than 1V P-P	
Output Current, auxiliary power supply	24 VDC @ 400 mA maximum	

CPU Specifications

General Specifications	
Feature	D4-454
Total Program Memory (words)	46.8K
Ladder Memory (words) built-in	31.5K
V-memory (words)	15.3K
Non-volatile V Memory (words)	No
Runtime Edit	Yes
Supports Override	Yes
RLL and RLLPLUS Programming	Yes
Direct SOFT (Programming for Windows)	Yes version 6.1 or later
Built-in Communication Ports	1 RJ12 RS232 1 15-pin RS232 1 25-pin RS232/RS422 1 25-pin RS422
Built-in Memory	Yes (M-RAM)
Number of Instructions Available	210
Control Relays	2048
Special Relays (system defined)	512
Stages in RLLPLUS	1024
V-memory (words)	15360
Timers	256
Counters	256
Immediate I/O	Yes
Interrupt Input	16 points
Subroutines	Yes
Drum Timers	Yes
Table Instructions	Yes
For/Next Loops	Yes
Math	Integer, Floating Point
ASCII	Yes
PID Loop Control, Built -in	Yes, 16 Loops
Time of Day Clock/Calendar	Yes
Internal Diagnostics	Yes
Password Security	Yes, multi-level
System Error Log	Yes
User Error Log	Yes
Battery Backup	D2-BAT-1 included

Local I/O and Local Expansion I/O	
Feature	D4-454
Available Bases	4 (CPU Base, 3 Expansion Bases)
CPU Base Total I/O	512
Local Expansion I/O per Base	512
Total Local I/O and Local Expansion I/O	2048
Local Addressable Discrete Input Points	1024
Local Addressable Discrete Output Points	1024
Local Addressable Analog Input Channels	512
Local Addressable Analog Output Channels	512
Slots per Base	4/6/8
Discrete I/O Module Point Density	8/12/16/32/64

Serial Remote I/O	
Feature	D4-454
Remote I/O Channels	3 (two D4-RM, vvvCPU Port 3)
Total Remote I/O	1536
Remote I/O per Channel	512
Remote I/O Slaves per Channel	7 (share 512 I/O points)
Remote I/O Distance	3300 ft (1000m)
Slots per Base	4/6/8
Discrete I/O Module Point Density	8/12/16/32/64

Ethernet Remote I/O	
Feature	D4-454
Channels per CPU using (H4-ERM100)	Limited by power budget
Slaves per Ethernet Remote Master	16 (H4-EBC)
Total Ethernet Remote I/O points	16384
Total Bases per Slave (H4-EBC)	4 (H4-EBC base, three D4-EX bases)
Slots per Base	4/6/8
Discrete I/O Module Point Density	8/12/16/32/64

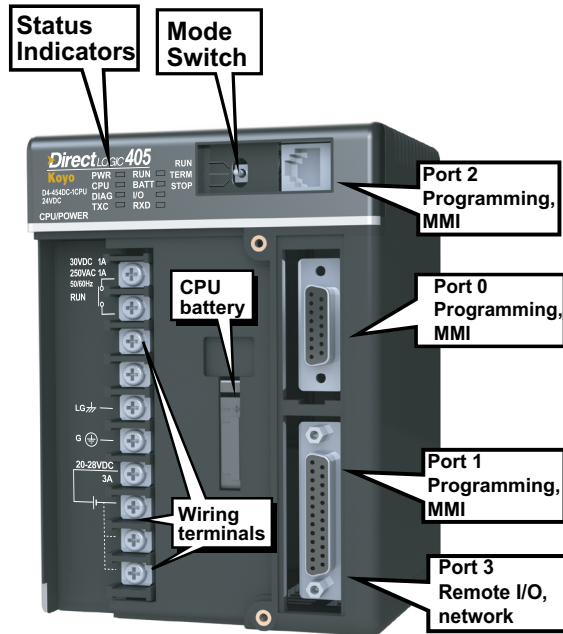

Toggle Switch Functions

The CPU mode switch on the D4-454 CPUs provides modes for enabling and disabling program changes in the CPU. Unless the mode switch is in the TERM position, RUN and STOP mode changes will not be allowed by any interface device, DirectSOFT programming software or operator interface. Programs may be viewed or monitored but no changes may be made. If the mode switch is in the TERM position and no program password is in effect, all operating modes as well as program access will be allowed through the connected programming or monitoring device.

Mode Switch	CPU Action
RUN (Run Program)	CPU is forced into the RUN mode if no errors are encountered. No changes are allowed by the attached programming / monitoring device.
TERM (Terminal)	RUN, PROGRAM and Debug modes are available. Mode and program changes are allowed by the programming / monitoring device.
STOP (Stop Program)	CPU is forced into the STOP mode. No changes are allowed by the programming / monitoring device.

Chapter 3: CPU Specifications and Operation

There are two ways to change the CPU mode.

- Use the CPU mode switch to select the operating mode.
- Place the CPU mode switch in the TERM position and use a programming device to change operating modes. In this position, you can change between Run and Program modes.

Status Indicators

The status indicator LEDs on the CPU front panels have specific functions which can help in programming and troubleshooting.

Indicator	Status	Meaning
PWR	ON	Power good
	OFF	Power failure
RUN	ON	CPU is in Run Mode
	OFF	CPU is in Stop or program Mode
	Flashing	CPU is in Firmware Upgrade Mode
CPU	ON	CPU self diagnostics error
	OFF	CPU self diagnostics good
BATT Note: Refer to page 3-8	ON	Low battery voltage (V7745.12 must be On)
	OFF	CPU battery voltage is good or disabled
DIAG	ON	CPU self diagnostics or local bus error
	OFF	CPU self diagnostics and local bus good
I/O	ON	I/O self diagnostics error
	OFF	I/O self diagnostics good
TXD	ON	Data is being transmitted by the CPU
	OFF	No data is being transmitted by the CPU
RXD	ON	Data is being received by the CPU
	OFF	No data is being received by the CPU

Communication Ports

The D4-454 CPUs provide four Serial communication ports.

Port 0 Specifications

The first port is located on the 15-pin D-shell connector. It is for general programming such as DirectSOFT, or operator interface connections. The operating parameters for Port 0 are permanently set to the values shown.

- 15-Pin Female D shell connector
- Protocols: K Sequence, DirectNET (Hex only, Slave only)
- RS232, non isolated, distance with 15m (approx. 50ft)
- 9600 baud, 8 data bits, 1 start, 1 stop bit, Odd parity
- Asynchronous, half-duplex, DTE
- Supports Firmware updates

Port 0 Pin Descriptions		
1	YOP	Sense connection between HPP and CPU
2	TXD	Transmit Data (RS232)
3	RXD	Receive Data (RS232)
4	ON-LINE	Request Communication (TTL)
5	ABNO	CPU error (TTL)
6	PRDY	CPU ready to communicate (TTL)
7	CTS	Clear to Send (RS232)
8	YOM	Sense connection between HPP and CPU
9	-	Not Used
10	LCBL	Sense cable connection (TTL)
11	5V2	5VDC for HPP logic
12	5V2	5VDC for LCD back-light
13	0V	Logic Ground
14	0V	Logic Ground
15	0V	Logic Ground

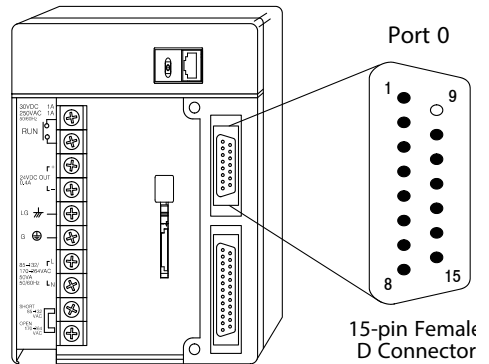

Port 1 Specifications

Port 1 is located on the 25-pin female D-shell connector. It is for general programming such as DirectSOFT, operator interfaces and networking. Port 1 provides additional features such as programmable baud rate, parity, ASCII/Hex mode and station addresses. Its RS422 signals support multi-drop networking and programming applications.

RS232 or RS422 is selected by cabling to the proper signal pin sets on the connector. Parity, ASCII/Hex mode and station address are selected by using DirectSOFT programming software.

- Protocols: K-Sequence, DirectNet, (master or slave only), Non-Sequence and MODBUS RTU (master or slave)
- RS232 / RS422, selectable address 1-90
- 2400 / 4800 / 9600 / 19200 / 38400 baud (default is 19200)
- 8 data bits, 1 start, 1 stop bit, Odd, Even or No parity (default is 8 data bits, 1 stop bit, Odd parity)
- Asynchronous, half-duplex, DTE
- Supports Firmware updates

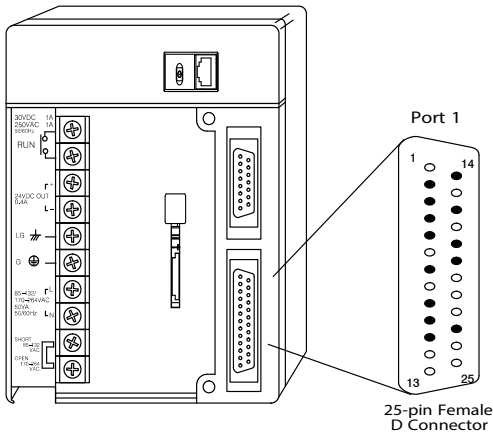

Port 1 Pin Descriptions		
1	–	Not Used
2	TXD	Transmit Data (RS232)
3	RXD	Receive Data (RS232)
4	RTS	Ready to Send (RS232)
5	CTS	Clear to Send (RS232)
6	–	Not Used
7	SG	Signal Ground (RS232/RS422)
8	–	(Port 3)
9	RXD+	Receive Data + (RS422)
10	RXD-	Receive Data – (RS422)
11	CTS+	Clear to Send + (RS422)
12	–	(Port 3)
13	–	(Port 3)
14	TXD+	Transmit Data –(RS422)
15	–	Not Used
16	TXD-	Transmit Data–(RS422)
17	–	Not Used
18	RTS-	Request to Send–(RS422)
19	RTS+	Request to Send + (RS422)
20	–	Not Used
21	–	Not Used
22	–	Not Used
23	CTS-	Clear to Send–(RS422)
24	–	(Port 3)
25	–	(Port 3)

Port 2 Specifications

The operating parameters for Port 2 on the D4-454 are configurable using DirectSOFT programming software on a programming device.

- 6-Pin Female modular (RJ12 phone jack) type connector
- Protocols: K-Sequence, DirectNET (master or slave only), Non sequence, Modbus RTU (master or slave)
- RS232, 2400 / 4800 / 9600 (default) / 19200 / 38400 baud
- Nodes (1–90)
- 8 data bits, one start, one stop; Odd, Even, or No parity; (default is 8 data bits, one stop; Odd parity)
- Supports Firmware updates



NOTE: The 5V pins are rated at 200mA maximum, primarily for use with some operator interfaces.

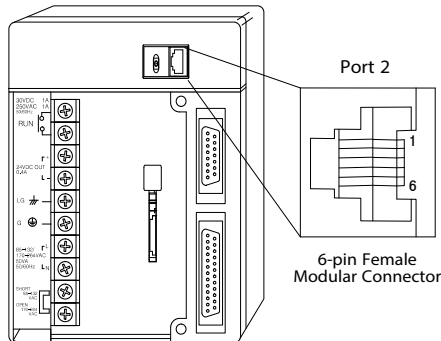

Port 2 Pin Descriptions		
1	0V	Power (–) connection (GND)
2	5V	Power (+) connection
3	RXD	Receive Data (RS232)
4	TXD	Transmit Data (RS232)
5	5V	Power (+) connection
6	0V	Power (–) connection (GND)

Port 3 Specifications

The operating parameters for Port 3 on the D4-454 are configurable using DirectSOFT on a programming device.

- 25 Pin Female modular D type connector
- Protocols: K-Sequence, DirectNET (master or slave) Non-sequence, Modbus RTU (master or slave)
- RS422, selectable address 1-90, 2400 / 4800 / 9600 (default) / 19200 / 38400 baud
- Nodes (1-90)
- 8 data bits (default), one start, one stop (default); Odd (default), Even, or No parity
- Supports Firmware updates

Port 3 Pin Descriptions		
1	–	Not Used
2	–	(port 1)
3	–	(port 1)
4	–	(port 1)
5	–	(port 1)
6	–	Not Used
7	SG	Signal Ground (RS422)
8	–	Not Used
9	–	(port 1)
10	–	(port 1)
11	–	(port 1)
12	TXD+	Transmit Data + (RS422)
13	TXD-	Transmit Data–(RS422)
14	–	(port 1)
15	–	Not Used
16	–	(port 1)
17	–	Not Used
18	–	(port 1)
19	–	(port 1)
20	–	Not Used
21	–	Not Used
22	–	Not Used
23	–	(port 1)
24	RXD+	Receive Data + (RS422)
25	RXD-	Receive Data–(RS422)

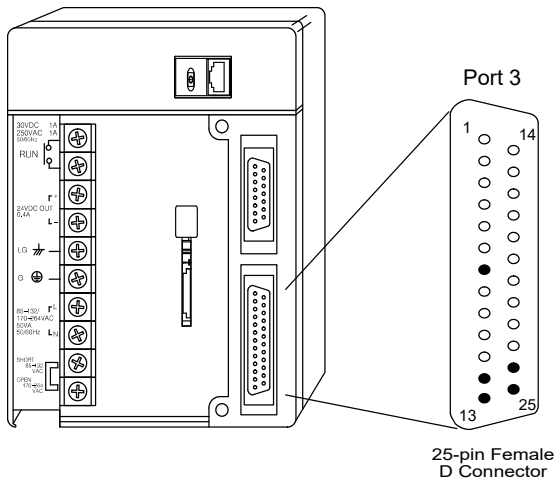

A drawing summarizing the pin locations and functions of ports 1 and 3 on the 25-pin connector is to the right. The two logical ports share two ground pins, but have separate communications data pins. When using both logical ports, you will probably have to make a custom connector which divides the signals in two for two separate cables.

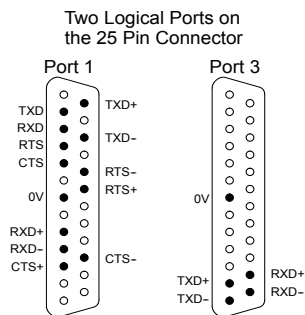

Using Battery Backup

A lithium battery is available to maintain the system RAM retentive memory when the system is without external power. Typical CPU battery life is five years, which includes PLC runtime and normal shutdown periods. However, consider installing a fresh battery if your battery has not been changed recently and the system will be shutdown for a period of more than ten days. The battery indicator will flash on and off at 2 Hz when a battery needs changing.



NOTE: Be sure to back up your V-memory and system parameters before replacing your CPU battery. You can do this by using DirectSOFT version 6.1 or later, to save the project, V-memory and system parameters to a personal computer. (File > Save Project). To prevent memory loss, the CPU battery can be changed while the system is powered up. If the CPU has been powered off you should power-up the CPU for at least 5 seconds prior to changing the battery. This ensures the capacitor used to maintain the necessary voltage levels for retaining memory is fully charged.

To install the D2-BAT-1 battery in the CPU:

- Press the retaining clip on the battery door and swing the battery door open (swings downward).
- Place the battery into the coin-type slot with the (+) or larger side out.
- Close the battery door making sure that it locks securely in place.
- Make a note of the date the battery was installed



WARNING: Do not attempt to recharge the battery or dispose of an old battery by fire. The battery may explode or release hazardous materials.

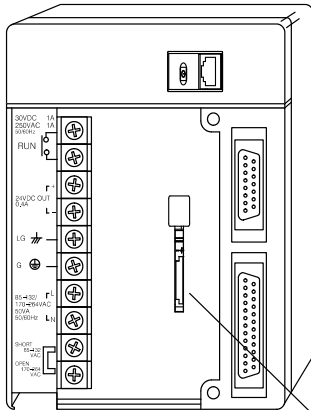

Battery

The battery backup is available immediately after the battery has been installed. The CPU indicator will blink if the battery is low (refer to table on page 3-5). Special Relay 43 (SP43) will also be set when the battery is enabled by setting bit 12 of V7633 (V7633.12). If the low battery feature is not desired, do not set bit V7633.12. The super capacitor will retain memory IF it is configured as retentive regardless of the state of V7633.12. The battery will do the same, but for a much longer time.

CPU Setup Information

Setting the Clock and Calendar

The D4-454 CPUs have a Clock / Calendar that can be used for many purposes. With DirectSOFT programming software you will use the PLC Setup menu options. There are two instructions that allow you change or modify the time and date from within the application program. Chapter 5 provides information on the DATE and TIME instructions that are used to establish the clock and calendar information.

The CPU uses the following format to display the date and time.

- Date—Year, Month, Date, Day of Week (0-6, Sunday through Saturday)
- Time—24 hour format, Hours, Minutes, Seconds

Variable/Fixed Scan Time Feature

The D4-454 CPU offers three types of scan time configurations:

- Variable—this is the standard scan time setting, in which the PLC scan is running as fast as the ladder program execution allows.
- Fixed—the scan time may be set to be constant, from 10ms to 9999ms. The operating system inserts a delay after each ladder scan to accomplish the requested fixed scan.
- Time—The PLC operates with a variable scan, but generates a watchdog timeout error if the scan exceeds the specified amount. You can use this to trap program execution errors, for example.

To select the desired D4-454 scan time option, use DirectSOFT and go online with the D4-454. Then select the PLC > Diagnostics > Scan Time > Setup. The three choices of Variable, Fixed, or Time appear.

Password Protection

The D4-454 CPUs have a password protection function using DirectSOFT. The password must be an eight character numeric (0–9) code. Once you’ve entered a password, you can remove it by entering all zeros (00000000). (This is the default from the factory.)

Multilevel Password The D4-454 CPUs also feature an intermediate level of protection that you can choose by making the first character of the password the character “A”. The remaining seven characters must be numeric (0–9). The intermediate password allows an Operator Interface to communicate with the processor, allowing V memory data changes and does NOT allow edits to the Ladder program.

Clearing an Existing Program

Before entering a new program, it’s a good idea to always clear ladder memory. You can clear an existing program from the CPU and once you are connected using the DirectSOFT programming software go to PLC > Clear Memory.



WARNING: Make sure you remember your password. If you forget your password you will not be able to access the CPU. The CPU must be returned to the factory to have the password (along with the ladder logic project) removed. It is the policy of AutomationDirect to require the memory of the PLC to be cleared along with the password.

Initializing System Memory

The D4-454 CPUs maintain system parameters in a memory area often referred to as the “scratchpad”. In some cases, you may make changes to the system setup that will be stored in system memory. For example, if you specify a range of Control Relays (CRs) as retentive, these changes are stored.

To initialize the “scratchpad”, you need to be connected with the D4-454, go to PLC > Setup > Initialize Scratchpad.



WARNING: You may never have to use this feature unless you want to clear any setup information that is stored in system memory. Usually you’ll only need to initialize the system memory if you are changing programs and the old program required a special system setup. You can usually change from program to program without ever initializing system memory.

Setting Retentive Memory Ranges

The D4-454 CPUs provide certain ranges of retentive memory by default. The default ranges are suitable for many applications, but you can change them if your application requires additional retentive ranges or no retentive ranges at all. The default settings are:

Memory Area	D4-454	
	Default Range	Available Range
Control Relays	C1000 – C3777	C0 – C3777
V-Memory	V400 – V37777	V0 – V37777
Timers	None by default	T0 – T377
Counters	CT0 – CT377	CT0 – CT377
Stages	None by default	S0 – S1777

CPU Operation

Achieving the proper control for your equipment or process requires a good understanding of how D4-454 CPUs control all aspects of system operation. The flow chart shows the main tasks of the CPU operating system. In this section, we will investigate four aspects of CPU operation:

- CPU Operating System—The CPU manages all aspects of system control.
- CPU Operating Modes — The three primary modes of operation are Program Mode, Run Mode, and Debug Mode.
- CPU Timing — The two important areas we discuss are the I/O response time and the CPU scan time.
- CPU Memory Map — The CPUs memory map shows the CPU addresses of various system resources, such as timers, counters, inputs, and outputs.

CPU Operating System

At power up, the CPU initializes the internal electronic hardware. Memory initialization starts with examining the retentive memory settings. In general, the contents of retentive memory are preserved, and non-retentive memory is initialized to zero (unless otherwise specified).

After the one-time power up tasks, the CPU begins the cyclical scan activity. The flowchart to the right shows how the tasks differ, based on the CPU mode and the existence of any errors. The “scan time” is defined as the average time around the task loop. Note that the CPU is always reading the inputs, even during program mode. This allows programming tools to monitor input status at any time.

The outputs are only updated in Run mode. In program mode, they are in the off state.

In Run Mode, the CPU executes the user ladder program. Immediately afterwards, any PID loops which are configured are executed. Then the CPU writes the output results of these two tasks to the appropriate output points.

Error detection has two levels. Non-fatal errors are reported, but the CPU remains in its current mode. If a fatal error occurs, the CPU is forced into program mode and the outputs go off.

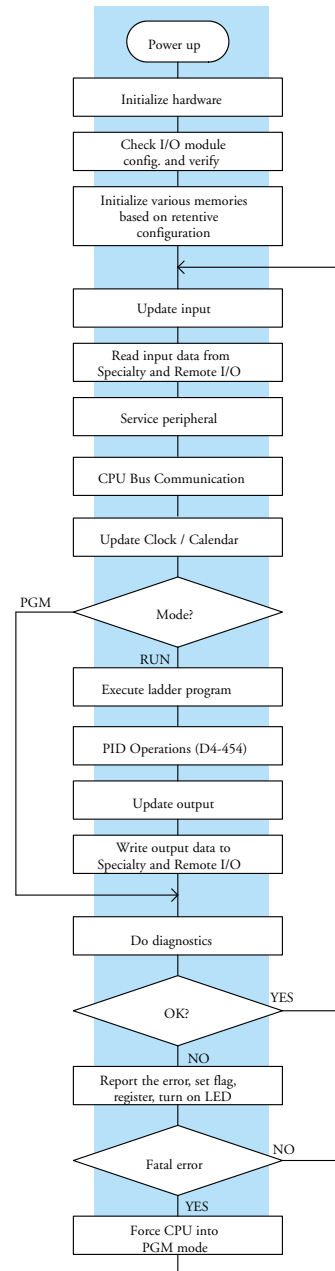

Program Mode Operation

In Program Mode the CPU does not execute the application program or update the output modules. The primary use for Program Mode is to enter or change an application program. You also use the program mode to set up CPU parameters, such as the network address, retentive memory areas, etc.

You can use the mode switch on the CPU to select Program Mode operation.

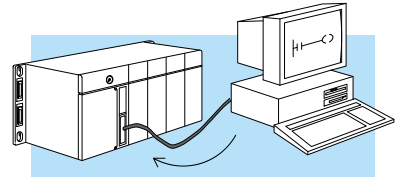

Download Program

Run Mode Operation

In Run Mode, the CPU executes the application program, does PID calculations for configured PID loops, and updates the I/O system. You can perform many operations during Run Mode. Some of these include:

- Monitor and change I/O point status
- Update timer / counter preset values
- Update Variable memory locations

Run Mode operation can be divided into several key areas. It is very important you understand how each of these areas of execution can affect the results of your application program solutions.

You can use the mode switch to select Run Mode operation.

You can also edit the program during Run Mode. The Run Mode Edits are not “bump-less.” Instead, the CPU maintains the outputs in their last state while it accepts the new program information. If an error is found in the new program, then the CPU will turn all the outputs off and enter the Program Mode.

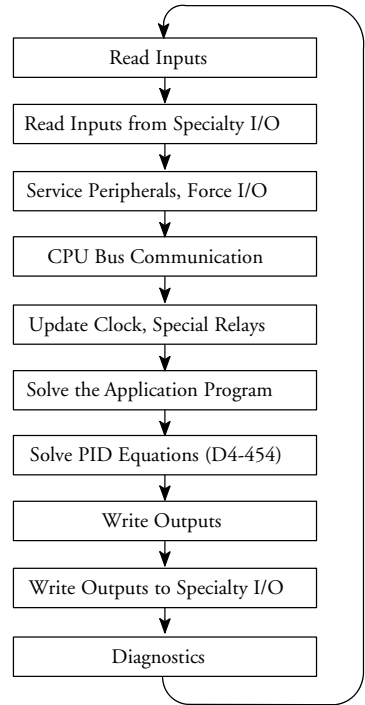

WARNING: Only authorized personnel fully familiar with all aspects of the application should make changes to the program. Changes during Run Mode become effective immediately. Make sure you thoroughly consider the impact of any changes to minimize the risk of personal injury or damage to equipment.

Read Inputs

The CPU reads the status of all inputs, then stores it in the image register. Input image register locations are designated with an X followed by a memory location. Image register data is used by the CPU when it solves the application program. Of course, an input may change after the CPU has read the inputs. Generally, the CPU scan time is measured in milliseconds. If you have an application that cannot wait until the next I/O update, you can use Immediate Instructions. These do not use the status of the input image register to solve the application program. The Immediate instructions immediately read the input status directly from I/O modules. However, this lengthens the program scan since the CPU has to read the I/O point status again. A complete list of the Immediate instructions is included in Chapter Five.

Read Inputs from Specialty and Remote I/O

After the CPU reads the inputs from the input modules, it reads any input point data from any Specialty modules that are installed, such as High Speed Counter modules, etc. This is also the portion of the scan that reads the input status from Remote I/O bases.



NOTE: *It may appear the Remote I/O point status is updated every scan. This is not quite true. The CPU will receive information from the Remote I/O Master module every scan, but the Remote Master may not have received an update from all the Remote slaves. Remember, the Remote I/O link is managed by the Remote Master, not the CPU.*

Service Peripherals and Force I/O

After the CPU reads the inputs from the input modules, it reads any attached peripheral devices. This is primarily a communications service for any attached devices. For example, it would read a programming device to see if any input, output, or other memory type status needs to be modified. There are two basic types of forcing available with the D4-454 CPUs:

- Forcing from a peripheral – not a permanent force, good only for one scan
- Bit Override – holds the I/O point (or other bit) in the current state. Valid bits are X, Y, C, T, CT, and S. (These memory types are discussed in more detail later in this chapter).

Regular Forcing — This type of forcing can temporarily change the status of a discrete bit. For example, you may want to force an input on, even though it is really off. This allows you to change the point status that was stored in the image register. This value will be valid until the image register location is written to during the next scan. This is primarily useful during testing situations when you need to force a bit on to trigger another event.

Bit Override — Bit override can be enabled on a point-by-point basis by using AUX 59 from the Handheld Programmer or, by a menu option from within DirectSOFT. Bit override basically disables any changes to the discrete point by the CPU. For example, if you enable bit override for X1, and X1 is off at the time, then the CPU will not change the state of X1. This means that even if X1 comes on, the CPU will not acknowledge the change. So, if you used X1 in the program, it would always be evaluated as Off in this case. Of course, if X1 was on when the bit override was enabled, then X1 would always be evaluated as On.

There is an advantage available when you use the bit override feature. The regular forcing is not disabled because the bit override is enabled. For example, if you enabled the Bit Override for Y0 and it was off at the time, then the CPU would not change the state of Y0.

However, you can still use a programming device to change the status. Now, if you use the programming device to force Y0 on, it will remain on and the CPU will not change the state of Y0. If you then force Y0 off, the CPU will maintain Y0 as off. The CPU will never update the point with the results from the application program or from the I/O update until the bit override is removed.

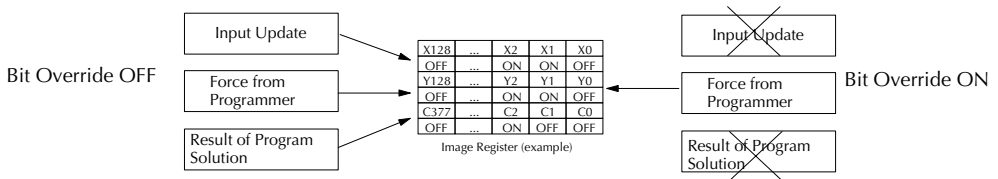

WARNING: Only authorized personnel fully familiar with all aspects of the application should make changes to the program. Changes during Run Mode become effective immediately. Make sure you thoroughly consider the impact of any changes to minimize the risk of personal injury or damage to equipment.

Update Special Relays and Special Registers

There are certain V-memory locations that contain register information. This portion of the execution cycle makes sure these locations get updated on every scan. Also, there are several different Special Relays, such as diagnostic relays, etc., that are also updated during this segment.

CPU Bus Communication

Many of the Specialty Modules, such as the Data Communications Module and the FACTS Co Processor modules, can transfer data to and from the CPU over the CPU bus on the backplane. This data is more than just standard I/O point status. This type of communications can only occur on the CPU (local) base. There is a portion of the execution cycle used to communicate with these modules. The CPU performs both read and write requests during this segment.

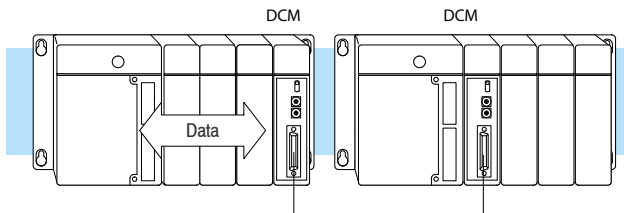

Update Clock, Special Relays and Special Registers

The D4-454 CPUs have an internal real-time clock and calendar timer which is accessible to the application program. Special V-memory locations hold this information. This portion of the execution cycle makes sure these locations get updated on every scan. Also, there are several different Special Relays, such as diagnostic relays, etc., that are also updated during this segment.

Solve Application Program

The CPU evaluates each instruction in the application program during this segment of the scan cycle. The instructions define the relationship between input conditions and the desired output responses.

The CPU begins with the first rung of the ladder program, evaluating it from left to right and from top to bottom. It continues rung by rung until it encounters the END coil instruction. At that point, a new image for the outputs is complete.

The CPU uses the output image register area to store the status of the desired action for the outputs. Output image register locations are designated with a Y followed by a memory location. The actual outputs are updated during the write outputs segment of the scan cycle. There are immediate output instructions available that will update the output points immediately instead of waiting until the write output segment. A complete list of the Immediate instructions is provided in Chapter 5.

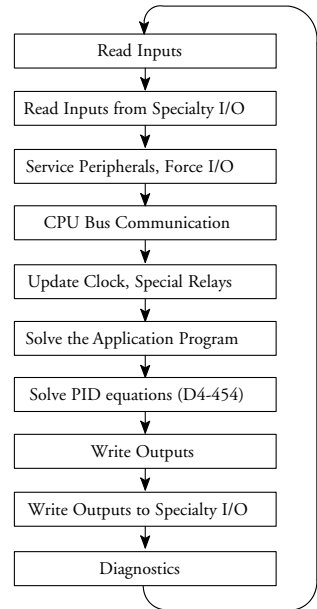
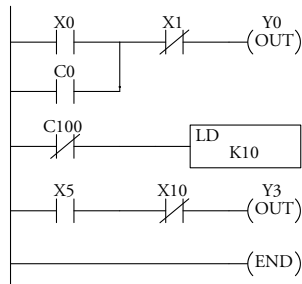

The internal control relays (C), the stages (S), the global relays (GY), and the variable memory (V) are also updated in this segment.

You may recall the CPU may have obtained and stored forcing information when it serviced the peripheral devices. If any I/O points or memory data have been forced, the output image register also contains this information.

Solve PID Loop Equations

The D4-454 CPUs can process up to 16 PID loops. The loop calculations are run as a separate task from the ladder program execution, immediately following it. Only loops which have been configured are calculated, and then only according to a built-in loop scheduler. The sample time (calculation interval) of each loop is programmable. Please refer to Chapter 8, PID Loop Operation, for more on the effects of PID loop calculation on the overall CPU scan time.

Write Outputs

Once the application program has solved the instruction logic and constructed the output image register, the CPU writes the contents of the output image register to the corresponding output points located in the local CPU base or the local expansion bases. Remember, the CPU also made sure any forcing operation changes were stored in the output image register, so the forced points get updated with the status specified earlier.

Write Outputs to Specialty and Remote I/O

After the CPU updates the outputs in the local and expansion bases, it sends the output point information that is required by any Specialty modules which are installed. For example, this is the portion of the scan that writes the output status from the image register to the Remote I/O racks



NOTE: It may appear the Remote I/O point status is updated every scan. This is not quite true. The CPU will send the information to the Remote I/O Master module every scan, but the Remote Master will updated the actual remote modules during the next communication sequence between the master and slave modules. Remember, the Remote I/O link communication is managed by the Remote Master, not the CPU.

Diagnostics

During this part of the scan, the CPU performs all system diagnostics and other tasks, such as:

- Calculating the scan time
- Updating special relays
- Resetting the watchdog timer

D4-454 CPUs automatically detect and report many different error conditions. Please refer to the Error Codes Appendix which contains a listing of the various error codes available with the DL405 system.

One of the more important diagnostic tasks is the scan time calculation and watchdog timer control. D4-454 CPUs have a “watchdog” timer that stores the maximum time allowed for the CPU to complete the solve application segment of the scan cycle. The default value set from the factory is 200ms. If this time is exceeded the CPU will enter the Program Mode, turn off all outputs, and report the error.

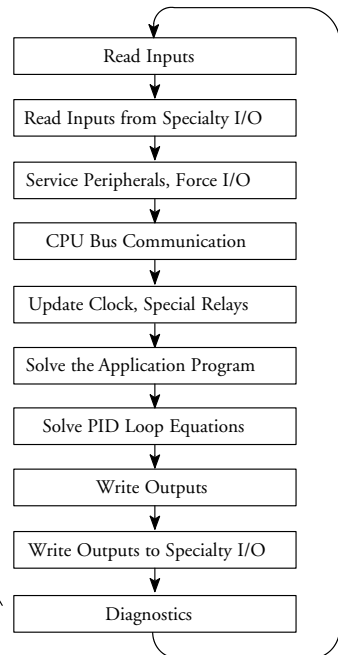

I/O Response Time

Is Timing Important for Your Application

I/O response time is the amount of time required for the control system to sense a change in an input point and update a corresponding output point. In the majority of applications, the CPU performs this task practically instantaneously. However, some applications do require extremely fast update times. There are four things that can affect the I/O response time.

- The point in the scan period when the field input changes states
- Input module Off to On delay time
- CPU scan time
- Output module Off to On delay time

Normal Minimum I/O Response

The I/O response time is shortest when the module senses the input change just before the Read Inputs portion of the execution cycle. In this case the input status is read, the application program is solved, and the output point gets updated. The following diagram shows an example of the timing for this situation.

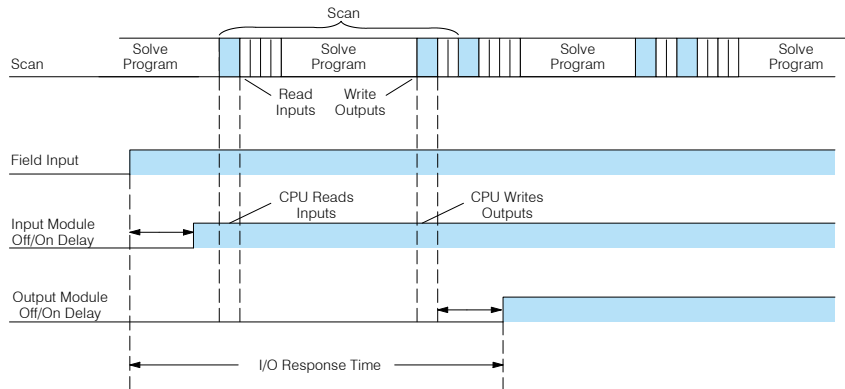

In this case, you can calculate the response time by simply adding the following items:

$$\text{Input Delay} + \text{Scan Time} + \text{Output Delay} = \text{Response Time}$$

Normal Minimum I/O Response

The I/O response time is longest when the modules senses the input change just after the Read Inputs portion of the execution cycle. In this case the new input status does not get read until the following scan. The following diagram shows an example of the timing for this situation.

In this case, you can calculate the response time by simply adding the following items.

$$\text{Input Delay} + (2 \times \text{Scan Time}) + \text{Output Delay} = \text{Response Time}$$

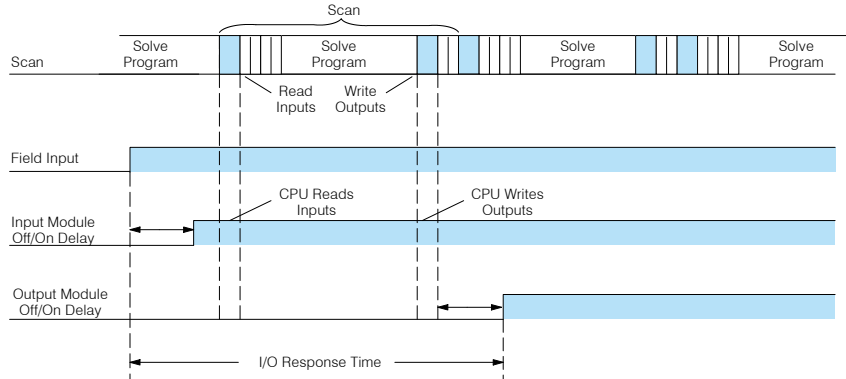

Improving Response Time

There are a few things you can do to help improve throughput.

- Choose instructions with faster execution times
- Use immediate I/O instructions (which update the I/O points during the ladder program execution segment)
- Choose modules that have faster response times

Immediate I/O instructions are probably the most useful technique. The following example shows immediate input and output instructions, and their effect.

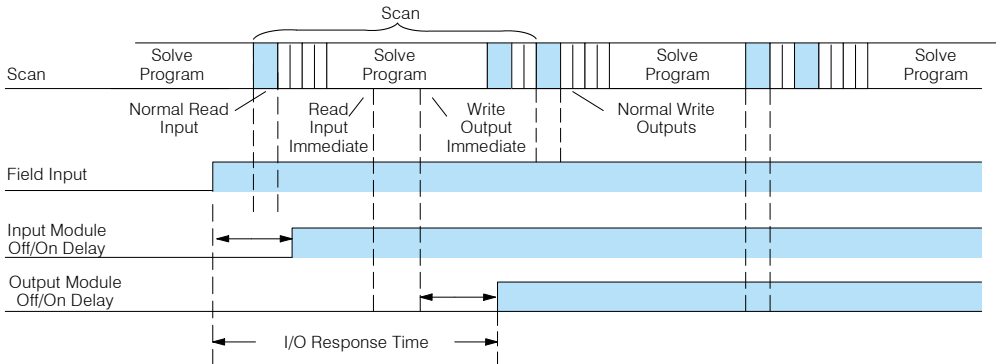

In this case, you can calculate the response time by simply adding the following items.

$$\text{Input Delay} + \text{Instruction Execution Time} + \text{Output Delay} = \text{Response Time}$$

The instruction execution time is calculated by adding the time for the immediate input instruction, the immediate output instruction, and all instructions in between.



NOTE: When the immediate instruction reads the current status from a module, it uses the results to solve that one instruction without updating the image register. Therefore, any regular instructions that follow will still use image register values. Any immediate instructions that follow will access the module again to update the status.

CPU Scan Time Considerations

The scan time covers all the cyclical tasks that are performed by the operating system. You can use DirectSOFT to display the minimum, maximum, and current scan times that have occurred since the previous Program Mode to Run Mode transition. This information can be very important when evaluating the performance of a system.

As we've shown previously there are several segments that make up the scan cycle. Each of these segments require a certain amount of time to complete. Of all the segments, the only one you really have the most control over is the amount of time it takes to execute the application program. This is because different instructions take different amounts of time to execute. So, if you think you need a faster scan, then you can try to choose faster instructions.

Your choice of I/O modules and system configuration, such as expansion or remote I/O, can also affect the scan time. However, these things are usually dictated by the application.

For example, if you have a need to count pulses at high rates of speed, then you'll probably have to use a High-Speed Counter module. Also, if you have I/O points that need to be located several hundred feet from the CPU, then you need remote I/O because it's much faster and cheaper to install a single remote I/O cable than it is to run all those wires for each individual I/O point.

The following paragraphs provide some of the general information on how much time some of the segments can require.

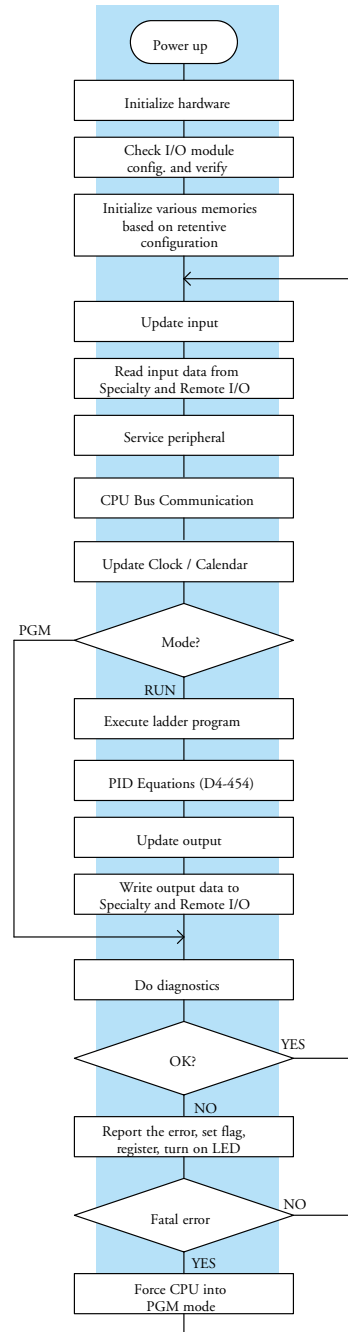

Initialization Process

The CPU performs an initialization task once the system power is on. The required time depends on system loading, such as the number of I/O modules installed. The initialization task is performed once at power-up, so it does not affect the scan time for the application program.

Initialization	
Minimum Time	1.9 Seconds
Maximum Time	3.3 Seconds

Reading Inputs

The time required to read the input status for the local and expansion input modules depends on the number of input points in the bases, and the number of input modules being used. The following table shows typical update times.

Timing Factors	
Overhead	20.0 μ s
Per input modules	13.0 μ s
Per input point	6.3 μ s

Update Clock/Calendar, Special Relays, Special Registers

For example, the time required for a D4-454 to read two 16-point input modules would be calculated as follows (Where NM is the number of modules and NI is the total number of input points.)

- Formula
- $\text{Time} = 20 \mu\text{s} + (13 \mu\text{s} \times \text{NM}) + (6.3 \mu\text{s} \times \text{NI})$

Example

- $\text{Time} = 20 \mu\text{s} + (13 \mu\text{s} \times 2) + (6.3 \mu\text{s} \times 16)$
- $\text{Time} = 146.8 \mu\text{s}$



NOTE: This information provides the amount of time the CPU spends reading the input status from the modules. Don't confuse this with the I/O response time that was discussed earlier.

Reading Inputs from Specialty I/O

During this portion of the cycle the CPU reads any input points associated with the following:

- Remote I/O
- Specialty Modules (such as High-Speed Counter, etc.)

The time required to read any input status from these modules depends on the number of modules and the number of input points.

For example, the time required for D4-454 to read two 32-point input modules (located in a Remote base) and the input points associated with a single High-Speed Counter module would be calculated as follows. (Where NM is the number of modules and NI is the number of input points in a module.)

Specialty Module	
Overhead	20.0 μ s
Per Module (with inputs)	13.0 μ s
Per input point	13.8 μ s

Remote Module	
Overhead	19.0 μ s
Per Module (with inputs)	62.0 μ s
Per input point	11.2 μ s

Remote I/O

- Formula
- Time = $19 \mu\text{s} + (62 \mu\text{s} \times \text{NM}) + (11.2 \mu\text{s} \times \text{NI})$

Example

- Time = $19\mu\text{s} + (62 \mu\text{s} \times 2) + (11.2 \mu\text{s} \times 32)$
- Time = 501.4 μ s

High Speed Counter

- Formula
- Time = $20 \mu\text{s} + (13 \mu\text{s} \times \text{NM}) + (13.8 \mu\text{s} \times \text{NI})$

Example

- Time = $20 \mu\text{s} + (13 \mu\text{s} \times 2) + (13.8 \mu\text{s} \times 16)$
- Time = 266.8 μ s

$$\text{Total Time} = 501.4 \mu\text{s} + 266.8 \mu\text{s} = 768.2 \mu\text{s}$$

Service Peripherals

Communication request can occur at any time during the scan, but the CPU only “logs” the requests for service until the Service Peripherals portion of the scan. (The CPU does not spend any time on this if there are no peripherals connected.)

To Log Request (anytime)	D4-454	
Nothing Connected	Min. & Max.	0 μ s
Port 0	Send Min. / Max.	38 / 38 μ s
	Rec. Min. / Max.	45 / 45 μ s
Port 1	Send Min. / Max.	41 / 48 μ s
	Rec. Min. / Max.	47 / 59 μ s
Port 2	Send Min. / Max.	41 / 48 μ s
	Rec. Min. / Max.	47 / 59 μ s
Port 3	Send Min. / Max.	38 / 38 μ s
	Rec. Min. / Max.	45 / 45 μ s

To Service Request	D4-454
Minimum	96 μ s
Run Mode Max.	160 ms
Program Mode Max.	11.2 Second

During the Service Peripherals portion of the scan, the CPU analyzes the communications request and responds as appropriate. The amount of time required to service the peripherals depends on the content of the request.

CPU Bus Communications

Some specialty modules can also communicate directly with the CPU via the CPU Bus. During this portion of the cycle the CPU completes any CPU Bus Communications. The actual time required depends on the type of modules installed and the type of request being processed.



NOTE: Some specialty modules can have a considerable impact on the CPU scan time. If timing is critical in your application, consult the module documentation for any information concerning the impact on the scan time.

Update Clock/Calendar, Special Relays, Special Registers

The clock, calendar, and special relays are updated and loaded into special V-memory locations during this time. This update is performed during both RUN and Program modes.

Modes		D4-454
Program Mode	Minimum	12.0 μ s
	Maximum	12.0 μ s
Run Mode	Minimum	22.0 μ s
	Maximum	29.0 μ s

Writing Outputs

The time required to write the output status for the local and expansion I/O modules depends on the number of output points that are in these bases and the number of output modules being used. The following table shows typical update times required by the CPU.

Timing Factors	D4-454
Overhead	15.0 μ s
Per output module	13.0 μ s
Per output point	14.1 μ s

For example, the time required for a D4-454 to write data for two 32-point output modules would be calculated as follows (where NM is the number of modules and NO is the number of output points in a module).

- Formula
- $\text{Time} = 15\mu\text{s} + (13\mu\text{s} \times \text{NM}) + (14.1\mu\text{s} \times \text{NI})$

Example

- $\text{Time} = 15\mu\text{s} + (13\mu\text{s} \times 2) + (14.1\mu\text{s} \times 32)$
- $\text{Time} = 492.2\mu\text{s}$

Writing Outputs to Specialty I/O

During this portion of the cycle the CPU writes any output points associated with the following:

- Remote I/O
- Specialty Modules (such as High-Speed Counter, etc.)

The time required to write any output image register data to these modules depends on the number of modules and the number of output points.

Specialty Modules	D4-454
Overhead	18.0 μ s
Per module (with outputs)	13.0 μ s
Per output point	14.1 μ s
Remote Modules	D4-454
Overhead	15.0 μ s
Per module (with outputs)	54.0 μ s
Per output point	13.9 μ s

For example, the time required for D4-454 to write two 32-point output modules (located in a Remote base) and the output points associated with a single High-Speed Counter module would be calculated as follows. (Where NM is the number of modules and NI is the number of output points in a module.)

Remote I/O

- Formula
- Time = $15\mu\text{s} + (54\mu\text{s} \times \text{NM}) + (13.9 \mu\text{s} \times \text{NI})$

Example

- Time = $15\mu\text{s} + (54\mu\text{s} \times 2) + (13.9 \mu\text{s} \times 32)$
- Time = 567.8 μ s

High Speed Counter

- Formula
- Time = $18\mu\text{s} + (13\mu\text{s} \times \text{NM}) + (14.1 \mu\text{s} \times \text{NI})$

Example

- Time = $18\mu\text{s} + (13\mu\text{s} \times 2) + (14.1 \mu\text{s} \times 16)$
- Time = 269.6 μ s



NOTE: The total time is the actual time required for the CPU to update these outputs. This does not include any additional time that is required for the CPU to actually service the particular specialty modules.

Diagnostics

The D4-454 CPU performs many types of system diagnostics. The amount of time required depends on many things, such as the number of I/O modules installed, etc. The following table shows the minimum and maximum times that can be expected.

Diagnostic Time	D4-454
Minimum	282.0 μ s
Maximum	398.0 μ s

Application Program Execution

The CPU processes the program from the top (address 0) to the END instruction. The CPU executes the program left to right and top to bottom. As each rung is evaluated the appropriate image register or memory location is updated.

The time required to solve the application program depends on the type and number of instructions used, and the amount of execution overhead.

You can add the execution times for all the instructions in your program to find the total program execution time.

For example, the execution time for a D4-454 running the program shown would be calculated as follows.

Program Control Instructions

Instruction	Time
STR X0	0.96 μ s
OR C0	0.9 μ s
ANDN X1	0.9 μ s
OUT Y0	2.9 μ s
STRN C100	1.0 μ s
LD K10	12.7 μ s
STRN C101	1.0 μ s
OUT V2002	4.7 μ s
STRN C102	1.0 μ s
LD K50	12.7 μ s
STRN C103	1.0 μ s
OUT V2006	4.7 μ s
STR X5	4.7 μ s
ANDN X10	0.9 μ s
OUT Y3	2.9 μ s
END	8.5 μ s
TOTAL	61.6 μs

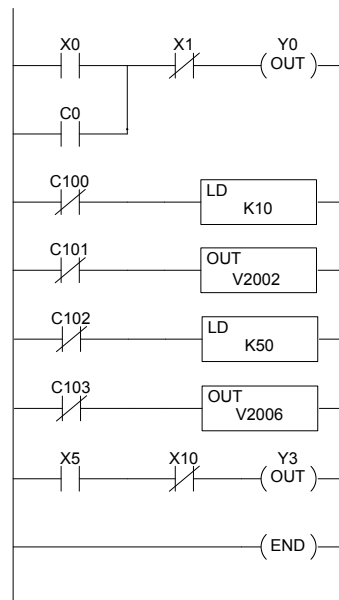

The D4-454 offers additional instructions that can change the way the program executes. These instructions include FOR/NEXT loops, Subroutines and Interrupt Routines. These instructions can interrupt the normal program flow and affect the program execution time. Chapter 5 provides detailed information on how these different types of instructions operate.

PLC Numbering Systems

If you are a new PLC user or are using AutomationDirect PLCs for the first time please take a moment to study how our PLCs use numbers. You'll find that each PLC manufacturer has their own conventions on the use of numbers in their PLCs. We want to take just a moment to familiarize you with how numbers are used in the DirectLOGIC PLCs. As any good computer does, PLCs store and manipulate numbers in binary form: just ones and zeros. So why do we have to deal with numbers in so many different forms? Numbers have meaning, and some representation are more convenient than others for particular purposes. Sometimes we use numbers to represent a size or amount of something. Other numbers refer to locations or addresses, or to time. In science we attach engineering units to numbers to give a particular meaning. (See the Number Systems Appendix for numbering system details.)

octal	49.832	binary
? 1482	BCD ?	? 0402 ?
3A9	7 -961428	ASCII
1001011011	hexadecimal	
decimal	177 ?	1011
-300124	A	72B ?

PLC Resources

PLCs offer a fixed amount of resources, depending on the model and configuration. We use the word "resources" to include variable memory (V-memory), I/O points, timers, counters, etc. Most modular PLCs allow you to add I/O points in groups of eight. In fact, all the resources of our DirectLOGIC are counted in octal. It's easier for computers to count in groups of eight than ten, because eight is an even power of 2.

Octal means simply counting in groups of eight things at a time. In the figure to the right, there are eight circles. The quantity in decimal is "8", but in octal it is "10" (8 and 9 are not valid in octal). In octal, "10" means 1 group of 8 plus 0 (no individuals).

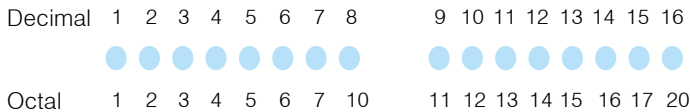
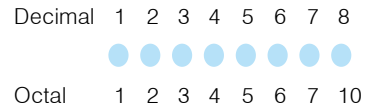

After counting PLC resources, it's time to access PLC resources (there's a difference). The CPU instruction set accesses resources of the PLC using octal addresses. Octal addresses are the same as octal quantities, except they start counting at zero. The number zero is significant to a computer, so we don't skip it.

Our circles are in an array of square containers to the right. To access a resource, our PLC instruction will address its location using the octal references shown. If these were counters, "CT14" would access the black circle location.

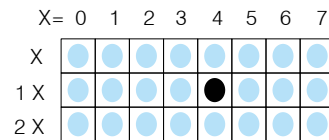

V-Memory

Variable memory (V-memory) stores data for the ladder program and for configuration settings. V-memory locations and V-memory addresses are the same thing, and are numbered in octal. For example, V2073 is a valid location, while V1983 is not valid (“9” and “8” are not valid octal digits).

Each V-memory location is one data word wide, meaning 16 bits. For configuration registers, our manuals will show each bit of a V-memory word. The least significant bit (LSB) will be on the right and the most significant bit (MSB) on the left. We use the word “significant”, referring to the relative binary weighting of the bits.

V-memory is 16-bit binary, but we rarely program the data registers one bit at a

time. We use instructions or viewing tools that let us work with binary, decimal, octal and hexadecimal numbers. All these are converted and stored as binary for us.

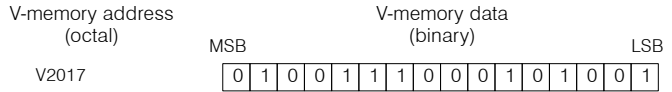

A frequently-asked question is “How do I tell if a number is binary, octal, BCD, or hex”? The answer is that we usually cannot tell just by looking at the data, but it does not really matter. What matters is: the source or mechanism which writes data into a V-memory location and the thing which later reads it must both use the same data type (i.e., octal, hex, binary, or whatever). The V-memory location is just a storage box, that’s all. It does not convert or move the data on its own.

Binary-Coded Decimal Numbers

Since humans naturally count in decimal (10 fingers, 10 toes), we prefer to enter and view PLC data in decimal as well (via operator interfaces). However, computers are more efficient in using pure binary numbers. A compromise solution between the two is Binary-Coded Decimal (BCD) representation. A BCD digit ranges from 0 to 9, and is stored as four binary bits (a nibble). This permits each V-memory location to store four BCD digits, with a range of decimal numbers from 0000 to 9999.

In a pure binary sense, a 16-bit word represents numbers from 0 to 65535. In storing BCD numbers, the range is reduced to 0 to 9999. Many math instructions use BCD data, and DirectSOFT allows us to enter and view data in BCD. Special RLL instructions convert from BCD to binary, or visa-versa.

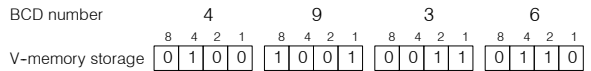

Hexadecimal Numbers

Hexadecimal numbers are similar to BCD numbers, except they utilize all possible binary values in each 4-bit digit. They are base-16 numbers so we need 16 different digits. To extend our decimal digits 0 through 9, we use A through F as shown.

A 4-digit hexadecimal number can represent all 65536 values in a V-memory word.

Decimal	0	1	2	3	4	5	6	7	8	9	10	11	12	13	14	15
Hexadecimal	0	1	2	3	4	5	6	7	8	9	A	B	C	D	E	F

The range is from 0000 to FFFF (hex). PLCs often need this full range for sensor data, etc. Hexadecimal is just a convenient way for humans to view full binary data.

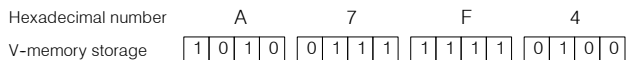

Memory Map

With any PLC system, you generally have many different types of information to process. This includes input device status, output device status, various timing elements, part counts, etc. It is important to understand how the system represents and stores the various types of data. For example, you need to know how the system identifies input points, output points, data words, etc. The following paragraphs discuss the various memory types used in the D4-454 CPUs. Memory maps follow the memory descriptions.

Octal Numbering Systems

All memory locations or areas are numbered in octal (base 8). The diagram shows how the octal numbering system works for the discrete input points. Notice the octal system does not contain any numbers with the digits 8 or 9.

Refer to the previous section on PLC Numbering Systems for more on octal numbering.

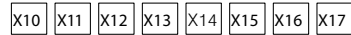
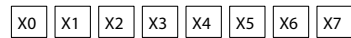
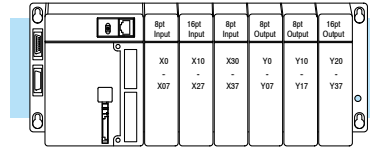

Discrete and Word Locations

As you examine the different memory types, you'll notice two types of memory in the DL405, discrete and word memory. Discrete memory is one bit that can be either a 1 or a 0. Word memory is referred to as V-memory (variable) and is a 16-bit location normally used to manipulate data/numbers, etc.

Some information is automatically stored in V-memory. For example, the timer current values are stored in V-memory.

Discrete – On or Off, 1 bit

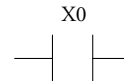

V-Memory Locations for Discrete Memory Areas

The discrete memory area is for inputs, outputs, control relays, special relays, stages, global relays, timer status bits and counter status bits. However, you can also access the bit data types as V-memory word. Each V-memory location contains 16 consecutive discrete locations. For example, the following diagram shows how the X inputs are mapped into V-memory locations.

Word Locations – 16 bits

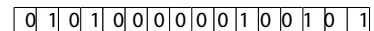

These discrete memory areas and the corresponding V-memory locations are listed in the Memory Map tables for the D4-454 in this chapter.

16 Discrete (X) Input Points

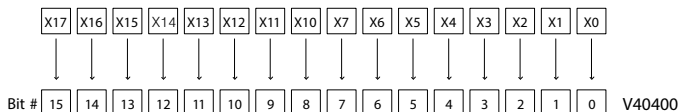

Input Points (X Data Type)

The discrete input points are noted by an X data type. Refer to the memory maps for the number of discrete input points for your CPU. In this example the output point Y0 will energize when input X0 turns on.



Output Points (Y Data Type)

The discrete output points are noted by a Y data type. Refer to the memory maps for the number of discrete input points for your CPU. In this example, output point Y1 will energize when input X1 turns on.



Control Relays (C Data Type)

Control relays are discrete bits normally used to control the user program. The control relays do not represent a real world device, that is, they cannot be physically tied to switches, output coils, etc. They are internal to the CPU. Because of this, control relays can be programmed as discrete inputs or discrete outputs. These locations are used in programming the discrete memory locations (C) or the corresponding word location which contains 16 consecutive discrete locations.

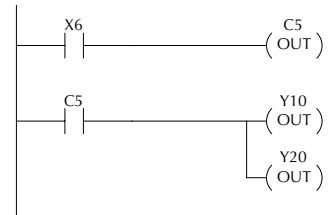

In this example, memory location C5 will energize when input X6 turns on. The second rung shows a simple example of how to use a control relay as an input.

Timers and Timer Status Bits (T Data Type)

Regardless of the number of timers, you have access to timer status bits that reflect the relationship between the current value and the preset value of a specified timer. The timer status bits will be on when the current value is equal or greater than the preset value of a corresponding timer.

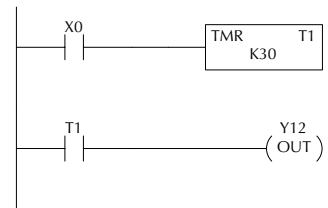

In this example, when input X0 turns on, timer T1 will start. When the timer reaches the preset of 3 seconds (K of 30) timer status contact T1 turns on. When T1 turns on, output Y12 turns on. Turning off X0 resets the timer.



NOTE: Some timers and counters use one V-memory register, and other types require two V-memory registers. See the instruction descriptions in Chapter 5.

Timer Current Values (V Data Type)

Some information is automatically stored in V-memory, such as the current values associated with timers. For example V0 holds the current value for Timer 0, V1 holds the current value for Timer 1, etc. These are 4-digit BCD values.

The primary reason for this is programming flexibility. The example shows you how you can use relational contacts to monitor several time intervals from a single timer.

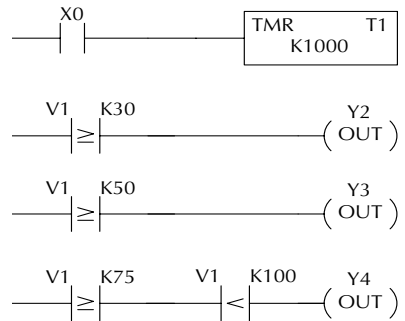

Counters and Counter Status Bits (CT Data type)

There are 128 counters available in the CPU. Counter status bits that reflect the relationship between the current value and the preset value of a specified counter. The counter status bit will be on when the current value is equal to or greater than the preset value of a corresponding counter.

Each time contact X0 transitions from off to on, the counter increments by one. (If X1 comes on, the counter is reset to zero.) When the counter reaches the preset of 10 counts (K of 10) counter status contact CT3 turns on. When CT3 turns on, output Y2 turns on.

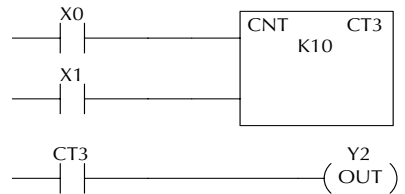

Counter Current Values (V Data Type)

Just like the timers, the counter current values are also automatically stored in V-memory. For example, V1000 holds the current value for Counter CT0, V1001 holds the current value for Counter CT1, etc. These can also be designated as CTA0 (Counter Accumulated) for Counter 0 and CTA01 for Counter 1.

The primary reason for this is programming flexibility. The example shows how you can use relational contacts to monitor the counter values.

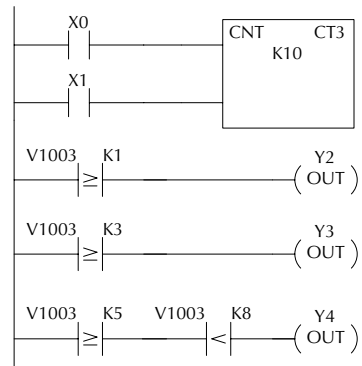

Word Memory (V Data Type)

Word memory is referred to as V-memory (variable) and is a 16-bit location normally used to manipulate data/numbers, store data/numbers, etc.

Some information is automatically stored in V-memory. For example, the timer current values are stored in V-memory.

The example shows how a four-digit BCD constant is loaded into the accumulator and then stored in a V-memory location.

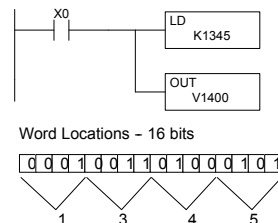

Stages (S Data type)

Stages are used in RLLPLUS programs to create a structured program, similar to a flowchart. Each program Stage denotes a program segment. When the program segment, or Stage, is active, the logic within that segment is executed. If the Stage is off, or inactive, the logic is not executed and the CPU skips to the next active Stage. (See Chapter 7 for a more detailed description of RLLPLUS programming.)

Each Stage also has a discrete status bit that can be used as an input to indicate whether the Stage is active or inactive. If the Stage is active, then the status bit is on. If the Stage is inactive, then the status bit is off. This status bit can also be turned on or off by other instructions, such as the SET or RESET instructions. This allows you to easily control stages throughout the program.

Special Relays (SP Data Type)

Special relays are discrete memory locations with pre-defined functionality. There are many different types of special relays. For example, some aid in program development, others provide system operating status information, etc. Please see the Special Relays Appendix for a complete listing of the special relays.

In this example, control relay C10 will energize for 50ms and de-energize for 50ms because SP5 is a pre-defined relay that will be on for 50ms and off for 50ms.

Remote I/O Points (GX and GY Data Type)

Remote I/O points are represented by global relays. They are generally used only to control remote I/O, but they can be used as normal control relays when remote I/O is not used in the system. There are setup routines that must be placed in your application program to designate which locations are inputs and which are outputs. (The DL405 Remote and Slice I/O modules manual provides the details.)

In this example, memory location GY0 turns on when local input X3 is not ON. On the second rung, local output Y12 will turn ON when GX10 turns on.

Ladder Representation

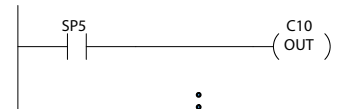
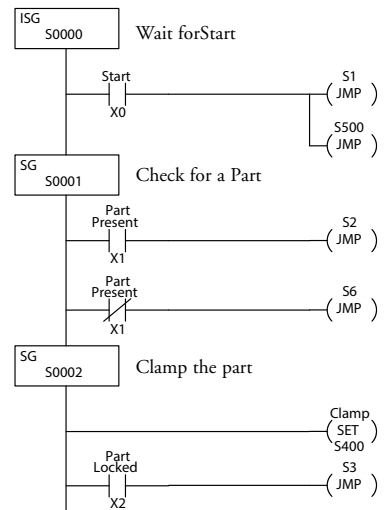

SP4: 1 second clock
 SP5: 100 ms clock
 SP6: 50 ms clock

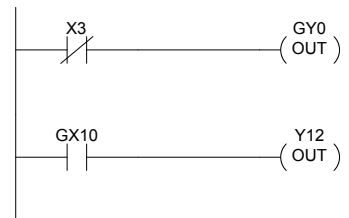

System Parameters (V Data Type)









Many system parameters, such as error codes, are automatically stored in pre-defined V-memory locations. These memory locations store clock / calendar information, error codes and other types of system setup information.

System V-Memory	Description of Contents
V737	Contains a BCD value (from 3 to 999) for Timed-interrupt 17 feature.
V7633	Bit 12 enables the low battery warning indicator.
V7747	Contains a 10 mS calendar timer used with the Clock / Calendar
V7766	Contains the number of seconds on the clock. (00 to 59)
V7767	Contains the number of minutes on the clock. (00 to 59)
V7770	Contains the number of hours on the clock. (00 to 23)
V7771	Contains the day of the week. (0=Sun., 1=Mon, etc.)
V7772	Contains the day of the month (1st, 2nd, etc.)
V7773	Contains the month. (01 to 12)
V7774	Contains the year. (00 to 99)

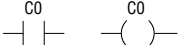
System V-Memory	Description of Contents
V736	Contains a BCD value (from 3 to 999) for Timed-interrupt 16 feature.
V7746	454: Battery voltage in tenths of a volt, (e.g., V7746 = 0031 is 3.1 Volts)

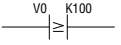
System V-Memory (continued)	Description of Contents
V7751	Fault Message Error Code — stores the 4-digit BCD code used with the FAULT instruction when the instruction is executed. If you've used ASCII messages, then the data label (DLBL)reference number for that message is stored here.
V7752	I/O configuration Error — stores the module ID code for the module that does not match the current configuration.
V7753	I/O Configuration Error — stores the correct module ID code.
V7754	I/O Configuration Error — identifies the base and slot number.
V7755	Error code — stores the fatal error code.
V7756	Error code — stores the major error code.
V7757	Communications Error Code — stores the minor error code.
V7760	Module Error — identifies the base and slot number.
V7762	Module Error — identifies the type of error.
V7763	Program Grammatical Error — identifies the location of a syntax error in a program.
V7764	Program Grammatical Error — identifies the type of error.
V7765	Scan — stores the total number of scan cycles that have occurred since the last Program Mode to Run Mode transition.
V7775	Scan — stores the current scan time.
V7776	Scan — stores the minimum scan time that has occurred since the last Program-to-Run Mode transition.
V7777	Scan — stores the maximum scan time that has occurred since the last Program-to-Run Mode transition.

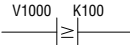
Systems CRs	Description of Contents
C740	Completion of setups: Ladder logic must turn this relay on when it has finished writing to the Remote I/O setup table.
C741	ON: The last state of inputs will be maintained OFF: The inputs will turn off when communication is lost
C743	Re-Start: Turning on this relay will resume after a communication hang-up on an error
C750 to C757	Setup Error: The corresponding relay will be ON if the setup table contains an error (C7250 = master, C751 =slave 1 C757 = slave 7)
C760 to C767	Communication Ready: The corresponding relay will be ON if the setup table data is valid (C760 = master, C761 = slave 1, C767 = slave 7)

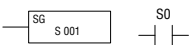
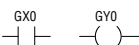
Memory Type	Discrete Memory Reference (octal)	Word Memory Reference (octal)	Qty. Decimal	Symbol
Input Points	X0 – X1777	V40400 – V40477	1024	
Output Points	Y0 – Y1777	V40500 – V40577	1024	
Control Relays	C0 – C3777	V40600 – V40777	2048	
Special Relays	SP0 – SP777	V41200 – V41237	512	
Timers	T0 – T377	V41100 – V41117	256	
Timer Current Values	None	V00000 – V00377	256	
Timer Status Bits	T0 – T377	V41100 – V41117	256	
Counters	CT0 – CT377	V41140 – V41157	256	
Counter Current Values	None	V01000 – V01377	256	
Counter Status Bits	CT0 – CT377	V41140 – V41157	256	
User Data Types	None	V1400 – V7377 V10000 – V36777	3072 11776	None specific, use with many instructions
Stages	S0 – S1777	V41000 – V41077	1024	
Remote In / Out	GX0 – GX3777 GY0 – GY3777	V40000 – V40177 V40200 – V40377	2048 2048	
System Parameters	None	V700 – V777 V7400 – V7777 V37000 – V37777	832	None specific, use with many instructions

DL405 Aliases

An alias is an alternate way of referring to certain memory types, such as timer / counter current values, V-memory locations for I/O points, etc., which simplifies understanding the memory address. The use of alias is optional, but some users may find the alias to be helpful when developing a program. The table below shows how the aliases can be used to reference memory locations.

Address Start	Alias Start	Example
V0	TA0	V0 is the timer accumulator value for timer 0, therefore, its alias is TA0. TA1 is the alias for V1, etc.
V1000	CTA0	V1000 is the counter accumulator value for counter 0, therefore, it's alias is CTA0. CTA1 is the alias for V1001, etc.
V40000	VGX	V40000 is the word memory reference for discrete bits GX0 through GX17, therefore, it's alias is VGX0. V40001 is the word memory reference for discrete bits GX20 through GX 37, therefore, its alias is VGX20.
V40200	VGX	V40200 is the word memory reference for discrete bits GY0 through GY17, therefore, it's alias is VGY0. V40201 is the word memory reference for discrete bits GY20 through GY 37, therefore, it's alias is VGY20.
V40400	VX0	V40400 is the word memory reference for discrete bits X0 through X17, therefore, it's alias is VX0. V40401 is the word memory reference for discrete bits X20 through X37, therefore, its alias is VX20.
V40500	VY0	V40500 is the word memory reference for discrete bits Y0 through Y17, therefore, it's alias is VY0. V40501 is the word memory reference for discrete bits Y20 through Y37, therefore, its alias is VY20.
V40600	VC0	V40600 is the word memory reference for discrete bits C0 through C17, therefore, it's alias is VC0. V40601 is the word memory reference for discrete bits C20 through C37, therefore, its alias is VC20.
V41000	VS0	V41000 is the word memory reference for discrete bits S0 through S17, therefore, it's alias is VS0. V41001 is the word memory reference for discrete bits S20 through S37, therefore, its alias is VS20.
V41100	VT0	V41100 is the word memory reference for discrete bits T0 through T17, therefore, it's alias is VT0. V41101 is the word memory reference for discrete bits T20 through T37, therefore, its alias is VT20.
V41140	VCT0	V41140 is the word memory reference for discrete bits CT0 through CT17, therefore, it's alias is VCT0. V41141 is the word memory reference for discrete bits CT20 through CT37, therefore, its alias is VCT20.
V41200	VSP0	V41200 is the word memory reference for discrete bits SP0 through SP17, therefore, it's alias is VSP0. V41201 is the word memory reference for discrete bits SP20 through SP37, therefore, its alias is VSP20.

X Input / Y Output Bit Map

This table provides a listing of individual Input and Output points as associated with each V-memory address bit in the D4-454 CPUs.

MSB															D4-454 Input (X) and Output (Y) Points															LSB	
15	14	13	12	11	10	9	8	7	6	5	4	3	2	1	0	X Input Address	Y Output Address														
017	016	015	014	013	012	011	010	007	006	005	004	003	002	001	000	V40400	V40500														
037	036	035	034	033	032	031	030	027	026	025	024	023	022	021	020	V40401	V40501														
057	056	055	054	053	052	051	050	047	046	045	044	043	042	041	040	V40402	V40502														
077	076	075	074	073	072	071	070	067	066	065	064	063	062	061	060	V40403	V40503														
117	116	115	114	113	112	111	110	107	106	105	104	103	102	101	100	V40404	V40504														
137	136	135	134	133	132	131	130	127	126	125	124	123	122	121	120	V40405	V40505														
157	156	155	154	153	152	151	150	147	146	145	144	143	142	141	140	V40406	V40506														
177	176	175	174	173	172	171	170	167	166	165	164	163	162	161	160	V40407	V40507														
217	216	215	214	213	212	211	210	207	206	205	204	203	202	201	200	V40410	V40510														
237	236	235	234	233	232	231	230	227	226	225	224	223	222	221	220	V40411	V40511														
257	256	255	254	253	252	251	250	247	246	245	244	243	242	241	240	V40412	V40512														
277	276	275	274	273	272	271	270	267	266	265	264	263	262	261	260	V40413	V40513														
317	316	315	314	313	312	311	310	307	306	305	304	303	302	301	300	V40414	V40514														
337	336	335	334	333	332	331	330	327	326	325	324	323	322	321	320	V40415	V40515														
357	356	355	354	353	352	351	350	347	346	345	344	343	342	341	340	V40416	V40516														
377	376	375	374	373	372	371	370	367	366	365	364	363	362	361	360	V40417	V40517														
417	416	415	414	413	412	411	410	407	406	405	404	403	402	401	400	V40420	V40520														
437	436	435	434	433	432	431	430	427	426	425	424	423	422	421	420	V40421	V40521														
457	456	455	454	453	452	451	450	447	446	445	444	443	442	441	440	V40422	V40522														
477	476	475	474	473	472	471	470	467	466	465	464	463	462	461	460	V40423	V40523														
517	516	515	514	513	512	511	510	507	506	505	504	503	502	501	500	V40424	V40524														
537	536	535	534	533	532	531	530	527	526	525	524	523	522	521	520	V40425	V40525														
557	556	555	554	553	552	551	550	547	546	545	544	543	542	541	540	V40426	V40526														
577	576	575	574	573	572	571	570	567	566	565	564	563	562	561	560	V40427	V40527														
617	616	615	614	613	612	611	610	607	606	605	604	603	602	601	600	V40430	V40530														
637	636	635	634	633	632	631	630	627	626	625	624	623	622	621	620	V40431	V40531														
657	656	655	654	653	652	651	650	647	646	645	644	643	642	641	640	V40432	V40532														
677	676	675	674	673	672	671	670	667	666	665	664	663	662	661	660	V40433	V40533														
717	716	715	714	713	712	711	710	707	706	705	704	703	702	701	700	V40434	V40534														
737	736	735	734	733	732	731	730	727	726	725	724	723	722	721	720	V40435	V40535														
757	756	755	754	753	752	751	750	747	746	745	744	743	742	741	740	V40436	V40536														
777	776	775	774	773	772	771	770	767	766	765	764	763	762	761	760	V40437	V40537														

Chapter 3: CPU Specifications and Operation

DL405 CPUs Additional Input (X) and Output (Y) Points (cont'd)																MSB	LSB		X Input Address	Y Output Address
15	14	13	12	11	10	9	8	7	6	5	4	3	2	1	0					
1017	1016	1015	1014	1013	1012	1011	1010	1007	1006	1005	1004	1003	1002	1001	1000	V40440	V40540			
1037	1036	1035	1034	1033	1032	1031	1030	1027	1026	1025	1024	1023	1022	1021	1020	V40441	V40541			
1057	1056	1055	1054	1053	1052	1051	1050	1047	1046	1045	1044	1043	1042	1041	1040	V40442	V40542			
1077	1076	1075	1074	1073	1072	1071	1070	1067	1066	1065	1064	1063	1062	1061	1060	V40443	V40543			
1117	1116	1115	1114	1113	1112	1111	1110	1107	1106	1105	1104	1103	1102	1101	1100	V40444	V40544			
1137	1136	1135	1134	1133	1132	1131	1130	1127	1126	1125	1124	1123	1122	1121	1120	V40445	V40545			
1157	1156	1155	1154	1153	1152	1151	1150	1147	1146	1145	1144	1143	1142	1141	1140	V40446	V40546			
1177	1176	1175	1174	1173	1172	1171	1170	1167	1166	1165	1164	1163	1162	1161	1160	V40447	V40547			
1217	1216	1215	1214	1213	1212	1211	1210	1207	1206	1205	1204	1203	1202	1201	1200	V40450	V40550			
1237	1236	1235	1234	1233	1232	1231	1230	1227	1226	1225	1224	1223	1222	1221	1220	V40451	V40551			
1257	1256	1255	1254	1253	1252	1251	1250	1247	1246	1245	1244	1243	1242	1241	1240	V40452	V40552			
1277	1276	1275	1274	1273	1272	1271	1270	1267	1266	1265	1264	1263	1262	1261	1260	V40453	V40553			
1317	1316	1315	1314	1313	1312	1311	1310	1307	1306	1305	1304	1303	1302	1301	1300	V40454	V40554			
1337	1336	1335	1334	1333	1332	1331	1330	1327	1326	1325	1324	1323	1322	1321	1320	V40455	V40555			
1357	1356	1355	1354	1353	1352	1351	1350	1347	1346	1345	1344	1343	1342	1341	1340	V40456	V40556			
1377	1376	1375	1374	1373	1372	1371	1370	1367	1366	1365	1364	1363	1362	1361	1360	V40457	V40557			
1417	1416	1415	1414	1413	1412	1411	1410	1407	1406	1405	1404	1403	1402	1401	1400	V40460	V40560			
1437	1436	1435	1434	1433	1432	1431	1430	1427	1426	1425	1424	1423	1422	1421	1420	V40461	V40561			
1457	1456	1455	1454	1453	1452	1451	1450	1447	1446	1445	1444	1443	1442	1441	1440	V40462	V40562			
1477	1476	1475	1474	1473	1472	1471	1470	1467	1466	1465	1464	1463	1462	1461	1460	V40463	V40563			
1517	1516	1515	1514	1513	1512	1511	1510	1507	1506	1505	1504	1503	1502	1501	1500	V40464	V40564			
1537	1536	1535	1534	1533	1532	1531	1530	1527	1526	1525	1524	1523	1522	1521	1520	V40465	V40565			
1557	1556	1555	1554	1553	1552	1551	1550	1547	1546	1545	1544	1543	1542	1541	1540	V40466	V40566			
1577	1576	1575	1574	1573	1572	1571	1570	1567	1566	1565	1564	1563	1562	1561	1560	V40467	V40567			
1617	1616	1615	1614	1613	1612	1611	1610	1607	1606	1605	1604	1603	1602	1601	1600	V40470	V40570			
1637	1636	1635	1634	1633	1632	1631	1630	1627	1626	1625	1624	1623	1622	1621	1620	V40471	V40571			
1657	1656	1655	1654	1653	1652	1651	1650	1647	1646	1645	1644	1643	1642	1641	1640	V40472	V40572			
1677	1676	1675	1674	1673	1672	1671	1670	1667	1666	1665	1664	1663	1662	1661	1660	V40473	V40573			
1717	1716	1715	1714	1713	1712	1711	1710	1707	1706	1705	1704	1703	1702	1701	1700	V40474	V40574			
1737	1736	1735	1734	1733	1732	1731	1730	1727	1726	1725	1724	1723	1722	1721	1720	V40475	V40575			
1757	1756	1755	1754	1753	1752	1751	1750	1747	1746	1745	1744	1743	1742	1741	1740	V40476	V40576			
1777	1776	1775	1774	1773	1772	1771	1770	1767	1766	1765	1764	1763	1762	1761	1760	V40477	V40577			

Control Relay Bit Map

This table provides a listing of the individual control relays associated with each V-memory address bit.

MSB																Control Relays (C)																LSB																Address
15	14	13	12	11	10	9	8	7	6	5	4	3	2	1	0	15	14	13	12	11	10	9	8	7	6	5	4	3	2	1	0	15	14	13	12	11	10	9	8	7	6	5	4	3	2	1	0	
017	016	015	014	013	012	011	010	007	006	005	004	003	002	001	000	V40600																																
037	036	035	034	033	032	031	030	027	026	025	024	023	022	021	020	V40601																																
057	056	055	054	053	052	051	050	047	046	045	044	043	042	041	040	V40602																																
077	076	075	074	073	072	071	070	067	066	065	064	063	062	061	060	V40603																																
117	116	115	114	113	112	111	110	107	106	105	104	103	102	101	100	V40604																																
137	136	135	134	133	132	131	130	127	126	125	124	123	122	121	120	V40605																																
157	156	155	154	153	152	151	150	147	146	145	144	143	142	141	140	V40606																																
177	176	175	174	173	172	171	170	167	166	165	164	163	162	161	160	V40607																																
217	216	215	214	213	212	211	210	207	206	205	204	203	202	201	200	V40610																																
237	236	235	234	233	232	231	230	227	226	225	224	223	222	221	220	V40611																																
257	256	255	254	253	252	251	250	247	246	245	244	243	242	241	240	V40612																																
277	276	275	274	273	272	271	270	267	266	265	264	263	262	261	260	V40613																																
317	316	315	314	313	312	311	310	307	306	305	304	303	302	301	300	V40614																																
337	336	335	334	333	332	331	330	327	326	325	324	323	322	321	320	V40615																																
357	356	355	354	353	352	351	350	347	346	345	344	343	342	341	340	V40616																																
377	376	375	374	373	372	371	370	367	366	365	364	363	362	361	360	V40617																																
417	416	415	414	413	412	411	410	407	406	405	404	403	402	401	400	V40620																																
437	436	435	434	433	432	431	430	427	426	425	424	423	422	421	420	V40621																																
457	456	455	454	453	452	451	450	447	446	445	444	443	442	441	440	V40622																																
477	476	475	474	473	472	471	470	467	466	465	464	463	462	461	460	V40623																																
517	516	515	514	513	512	511	510	507	506	505	504	503	502	501	500	V40624																																
537	536	535	534	533	532	531	530	527	526	525	524	523	522	521	520	V40625																																
557	556	555	554	553	552	551	550	547	546	545	544	543	542	541	540	V40626																																
577	576	575	574	573	572	571	570	567	566	565	564	563	562	561	560	V40627																																
617	616	615	614	613	612	611	610	607	606	605	604	603	602	601	600	V40630																																
637	636	635	634	633	632	631	630	627	626	625	624	623	622	621	620	V40631																																
657	656	655	654	653	652	651	650	647	646	645	644	643	642	641	640	V40632																																
677	676	675	674	673	672	671	670	667	666	665	664	663	662	661	660	V40633																																
717	716	715	714	713	712	711	710	707	706	705	704	703	702	701	700	V40634																																
737	736	735	734	733	732	731	730	727	726	725	724	723	722	721	720	V40635																																
757	756	755	754	753	752	751	750	747	746	745	744	743	742	741	740	V40636																																
777	736	775	774	773	772	771	770	767	766	765	764	763	762	761	760	V40637																																

Chapter 3: CPU Specifications and Operation

MSB															Additional Control Relays (C)															LSB			Address
15	14	13	12	11	10	9	8	7	6	5	4	3	2	1	0	15	14	13	12	11	10	9	8	7	6	5	4	3	2	1	0		
1017	1016	1015	1014	1013	1012	1011	1010	1007	1006	1005	1004	1003	1002	1001	1000	V40640																	
1037	1036	1035	1034	1033	1032	1031	1030	1027	1026	1025	1024	1023	1022	1021	1020	V40641																	
1057	1056	1055	1054	1053	1052	1051	1050	1047	1046	1045	1044	1043	1042	1041	1040	V40642																	
1077	1076	1075	1074	1073	1072	1071	1070	1067	1066	1065	1064	1063	1062	1061	1060	V40643																	
1117	1116	1115	1114	1113	1112	1111	1110	1107	1106	1105	1104	1103	1102	1101	1100	V40644																	
1137	1136	1135	1134	1133	1132	1131	1130	1127	1126	1125	1124	1123	1122	1121	1120	V40645																	
1157	1156	1155	1154	1153	1152	1151	1150	1147	1146	1145	1144	1143	1142	1141	1140	V40646																	
1177	1176	1175	1174	1173	1172	1171	1170	1167	1166	1165	1164	1163	1162	1161	1160	V40647																	
1217	1216	1215	1214	1213	1212	1211	1210	1207	1206	1205	1204	1203	1202	1201	1200	V40650																	
1237	1236	1235	1234	1233	1232	1231	1230	1227	1226	1225	1224	1223	1222	1221	1220	V40651																	
1257	1256	1255	1254	1253	1252	1251	1250	1247	1246	1245	1244	1243	1242	1241	1240	V40652																	
1277	1276	1275	1274	1273	1272	1271	1270	1267	1266	1265	1264	1263	1262	1261	1260	V40653																	
1317	1316	1315	1314	1313	1312	1311	1310	1307	1306	1305	1304	1303	1302	1301	1300	V40654																	
1337	1336	1335	1334	1333	1332	1331	1330	1327	1326	1325	1324	1323	1322	1321	1320	V40655																	
1357	1356	1355	1354	1353	1352	1351	1350	1347	1346	1345	1344	1343	1342	1341	1340	V40656																	
1377	1376	1375	1374	1373	1372	1371	1370	1367	1366	1365	1364	1363	1362	1361	1360	V40657																	
1417	1416	1415	1414	1413	1412	1411	1410	1407	1406	1405	1404	1403	1402	1401	1400	V40660																	
1437	1436	1435	1434	1433	1432	1431	1430	1427	1426	1425	1424	1423	1422	1421	1420	V40661																	
1457	1456	1455	1454	1453	1452	1451	1450	1447	1446	1445	1444	1443	1442	1441	1440	V40662																	
1477	1476	1475	1474	1473	1472	1471	1470	1467	1466	1465	1464	1463	1462	1461	1460	V40663																	
1517	1516	1515	1514	1513	1512	1511	1510	1507	1506	1505	1504	1503	1502	1501	1500	V40664																	
1537	1536	1535	1534	1533	1532	1531	1530	1527	1526	1525	1524	1523	1522	1521	1520	V40665																	
1557	1556	1555	1554	1553	1552	1551	1550	1547	1546	1545	1544	1543	1542	1541	1540	V40666																	
1577	1576	1575	1574	1573	1572	1571	1570	1567	1566	1565	1564	1563	1562	1561	1560	V40667																	
1617	1616	1615	1614	1613	1612	1611	1610	1607	1606	1605	1604	1603	1602	1601	1600	V40670																	
1637	1636	1635	1634	1633	1632	1631	1630	1627	1626	1625	1624	1623	1622	1621	1620	V40671																	
1657	1656	1655	1654	1653	1652	1651	1650	1647	1646	1645	1644	1643	1642	1641	1640	V40672																	
1677	1676	1675	1674	1673	1672	1671	1670	1667	1666	1665	1664	1663	1662	1661	1660	V40673																	
1717	1716	1715	1714	1713	1712	1711	1710	1707	1706	1705	1704	1703	1702	1701	1700	V40674																	
1737	1736	1735	1734	1733	1732	1731	1730	1727	1726	1725	1724	1723	1722	1721	1720	V40675																	
1757	1756	1755	1754	1753	1752	1751	1750	1747	1746	1745	1744	1743	1742	1741	1740	V40676																	
1777	1776	1775	1774	1773	1772	1771	1770	1767	1766	1765	1764	1763	1762	1761	1760	V40677																	

Chapter 3: CPU Specifications and Operation

MSB															Additional Control Relays (C)															LSB	Address
15	14	13	12	11	10	9	8	7	6	5	4	3	2	1	0	15	14	13	12	11	10	9	8	7	6	5	4	3	2	1	
2017	2016	2015	2014	2013	2012	2011	2010	2007	2006	2005	2004	2003	2002	2001	2000	V40700															
2037	2036	2035	2034	2033	2032	2031	2030	2027	2026	2025	2024	2023	2022	2021	2020	V40701															
2057	2056	2055	2054	2053	2052	2051	2050	2047	2046	2045	2044	2043	2042	2041	2040	V40702															
2077	2076	2075	2074	2073	2072	2071	2070	2067	2066	2065	2064	2063	2062	2061	2060	V40703															
2117	2116	2115	2114	2113	2112	2111	2110	2107	2106	2105	2104	2103	2102	2101	2100	V40704															
2137	2136	2135	2134	2133	2132	2131	2130	2127	2126	2125	2124	2123	2122	2121	2120	V40705															
2157	2156	2155	2154	2153	2152	2151	2150	2147	2146	2145	2144	2143	2142	2141	2140	V40706															
2177	2176	2175	2174	2173	2172	2171	2170	2167	2166	2165	2164	2163	2162	2161	2160	V40707															
2217	2216	2215	2214	2213	2212	2211	2210	2207	2206	2205	2204	2203	2202	2201	2200	V40710															
2237	2236	2235	2234	2233	2232	2231	2230	2227	2226	2225	2224	2223	2222	2221	2220	V40711															
2257	2256	2255	2254	2253	2252	2251	2250	2247	2246	2245	2244	2243	2242	2241	2240	V40712															
2277	2276	2275	2274	2273	2272	2271	2270	2267	2266	2265	2264	2263	2262	2261	2260	V40713															
2317	2316	2315	2314	2313	2312	2311	2310	2307	2306	2305	2304	2303	2302	2301	2300	V40714															
2337	2336	2335	2334	2333	2332	2331	2330	2327	2326	2325	2324	2323	2322	2321	2320	V40715															
2357	2356	2355	2354	2353	2352	2351	2350	2347	2346	2345	2344	2343	2342	2341	2340	V40716															
2377	2376	2375	2374	2373	2372	2371	2370	2367	2366	2365	2364	2363	2362	2361	2360	V40717															
2417	2416	2415	2414	2413	2412	2411	2410	2407	2406	2405	2404	2403	2402	2401	2400	V40720															
2437	2436	2435	2434	2433	2432	2431	2430	2427	2426	2425	2424	2423	2422	2421	2420	V40721															
2457	2456	2455	2454	2453	2452	2451	2450	2447	2446	2445	2444	2443	2442	2441	2440	V40722															
2477	2476	2475	2474	2473	2472	2471	2470	2467	2466	2465	2464	2463	2462	2461	2460	V40723															
2517	2516	2515	2514	2513	2512	2511	2510	2507	2506	2505	2504	2503	2502	2501	2500	V40724															
2537	2536	2535	2534	2533	2532	2531	2530	2527	2526	2525	2524	2523	2522	2521	2520	V40725															
2557	2556	2555	2554	2553	2552	2551	2550	2547	2546	2545	2544	2543	2542	2541	2540	V40726															
2577	2576	2575	2574	2573	2572	2571	2570	2567	2566	2565	2564	2563	2562	2561	2560	V40727															
2617	2616	2615	2614	2613	2612	2611	2610	2607	2606	2605	2604	2603	2602	2601	2600	V40730															
2637	2636	2635	2634	2633	2632	2631	2630	2627	2626	2625	2624	2623	2622	2621	2620	V40731															
2657	2656	2655	2654	2653	2652	2651	2650	2647	2646	2645	2644	2643	2642	2641	2640	V40732															
2677	2676	2675	2674	2673	2672	2671	2670	2667	2666	2665	2664	2663	2662	2661	2660	V40733															
2717	2716	2715	2714	2713	2712	2711	2710	2707	2706	2705	2704	2703	2702	2701	2700	V40734															
2737	2736	2735	2734	2733	2732	2731	2730	2727	2726	2725	2724	2723	2722	2721	2720	V40735															
2757	2756	2755	2754	2753	2752	2751	2750	2747	2746	2745	2744	2743	2742	2741	2740	V40736															
2777	2776	2775	2774	2773	2772	2771	2770	2767	2766	2765	2764	2763	2762	2761	2760	V40737															

Chapter 3: CPU Specifications and Operation

MSB		Additional Control Relays (C) (cont'd)														LSB		Address
15	14	13	12	11	10	9	8	7	6	5	4	3	2	1	0			
3017	3016	3015	3014	3013	3012	3011	3010	3007	3006	3005	3004	3003	3002	3001	3000	V40740		
3037	3036	3035	3034	3033	3032	3031	3030	3027	3026	3025	3024	3023	3022	3021	3020	V40741		
3057	3056	3055	3054	3053	3052	3051	3050	3047	3046	3045	3044	3043	3042	3041	3040	V40742		
3077	3076	3075	3074	3073	3072	3071	3070	3067	3066	3065	3064	3063	3062	3061	3060	V40743		
3117	3116	3115	3114	3113	3112	3111	3110	3107	3106	3105	3104	3103	3102	3101	3100	V40744		
3137	3136	3135	3134	3133	3132	3131	3130	3127	3126	3125	3124	3123	3122	3121	3120	V40745		
3157	3156	3155	3154	3153	3152	3151	3150	3147	3146	3145	3144	3143	3142	3141	3140	V40746		
3177	3176	3175	3174	3173	3172	3171	3170	3167	3166	3165	3164	3163	3162	3161	3160	V40747		
3217	3216	3215	3214	3213	3212	3211	3210	3207	3206	3205	3204	3203	3202	3201	3200	V40750		
3237	3236	3235	3234	3233	3232	3231	3230	3227	3226	3225	3224	3223	3222	3221	3220	V40751		
3257	3256	3255	3254	3253	3252	3251	3250	3247	3246	3245	3244	3243	3242	3241	3240	V40752		
3277	3276	3275	3274	3273	3272	3271	3270	3267	3266	3265	3264	3263	3262	3261	3260	V40753		
3317	3316	3315	3314	3313	3312	3311	3310	3307	3306	3305	3304	3303	3302	3301	3300	V40754		
3337	3336	3335	3334	3333	3332	3331	3330	3327	3326	3325	3324	3323	3322	3321	3320	V40755		
3357	3356	3355	3354	3353	3352	3351	3350	3347	3346	3345	3344	3343	3342	3341	3340	V40756		
3377	3376	3375	3374	3373	3372	3371	3370	3367	3366	3365	3364	3363	3362	3361	3360	V40757		
3417	3416	3415	3414	3413	3412	3411	3410	3407	3406	3405	3404	3403	3402	3401	3400	V40760		
3437	3436	3435	3434	3433	3432	3431	3430	3427	3426	3425	3424	3423	3422	3421	3420	V40761		
3457	3456	3455	3454	3453	3452	3451	3450	3447	3446	3445	3444	3443	3442	3441	3440	V40762		
3477	3476	3475	3474	3473	3472	3471	3470	3467	3466	3465	3464	3463	3462	3461	3460	V40763		
3517	3516	3515	3514	3513	3512	3511	3510	3507	3506	3505	3504	3503	3502	3501	3500	V40764		
3537	3536	3535	3534	3533	3532	3531	3530	3527	3526	3525	3524	3523	3522	3521	3520	V40765		
3557	3556	3555	3554	3553	3552	3551	3550	3547	3546	3545	3544	3543	3542	3541	3540	V40766		
3577	3576	3575	3574	3573	3572	3571	3570	3567	3566	3565	3564	3563	3562	3561	3560	V40767		
3617	3616	3615	3614	3613	3612	3611	3610	3607	3606	3605	3604	3603	3602	3601	3600	V40770		
3637	3636	3635	3634	3633	3632	3631	3630	3627	3626	3625	3624	3623	3622	3621	3620	V40771		
3657	3656	3655	3654	3653	3652	3651	3650	3647	3646	3645	3644	3643	3642	3641	3640	V40772		
3677	3676	3675	3674	3673	3672	3671	3670	3667	3666	3665	3664	3663	3662	3661	3660	V40773		
3717	3716	3715	3714	3713	3712	3711	3710	3707	3706	3705	3704	3703	3702	3701	3700	V40774		
3737	3736	3735	3734	3733	3732	3731	3730	3727	3726	3725	3724	3723	3722	3721	3720	V40775		
3757	3756	3755	3754	3753	3752	3751	3750	3747	3746	3745	3744	3743	3742	3741	3740	V40776		
3777	3776	3775	3774	3773	3772	3771	3770	3767	3766	3765	3764	3763	3762	3761	3760	V40777		

Timer and Counter Status Bit Map

This table provides a listing of individual timer and counter contacts associated with each V-memory address bit.

Timer (T) and Counter (CT) Contacts															LSB			
MSB	15	14	13	12	11	10	9	8	7	6	5	4	3	2	1	0	Timer Address	Counter Address
017	016	015	014	013	012	011	010	007	006	005	004	003	002	001	000		V41100	V41140
037	036	035	034	033	032	031	030	027	026	025	024	023	022	021	020		V41101	V41141
057	056	055	054	053	052	051	050	047	046	045	044	043	042	041	040		V41102	V41142
077	076	075	074	073	072	071	070	067	066	065	064	063	062	061	060		V41103	V41143
117	116	115	114	113	112	111	110	107	106	105	104	103	102	101	100		V41104	V41144
137	136	135	134	133	132	131	130	127	126	125	124	123	122	121	120		V41105	V41145
157	156	155	154	153	152	151	150	147	146	145	144	143	142	141	140		V41106	V41146
177	176	175	174	173	172	171	170	167	166	165	164	163	162	161	160		V41107	V41147

This portion of the table shows additional Timer contacts available with the D4-454.

Additional Timer (T) Contacts															LSB		
MSB	15	14	13	12	11	10	9	8	7	6	5	4	3	2	1	0	Timer Address
217	216	215	214	213	212	211	210	207	206	205	204	203	202	201	200		V41110
237	236	235	234	233	232	231	230	227	226	225	224	223	222	221	220		V41111
257	256	255	254	253	252	251	250	247	246	245	244	243	242	241	240		V41112
277	276	275	274	273	272	271	270	267	266	265	264	263	262	261	260		V41113
317	316	315	314	313	312	311	310	307	306	305	304	303	302	301	300		V41114
337	336	335	334	333	332	331	330	327	326	325	324	323	322	321	320		V41115
357	356	355	354	353	352	351	350	347	346	345	344	343	342	341	340		V41116
377	376	375	374	373	372	371	370	367	366	365	364	363	362	361	360		V41117

This portion of the table shows additional Counter contacts available with the D4-454.

Additional Counter (CT) Contacts															LSB		
MSB	15	14	13	12	11	10	9	8	7	6	5	4	3	2	1	0	Counter Address
217	216	215	214	213	212	211	210	207	206	205	204	203	202	201	200		V41150
237	236	235	234	233	232	231	230	227	226	225	224	223	222	221	220		V41151
257	256	255	254	253	252	251	250	247	246	245	244	243	242	241	240		V41152
277	276	275	274	273	272	271	270	267	266	265	264	263	262	261	260		V41153
317	316	315	314	313	312	311	310	307	306	305	304	303	302	301	300		V41154
337	336	335	334	333	332	331	330	327	326	325	324	323	322	321	320		V41155
357	356	355	354	353	352	351	350	347	346	345	344	343	342	341	340		V41156
377	376	375	374	373	372	371	370	367	366	365	364	363	362	361	360		V41157

Remote I/O Bit Map

This table provides a listing of individual remote I/O points associated with each V-memory address bit. The D4-454 uses the GX addresses for remote input point references and the GY addresses for remote output point references.

Remote I/O (GX) and (GY) Point															GX Address	GY Address	
MSB	Remote I/O (GX) and (GY) Point																LSB
15	14	13	12	11	10	9	8	7	6	5	4	3	2	1	0		
017	016	015	014	013	012	011	010	007	006	005	004	003	002	001	000	V40000	V40200
037	036	035	034	033	032	031	030	027	026	025	024	023	022	021	020	V40001	V40201
057	056	055	054	053	052	051	050	047	046	045	044	043	042	041	040	V40002	V40202
077	076	075	074	073	072	071	070	067	066	065	064	063	062	061	060	V40003	V40203
117	116	115	114	113	112	111	110	107	106	105	104	103	102	101	100	V40004	V40204
137	136	135	134	133	132	131	130	127	126	125	124	123	122	121	120	V40005	V40205
157	156	155	154	153	152	151	150	147	146	145	144	143	142	141	140	V40006	V40206
177	176	175	174	173	172	171	170	167	166	165	164	163	162	161	160	V40007	V40207
217	216	215	214	213	212	211	210	207	206	205	204	203	202	201	200	V40010	V40210
237	236	235	234	233	232	231	230	227	226	225	224	223	222	221	220	V40011	V40211
257	256	255	254	253	252	251	250	247	246	245	244	243	242	241	240	V40012	V40212
277	276	275	274	273	272	271	270	267	266	265	264	263	262	261	260	V40013	V40213
317	316	315	314	313	312	311	310	307	306	305	304	303	302	301	300	V40014	V40214
337	336	335	334	333	332	331	330	327	326	325	324	323	322	321	320	V40015	V40215
357	356	355	354	353	352	351	350	347	346	345	344	343	342	341	340	V40016	V40216
377	376	375	374	373	372	371	370	367	366	365	364	363	362	361	360	V40017	V40217
417	416	415	414	413	412	411	410	407	406	405	404	403	402	401	400	V40020	V40220
437	436	435	434	433	432	431	430	427	426	425	424	423	422	421	420	V40021	V40221
457	456	455	454	453	452	451	450	447	446	445	444	443	442	441	440	V40022	V40222
477	476	475	474	473	472	471	470	467	466	465	464	463	462	461	460	V40023	V40223
517	516	515	514	513	512	511	510	507	506	505	504	503	502	501	500	V40024	V40224
537	536	535	534	533	532	531	530	527	526	525	524	523	522	521	520	V40025	V40225
557	556	555	554	553	552	551	550	547	546	545	544	543	542	541	540	V40026	V40226
577	576	575	574	573	572	571	570	567	566	565	564	563	562	561	560	V40027	V40227
617	616	615	614	613	612	611	610	607	606	605	604	603	602	601	600	V40030	V40230
637	636	635	634	633	632	631	630	627	626	625	624	623	622	621	620	V40031	V40231
657	656	655	654	653	652	651	650	647	646	645	644	643	642	641	640	V40032	V40232
677	676	675	674	673	672	671	670	667	666	665	664	663	662	661	660	V40033	V40233
717	716	715	714	713	712	711	710	707	706	705	704	703	702	701	700	V40034	V40234
737	736	735	734	733	732	731	730	727	726	725	724	723	722	721	720	V40035	V40235
757	756	755	754	753	752	751	750	747	746	745	744	743	742	741	740	V40036	V40236
777	776	775	774	773	772	771	770	767	766	765	764	763	762	761	760	V40037	V40237

Chapter 3: CPU Specifications and Operation

This portion of the table shows additional Remote I/O (GX) points and (GY) remote output available with the D4-454.

MSB																Additional Remote I/O (GX) Points		LSB		GX Address	GY Address
15	14	13	12	11	10	9	8	7	6	5	4	3	2	1	0						
1017	1016	1015	1014	1013	1012	1011	1010	1007	1006	1005	1004	1003	1002	1001	1000	V40040	V40240				
1037	1036	1035	1034	1033	1032	1031	1030	1027	1026	1025	1024	1023	1022	1021	1020	V40041	V40241				
1057	1056	1055	1054	1053	1052	1051	1050	1047	1046	1045	1044	1043	1042	1041	1040	V40042	V40242				
1077	1076	1075	1074	1073	1072	1071	1070	1067	1066	1065	1064	1063	1062	1061	1060	V40043	V40243				
1117	1116	1115	1114	1113	1112	1111	1110	1107	1106	1105	1104	1103	1102	1101	1100	V40044	V40244				
1137	1136	1135	1134	1133	1132	1131	1130	1127	1126	1125	1124	1123	1122	1121	1120	V40045	V40245				
1157	1156	1155	1154	1153	1152	1151	1150	1147	1146	1145	1144	1143	1142	1141	1140	V40046	V40246				
1177	1176	1175	1174	1173	1172	1171	1170	1167	1166	1165	1164	1163	1162	1161	1160	V40047	V40247				
1217	1216	1215	1214	1213	1212	1211	1210	1207	1206	1205	1204	1203	1202	1201	1200	V40050	V40250				
1237	1236	1235	1234	1233	1232	1231	1230	1227	1226	1225	1224	1223	1222	1221	1220	V40051	V40251				
1257	1256	1255	1254	1253	1252	1251	1250	1247	1246	1245	1244	1243	1242	1241	1240	V40052	V40252				
1277	1276	1275	1274	1273	1272	1271	1270	1267	1266	1265	1264	1263	1262	1261	1260	V40053	V40253				
1317	1316	1315	1314	1313	1312	1311	1310	1307	1306	1305	1304	1303	1302	1301	1300	V40054	V40254				
1337	1336	1335	1334	1333	1332	1331	1330	1327	1326	1325	1324	1323	1322	1321	1320	V40055	V40255				
1357	1356	1355	1354	1353	1352	1351	1350	1347	1346	1345	1344	1343	1342	1341	1340	V40056	V40256				
1377	1376	1375	1374	1373	1372	1371	1370	1367	1366	1365	1364	1363	1362	1361	1360	V40057	V40257				
1417	1416	1415	1414	1413	1412	1411	1410	1407	1406	1405	1404	1403	1402	1401	1400	V40060	V40260				
1437	1436	1435	1434	1433	1432	1431	1430	1427	1426	1425	1424	1423	1422	1421	1420	V40061	V40261				
1457	1456	1455	1454	1453	1452	1451	1450	1447	1446	1445	1444	1443	1442	1441	1440	V40062	V40262				
1477	1476	1475	1474	1473	1472	1471	1470	1467	1466	1465	1464	1463	1462	1461	1460	V40063	V40263				
1517	1516	1515	1514	1513	1512	1511	1510	1507	1506	1505	1504	1503	1502	1501	1500	V40064	V40264				
1537	1536	1535	1534	1533	1532	1531	1530	1527	1526	1525	1524	1523	1522	1521	1520	V40065	V40265				
1557	1556	1555	1554	1553	1552	1551	1550	1547	1546	1545	1544	1543	1542	1541	1540	V40066	V40266				
1577	1576	1575	1574	1573	1572	1571	1570	1567	1566	1565	1564	1563	1562	1561	1560	V40067	V40267				
1617	1616	1615	1614	1613	1612	1611	1610	1607	1606	1605	1604	1603	1602	1601	1600	V40070	V40270				
1637	1636	1635	1634	1633	1632	1631	1630	1627	1626	1625	1624	1623	1622	1621	1620	V40071	V40271				
1657	1656	1655	1654	1653	1652	1651	1650	1647	1646	1645	1644	1643	1642	1641	1640	V40072	V40272				
1677	1676	1675	1674	1673	1672	1671	1670	1667	1666	1665	1664	1663	1662	1661	1660	V40073	V40273				
1717	1716	1715	1714	1713	1712	1711	1710	1707	1706	1705	1704	1703	1702	1701	1700	V40074	V40274				
1737	1736	1735	1734	1733	1732	1731	1730	1727	1726	1725	1724	1723	1722	1721	1720	V40075	V40275				
1757	1756	1755	1754	1753	1752	1751	1750	1747	1746	1745	1744	1743	1742	1741	1740	V40076	V40276				
1777	1776	1775	1774	1773	1772	1771	1770	1767	1766	1765	1764	1763	1762	1761	1760	V40077	V40277				

Chapter 3: CPU Specifications and Operation

MSB																Additional Remote I/O (GX) and (GY) Points		LSB		GX Address	GY Address
15	14	13	12	11	10	9	8	7	6	5	4	3	2	1	0						
2017	2016	2015	2014	2013	2012	2011	2010	2007	2006	2005	2004	2003	2002	2001	2000	V40100	V40300				
2037	2036	2035	2034	2033	2032	2031	2030	2027	2026	2025	2024	2023	2022	2021	2020	V40101	V40301				
2057	2056	2055	2054	2053	2052	2051	2050	2047	2046	2045	2044	2043	2042	2041	2040	V40102	V40302				
2077	2076	2075	2074	2073	2072	2071	2070	2067	2066	2065	2064	2063	2062	2061	2060	V40103	V40303				
2117	2116	2115	2114	2113	2112	2111	2110	2107	2106	2105	2104	2103	2102	2101	2100	V40104	V40304				
2137	2136	2135	2134	2133	2132	2131	2130	2127	2126	2125	2124	2123	2122	2121	2120	V40105	V40305				
2157	2156	2155	2154	2153	2152	2151	2150	2147	2146	2145	2144	2143	2142	2141	2140	V40106	V40306				
2177	2176	2175	2174	2173	2172	2171	2170	2167	2166	2165	2164	2163	2162	2161	2160	V40107	V40307				
2217	2216	2215	2214	2213	2212	2211	2210	2207	2206	2205	2204	2203	2202	2201	2200	V40110	V40310				
2237	2236	2235	2234	2233	2232	2231	2230	2227	2226	2225	2224	2223	2222	2221	2220	V40111	V40311				
2257	2256	2255	2254	2253	2252	2251	2250	2247	2246	2245	2244	2243	2242	2241	2240	V40112	V40312				
2277	2276	2275	2274	2273	2272	2271	2270	2267	2266	2265	2264	2263	2262	2261	2260	V40113	V40313				
2317	2316	2315	2314	2313	2312	2311	2310	2307	2306	2305	2304	2303	2302	2301	2300	V40114	V40314				
2337	2336	2335	2334	2333	2332	2331	2330	2327	2326	2325	2324	2323	2322	2321	2320	V40115	V40315				
2357	2356	2355	2354	2353	2352	2351	2350	2347	2346	2345	2344	2343	2342	2341	2340	V40116	V40316				
2377	2376	2375	2374	2373	2372	2371	2370	2367	2366	2365	2364	2363	2362	2361	2360	V40117	V40317				
2417	2416	2415	2414	2413	2412	2411	2410	2407	2406	2405	2404	2403	2402	2401	2400	V40120	V40320				
2437	2436	2435	2434	2433	2432	2431	2430	2427	2426	2425	2424	2423	2422	2421	2420	V40121	V40321				
2457	2456	2455	2454	2453	2452	2451	2450	2447	2446	2445	2444	2443	2442	2441	2440	V40122	V40322				
2477	2476	2475	2474	2473	2472	2471	2470	2467	2466	2465	2464	2463	2462	2461	2460	V40123	V40323				
2517	2516	2515	2514	2513	2512	2511	2510	2507	2506	2505	2504	2503	2502	2501	2500	V40124	V40324				
2537	2536	2535	2534	2533	2532	2531	2530	2527	2526	2525	2524	2523	2522	2521	2520	V40125	V40325				
2557	2556	2555	2554	2553	2552	2551	2550	2547	2546	2545	2544	2543	2542	2541	2540	V40126	V40326				
2577	2576	2575	2574	2573	2572	2571	2570	2567	2566	2565	2564	2563	2562	2561	2560	V40127	V40327				
2617	2616	2615	2614	2613	2612	2611	2610	2607	2606	2605	2604	2603	2602	2601	2600	V40130	V40330				
2637	2636	2635	2634	2633	2632	2631	2630	2627	2626	2625	2624	2623	2622	2621	2620	V40131	V40331				
2657	2656	2655	2654	2653	2652	2651	2650	2647	2646	2645	2644	2643	2642	2641	2640	V40132	V40332				
2677	2676	2675	2674	2673	2672	2671	2670	2667	2666	2665	2664	2663	2662	2661	2660	V40133	V40333				
2717	2716	2715	2714	2713	2712	2711	2710	2707	2706	2705	2704	2703	2702	2701	2700	V40134	V40334				
2737	2736	2735	2734	2733	2732	2731	2730	2727	2726	2725	2724	2723	2722	2721	2720	V40135	V40335				
2757	2756	2755	2754	2753	2752	2751	2750	2747	2746	2745	2744	2743	2742	2741	2740	V40136	V40336				
2777	2776	2775	2774	2773	2772	2771	2770	2767	2766	2765	2764	2763	2762	2761	2760	V40137	V40337				

Chapter 3: CPU Specifications and Operation

MSB															Additional Remote I/O (GX) and (GY) Points															LSB	G X Address	G Y Address
15	14	13	12	11	10	9	8	7	6	5	4	3	2	1	0	15	14	13	12	11	10	9	8	7	6	5	4	3	2	1		
3017	3016	3015	3014	3013	3012	3011	3010	3007	3006	3005	3004	3003	3002	3001	3000	V40140	V40340															
3037	3036	3035	3034	3033	3032	3031	3030	3027	3026	3025	3024	3023	3022	3021	3020	V40141	V40341															
3057	3056	3055	3054	3053	3052	3051	3050	3047	3046	3045	3044	3043	3042	3041	3040	V40142	V40342															
3077	3076	3075	3074	3073	3072	3071	3070	3067	3066	3065	3064	3063	3062	3061	3060	V40143	V40343															
3117	3116	3115	3114	3113	3112	3111	3110	3107	3106	3105	3104	3103	3102	3101	3100	V40144	V40344															
3137	3136	3135	3134	3133	3132	3131	3130	3127	3126	3125	3124	3123	3122	3121	3120	V40145	V40345															
3157	3156	3155	3154	3153	3152	3151	3150	3147	3146	3145	3144	3143	3142	3141	3140	V40146	V40346															
3177	3176	3175	3174	3173	3172	3171	3170	3167	3166	3165	3164	3163	3162	3161	3160	V40147	V40347															
3217	3216	3215	3214	3213	3212	3211	3210	3207	3206	3205	3204	3203	3202	3201	3200	V40150	V40350															
3237	3236	3235	3234	3233	3232	3231	3230	3227	3226	3225	3224	3223	3222	3221	3220	V40151	V40351															
3257	3256	3255	3254	3253	3252	3251	3250	3247	3246	3245	3244	3243	3242	3241	3240	V40152	V40352															
3277	3276	3275	3274	3273	3272	3271	3270	3267	3266	3265	3264	3263	3262	3261	3260	V40153	V40353															
3317	3316	3315	3314	3313	3312	3311	3310	3307	3306	3305	3304	3303	3302	3301	3300	V40154	V40354															
3337	3336	3335	3334	3333	3332	3331	3330	3327	3326	3325	3324	3323	3322	3321	3320	V40155	V40355															
3357	3356	3355	3354	3353	3352	3351	3350	3347	3346	3345	3344	3343	3342	3341	3340	V40156	V40356															
3377	3376	3375	3374	3373	3372	3371	3370	3367	3366	3365	3364	3363	3362	3361	3360	V40157	V40357															
3417	3416	3415	3414	3413	3412	3411	3410	3407	3406	3405	3404	3403	3402	3401	3400	V40160	V40360															
3437	3436	3435	3434	3433	3432	3431	3430	3427	3426	3425	3424	3423	3422	3421	3420	V40161	V40361															
3457	3456	3455	3454	3453	3452	3451	3450	3447	3446	3445	3444	3443	3442	3441	3440	V40162	V40362															
3477	3476	3475	3474	3473	3472	3471	3470	3467	3466	3465	3464	3463	3462	3461	3460	V40163	V40363															
3517	3516	3515	3514	3513	3512	3511	3510	3507	3506	3505	3504	3503	3502	3501	3500	V40164	V40364															
3537	3536	3535	3534	3533	3532	3531	3530	3527	3526	3525	3524	3523	3522	3521	3520	V40165	V40365															
3557	3556	3555	3554	3553	3552	3551	3550	3547	3546	3545	3544	3543	3542	3541	3540	V40166	V40366															
3577	3576	3575	3574	3573	3572	3571	3570	3567	3566	3565	3564	3563	3562	3561	3560	V40167	V40367															
3617	3616	3615	3614	3613	3612	3611	3610	3607	3606	3605	3604	3603	3602	3601	3600	V40170	V40370															
3637	3636	3635	3634	3633	3632	3631	3630	3627	3626	3625	3624	3623	3622	3621	3620	V40171	V40371															
3657	3656	3655	3654	3653	3652	3651	3650	3647	3646	3645	3644	3643	3642	3641	3640	V40172	V40372															
3677	3676	3675	3674	3673	3672	3671	3670	3667	3666	3665	3664	3663	3662	3661	3660	V40173	V40373															
3717	3716	3715	3714	3713	3712	3711	3710	3707	3706	3705	3704	3703	3702	3701	3700	V40174	V40374															
3737	3736	3735	3734	3733	3732	3731	3730	3727	3726	3725	3724	3723	3722	3721	3720	V40175	V40375															
3757	3756	3755	3754	3753	3752	3751	3750	3747	3746	3745	3744	3743	3742	3741	3740	V40176	V40376															
3777	3776	3775	3774	3773	3772	3771	3770	3767	3766	3765	3764	3763	3762	3761	3760	V40177	V40377															

Stage Control / Status Bit Map

This table provides a listing of individual stage control bits associated with each V-memory address bit.

MSB			Stage (S) Control Bits													LSB		Address
15	14	13	12	11	10	9	8	7	6	5	4	3	2	1	0			
017	016	015	014	013	012	011	010	007	006	005	004	003	002	001	000	V41000		
037	036	035	034	033	032	031	030	027	026	025	024	023	022	021	020	V41001		
057	056	055	054	053	052	051	050	047	046	045	044	043	042	041	040	V41002		
077	076	075	074	073	072	071	070	067	066	065	064	063	062	061	060	V41003		
117	116	115	114	113	112	111	110	107	106	105	104	103	102	101	100	V41004		
137	136	135	134	133	132	131	130	127	126	125	124	123	122	121	120	V41005		
157	156	155	154	153	152	151	150	147	146	145	144	143	142	141	140	V41006		
177	176	175	174	173	172	171	170	167	166	165	164	163	162	161	160	V41007		
217	216	215	214	213	212	211	210	207	206	205	204	203	202	201	200	V41010		
237	236	235	234	233	232	231	230	227	226	225	224	223	222	221	220	V41011		
257	256	255	254	253	252	251	250	247	246	245	244	243	242	241	240	V41012		
277	276	275	274	273	272	271	270	267	266	265	264	263	262	261	260	V41013		
317	316	315	314	313	312	311	310	307	306	305	304	303	302	301	300	V41014		
337	336	335	334	333	332	331	330	327	326	325	324	323	322	321	320	V41015		
357	356	355	354	353	352	351	350	347	346	345	344	343	342	341	340	V41016		
377	376	375	374	373	372	371	370	367	366	365	364	363	362	361	360	V41017		
417	416	415	414	413	412	411	410	407	406	405	404	403	402	401	400	V41020		
437	436	435	434	433	432	431	430	427	426	425	424	423	422	421	420	V41021		
457	456	455	454	453	452	451	450	447	446	445	444	443	442	441	440	V41022		
477	476	475	474	473	472	471	470	467	466	465	464	463	462	461	460	V41023		
517	516	515	514	513	512	511	510	507	506	505	504	503	502	501	500	V41024		
537	536	535	534	533	532	531	530	527	526	525	524	523	522	521	520	V41025		
557	556	555	554	553	552	551	550	547	546	545	544	543	542	541	540	V41026		
577	576	575	574	573	572	571	570	567	566	565	564	563	562	561	560	V41027		
617	616	615	614	613	612	611	610	607	606	605	604	603	602	601	600	V41030		
637	636	635	634	633	632	631	630	627	626	625	624	623	622	621	620	V41031		
657	656	655	654	653	652	651	650	647	646	645	644	643	642	641	640	V41032		
677	676	675	674	673	672	671	670	667	666	665	664	663	662	661	660	V41033		
717	716	715	714	713	712	711	710	707	706	705	704	703	702	701	700	V41034		
737	736	735	734	733	732	731	730	727	726	725	724	723	722	721	720	V41035		
757	756	755	754	753	752	751	750	747	746	745	744	743	742	741	740	V41036		
777	776	775	774	773	772	771	770	767	766	765	764	763	762	761	760	V41037		

Chapter 3: CPU Specifications and Operation

MSB		Additional Stage (S) Control Bits (continued)														LSB		Address
15	14	13	12	11	10	9	8	7	6	5	4	3	2	1	0			
1017	1016	1015	1014	1013	1012	1011	1010	1007	1006	1005	1004	1003	1002	1001	1000	V41040		
1037	1036	1035	1034	1033	1032	1031	1030	1027	1026	1025	1024	1023	1022	1021	1020	V41041		
1057	1056	1055	1054	1053	1052	1051	1050	1047	1046	1045	1044	1043	1042	1041	1040	V41042		
1077	1076	1075	1074	1073	1072	1071	1070	1067	1066	1065	1064	1063	1062	1061	1060	V41043		
1117	1116	1115	1114	1113	1112	1111	1110	1107	1106	1105	1104	1103	1102	1101	1100	V41044		
1137	1136	1135	1134	1133	1132	1131	1130	1127	1126	1125	1124	1123	1122	1121	1120	V41045		
1157	1156	1155	1154	1153	1152	1151	1150	1147	1146	1145	1144	1143	1142	1141	1140	V41046		
1177	1176	1175	1174	1173	1172	1171	1170	1167	1166	1165	1164	1163	1162	1161	1160	V41047		
1217	1216	1215	1214	1213	1212	1211	1210	1207	1206	1205	1204	1203	1202	1201	1200	V41050		
1237	1236	1235	1234	1233	1232	1231	1230	1227	1226	1225	1224	1223	1222	1221	1220	V41051		
1257	1256	1255	1254	1253	1252	1251	1250	1247	1246	1245	1244	1243	1242	1241	1240	V41052		
1277	1276	1275	1274	1273	1272	1271	1270	1267	1266	1265	1264	1263	1262	1261	1260	V41053		
1317	1316	1315	1314	1313	1312	1311	1310	1307	1306	1305	1304	1303	1302	1301	1300	V41054		
1337	1336	1335	1334	1333	1332	1331	1330	1327	1326	1325	1324	1323	1322	1321	1320	V41055		
1357	1356	1355	1354	1353	1352	1351	1350	1347	1346	1345	1344	1343	1342	1341	1340	V41056		
1377	1376	1375	1374	1373	1372	1371	1370	1367	1366	1365	1364	1363	1362	1361	1360	V41057		
1417	1416	1415	1414	1413	1412	1411	1410	1407	1406	1405	1404	1403	1402	1401	1400	V41060		
1437	1436	1435	1434	1433	1432	1431	1430	1427	1426	1425	1424	1423	1422	1421	1420	V41061		
1457	1456	1455	1454	1453	1452	1451	1450	1447	1446	1445	1444	1443	1442	1441	1440	V41062		
1477	1476	1475	1474	1473	1472	1471	1470	1467	1466	1465	1464	1463	1462	1461	1460	V41063		
1517	1516	1515	1514	1513	1512	1511	1510	1507	1506	1505	1504	1503	1502	1501	1500	V41064		
1537	1536	1535	1534	1533	1532	1531	1530	1527	1526	1525	1524	1523	1522	1521	1520	V41065		
1557	1556	1555	1554	1553	1552	1551	1550	1547	1546	1545	1544	1543	1542	1541	1540	V41066		
1577	1576	1575	1574	1573	1572	1571	1570	1567	1566	1565	1564	1563	1562	1561	1560	V41067		
1617	1616	1615	1614	1613	1612	1611	1610	1607	1606	1605	1604	1603	1602	1601	1600	V41070		
1637	1636	1635	1634	1633	1632	1631	1630	1627	1626	1625	1624	1623	1622	1621	1620	V41071		
1657	1656	1655	1654	1653	1652	1651	1650	1647	1646	1645	1644	1643	1642	1641	1640	V41072		
1677	1676	1675	1674	1673	1672	1671	1670	1667	1666	1665	1664	1663	1662	1661	1660	V41073		
1717	1716	1715	1714	1713	1712	1711	1710	1707	1706	1705	1704	1703	1702	1701	1700	V41074		
1737	1736	1735	1734	1733	1732	1731	1730	1727	1726	1725	1724	1723	1722	1721	1720	V41075		
1757	1756	1755	1754	1753	1752	1751	1750	1747	1746	1745	1744	1743	1742	1741	1740	V41076		
1777	1776	1775	1774	1773	1772	1771	1770	1767	1766	1765	1764	1763	1762	1761	1760	V41077		