



Errata Sheet

This Errata Sheet contains corrections or changes made after the publication of this manual.

Product Family:	DL405	Date:	September 2018
Manual Number	D4-DCM-M		
Revision and Date	1st Edition, Rev. A; June 1998		

Changes to Page 7. Specifications

Operating Specifications

Revise the row 3 “Location of module” specification as follows:

Change “CPU base only, any slot except Slot 0 or CPU slot” to read “CPU base only, maximum 7”.

Changes to Page 16. Building the Communication Cable

Consideration 4: Cable Specifications

In the first paragraph, replace the sentence “A cable constructed equivalent to Belden 9855 will be sufficient” with the following:

“AutomationDirect L19772-1 (Belden 8102) or equivalent will be sufficient”.

Changes to Page 17. Building the Communication Cable (continued)

Multi-drop Termination Resistors

In the first paragraph, replace the last sentence: “For example, a typical 22 AWG solid conductor cable with 4.5 twists per foot has a typical impedance of about 120 ohms.” with the following:

“For example, AutomationDirect L19772-1 (Belden 8102) or equivalent has a nominal characteristic impedance of 100 ohms”.

Also on page 17, change two callouts in the upper Line-to-Line Termination drawing. Change the callouts saying “120 ohm Resistor” to “100 Ohms Resistor”

Change two callouts in the lower Line-to-Ground Termination drawing. Change the callouts saying “62 ohm Resistors” to “51 Ohms Resistors”

Introduction

In This Section. . . .

- Overview
 - DCM Hardware
 - Applications
 - Specifications
 - Using the DCM – Five Steps
-

Overview

The Purpose of this Manual

This manual is designed to allow you to setup and install your DL405 Data Communications Module (DCM). This is the only manual you will need if you are using the DCM as an extra general purpose communication port for your DL405 PLC system. If you plan on using the DCM as a network master or slave on a **DirectNET** network, we suggest that you read the **DirectNET** manual first. The **DirectNET** manual provides detailed descriptions of network configurations, protocol, and the PLC programs that are necessary to control communications with the DCMs.

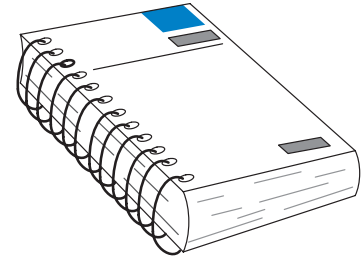

If you plan on using a personal computer as the network master, it may be helpful to read the **DirectNET** manual first. In either case, the **DirectNET** manual can be useful because it provides detailed descriptions of network configurations, various cable connections, etc.

Supplemental Manuals

Depending on which products you have purchased, there may be other manuals that are necessary or helpful for your application. These are some suggested manuals:

User Manuals

- **DirectNET** Network Guide part number DA-DNET-M
- **DirectSoft** Programming Software part number DA-DSOFT-M

If you plan to use your D4-DCM to communicate with another PLC, you will need the appropriate user manual for the other PLC.

If you plan to use your D4-DCM module as an interface to HMI or PC Control software or to an Operator Interface panel, you will need to refer to the documentation for that product.

Who Should Read this Manual

If you need an additional communications port for your DL205 PLC and you understand the basics of installing and programming PLCs, this is the right manual for you. This manual gives you the information you need to set up an active port on the D4-DCM module.

Quality Technical Manuals and Technical Support

We strive to make our manuals the best in the industry. We rely on your feedback to let us know if we are reaching our goal. If you cannot find the solution to your particular application, or, if for any reason you need additional assistance, please call us at **800-633-0405**. Our technical support group is glad to work with you in answering your questions. They are **available weekdays from 9:00 a.m. to 6:00 p.m. Eastern Time**. You can also contact us on the **worldwide web** at:

<http://www.plcdirect.com> (PLC**Direct** Web site for general info/file transfers)

You can also find a variety of support solutions at our 24-hour per day **BBS** at:

770-844-4209

If you find a problem with any of our products, services, or manuals, please fill out and return the 'Suggestions' card that came with this manual.

Steps

The main contents of this manual are organized into five steps:

**Introduction**

tells you about the Data Communication Module and its uses. It lists other manuals you may need and tells you how to get additional technical assistance, if necessary.

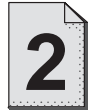
**Build the Cable**

guides you through building the necessary communication cable, covering physical and electrical specifications.

**Set the DCM Switches**

guides you through the setup of the rotary and DIP switches to select communication parameters and network addressing. It shows the proper method of inserting the module into the base.

**Install the DCM and Start the Network**

tells you what to consider when laying out your network cable and how to terminate the individual conductors at the networked devices. It gives you specific cabling examples, showing pinouts for each device.

**Verify and Troubleshoot**

introduces the use of the DCM's status indicator lights as a diagnostic tool. It gives you status indicator light patterns to help you identify problems that could be preventing communications.

Appendix

Additional reference information for the D4-DCM is available in this appendix:

**RLL Communications Programs**

provides helpful examples of Ladder Logic programs for DCM communications.

DCM Hardware

The following diagram shows the major DCM components. The address selection switches and the communication dipperswitches are of special importance.

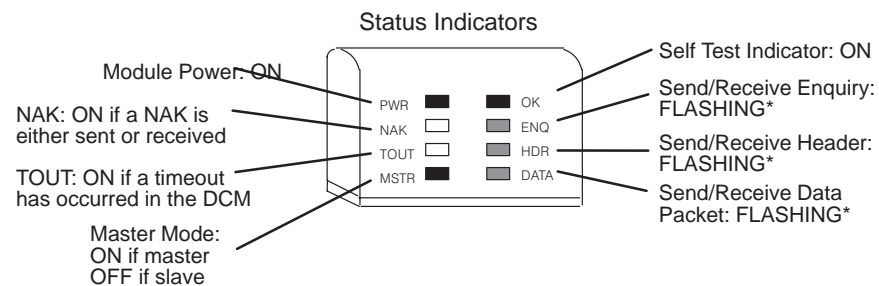
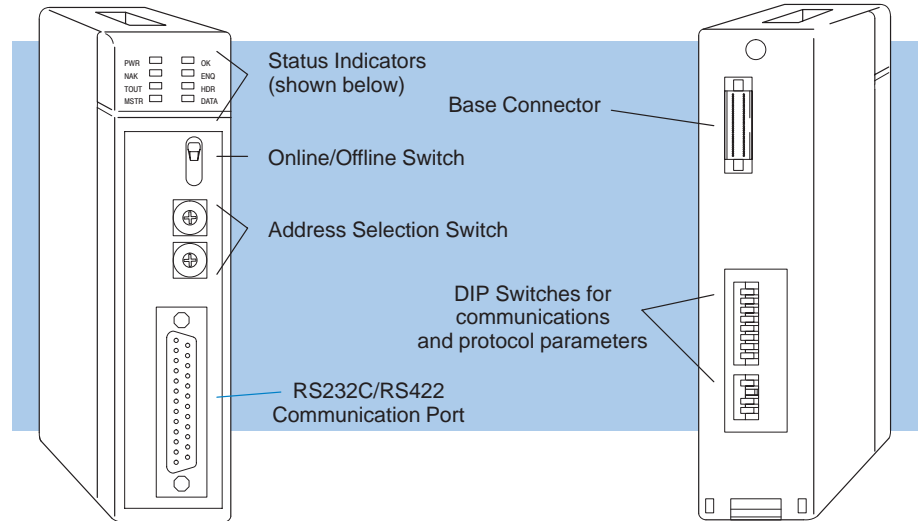

DCM Uses

The DL405 Data Communications Module (DCM) is a general purpose communications interface for the DL405 family of Programmable Logic Controllers (PLCs). This module is primarily used for three reasons.

- As a network interface to a **DirectNET** network
- As an extra general purpose communications port to connect a personal computer or operator interface
- As a network interface to a Modbus[®] network using the RTU protocol

The following pages provide an overview of these uses, along with the information you need to connect the DCM.

Applications

As a *DirectNET* Interface

The DCM can be used as a network interface for applications that require data to be shared between PLCs, or between PLCs and an intelligent device (such as a host computer). The DCM easily connects to *DirectNET*. This network allows you to upload or download virtually any type of system data including Timer/Counter data, I/O information, and V-memory information.

Using a DCM as part of a PLC Network Master — The DCM can be used in a DL405 PLC station that is serving as a network master. (A master is the network station that initiates requests for data from other stations on the network). The DCM takes communication requests issued from the PLC program and automatically converts these requests into network commands that read data from or write data to another network station.

The PLC program is really very simple and only requires a few instructions. You do not have to be a PLC programming guru to use the network. Appendix A provides an overview of the instructions used. (If you want even more information, see the *DirectNET* Manual).

Using a DCM as part of a PLC Network Slave — The DCM can also be used in a DL405 PLC station that is serving as a network slave station. In this case, the DCM “listens” to the network for any messages that contain the DCM’s address. The DCM deciphers the network commands, carries out the request to read or write data, and sends confirmation and/or information to the master station.

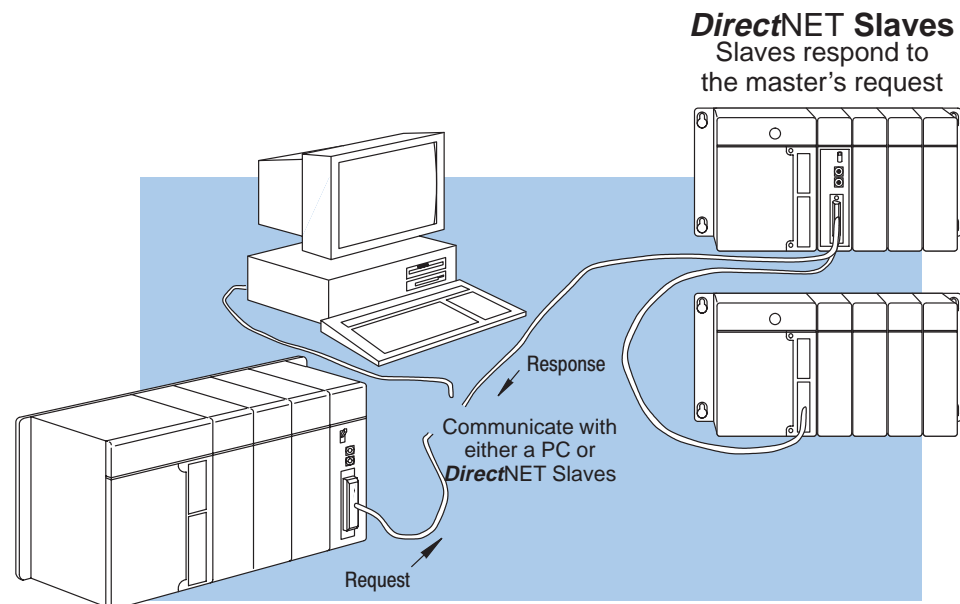

As an Extra Communication Port

As an extra communication port, the DCM has specifications similar to the bottom port on the DL405 PLCs. Plus, the DCM can communicate at higher baud rates. If you can connect a device to the bottom port on the DL405 PLC, then you can also connect the same device to the DCM. These devices can be a variety of things, such as operator interfaces or personal computers.

Since the DCM does not require any programming, you can simply set the DCM communication parameters, connect the appropriate RS232C or RS422 cables, and start transferring data.

Quickly add extra Communication ports*

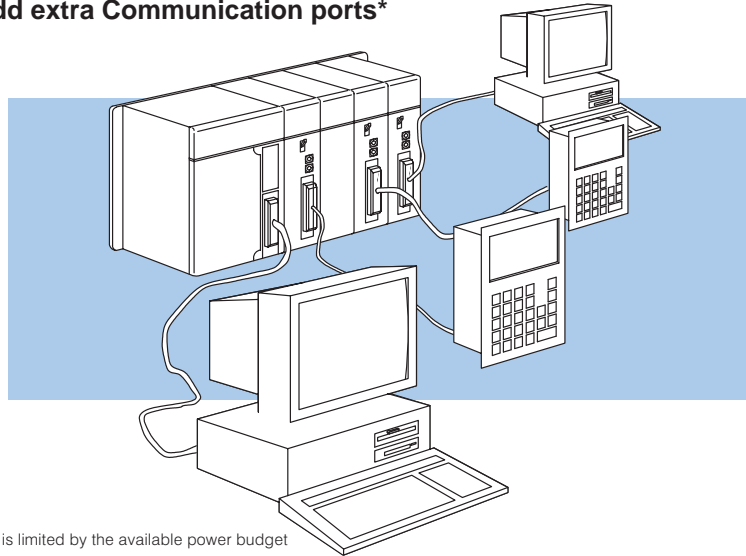

* Number of DCMs is limited by the available power budget

As a Modbus® Network Interface

The DCM can be used as a slave station interface to connect your DL405 system to the Modbus® network using the Modbus® RTU protocol. The host system must be capable of issuing the Modbus® commands to read or write the appropriate data. This manual does not describe the Modbus® protocol. You must reference the Gould Modbus® Protocol Reference Guide for details (P1-MBUS-300 Rev. B). There may be more recent editions of this manual, so check with your Modbus® supplier before ordering the documentation. (A cross reference for the Data Types is supplied later in this manual).

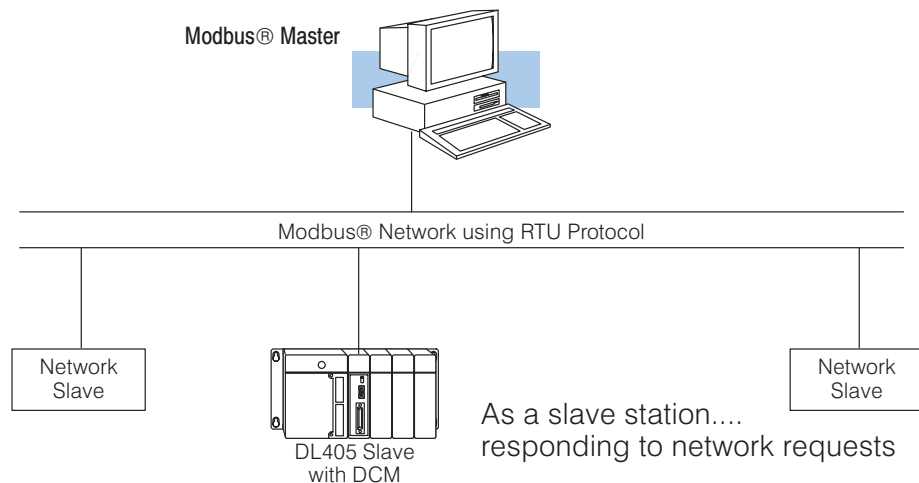

Specifications

Environmental Specifications

Operating Temperature	32° F to 140° F (0° to 60° C)
Storage Temperature	-4° F to 158° F (-20° to 80° C)
Operating Humidity	5 to 95% (non-condensing)
Air Composition	No corrosive gases permitted
Vibration	MIL STD 810C 514.2
Shock	MIL STD 810C 516.2
Voltage Isolation	1500 VAC, 1 minute duration
Insulation Resistance	10M ohms at 500 VDC
Noise	NEMA ICS3-304

Operating Specifications

Power Budget Requirement	500 ma @ 5 VDC
Maximum number of modules	limited only by power budget
Location of module	CPU base only any slot except Slot 0 or CPU slot
Interface	Serial RS232C / RS422 half-duplex, DTE, Asynchronous, 8 bits/character
Baud Rates	300 to 38.4K baud, switch selectable
Maximum Distance	RS232C – 49ft (15 meters) RS422 – 3300 feet (1000 meters)
Protocol	Direct NET ¹ K-sequence (proprietary) MODBUS® RTU
Diagnostics	Automatic check of ROM/RAM, communications, switch settings, and LEDs

Change to:
"CPU base only,
maximum 7"

Note 1: Also compatible with Hostlink and/or CCM2 protocols. These names were used by previous vendors of compatible Koyo designed products.

Using your DCM– Five Steps

Complete the following steps to connect the DCM.

STEP 1. Familiarize yourself with the communications options of DCM in the Introduction.

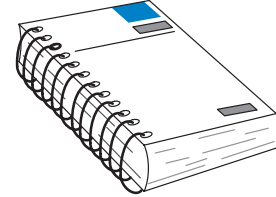

STEP 2. Build the communication cable that fits your needs.

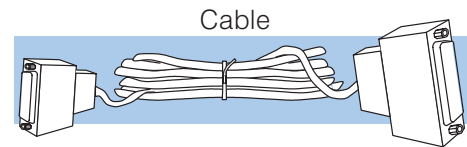

STEP 3. Set the DCM switches. (Baud rate, parity, etc).

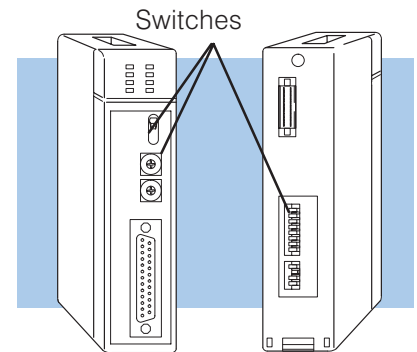

STEP 4. Install the DCM.

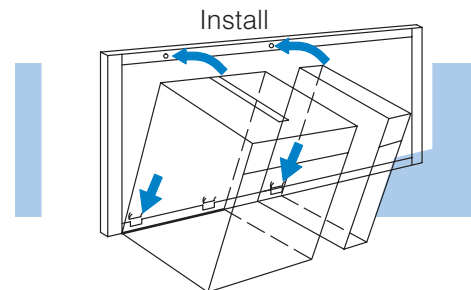

STEP 5. Verify correct network operation.

Verify (Troubleshooting)

