



Amplifier for synthetic optical fibers

NPN type - light/dark-ON output

Part number

DFT-AN-1F

Sensing range (on mat white paper)
with CF-DB1-20

200 mm

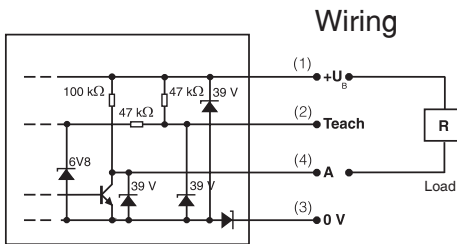

Wiring

U_B 10 ... 30 VDC
 I_A 200 mA max.

Housing PBTP

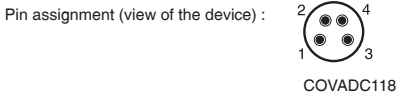

Dimensions:

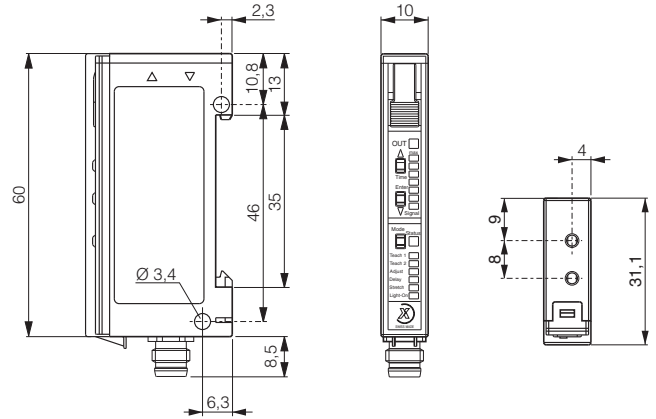

These proximity switches **must not be used** in applications where the **safety of people** is dependent on their functioning. Terms of delivery and rights to change design reserved.

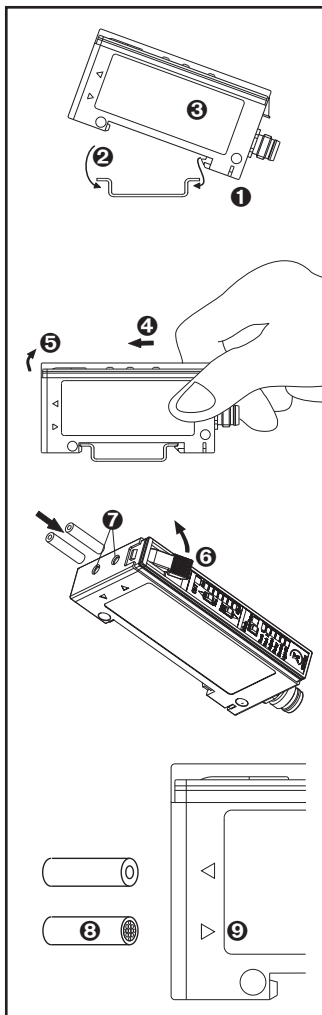

Device mounting

- Mounting of the device is most easily effected by snapping ① / ② onto a top-hat rail (according to DIN / EN 50022).
- Alternatively, fixing can be effected using M3 screws through the fixing holes ③ provided.
- To remove the device from the rail, push towards the optical fiber ④, and lift ⑤.

Fixing the optical fibers

- Lift catch ⑥.
- Insert the optical fibers through the two holes ⑦ provided into the device.
- Lower catch ⑥.

Important:

- When inserting the optical fibers, the resistance of the device's internal O-ring seal must be overcome.
- The optical fibers must be fed right to the stop without fail.
- The optical fibers must not be crushed.
- The sequence (emitter / receiver) is usually immaterial, however:
- With coaxial optical fibers (LFP-1003-020), the optical fiber bundle ⑧ must be connected on the receiver side ⑨. The emitter and receiver openings are marked with arrows on the housing.

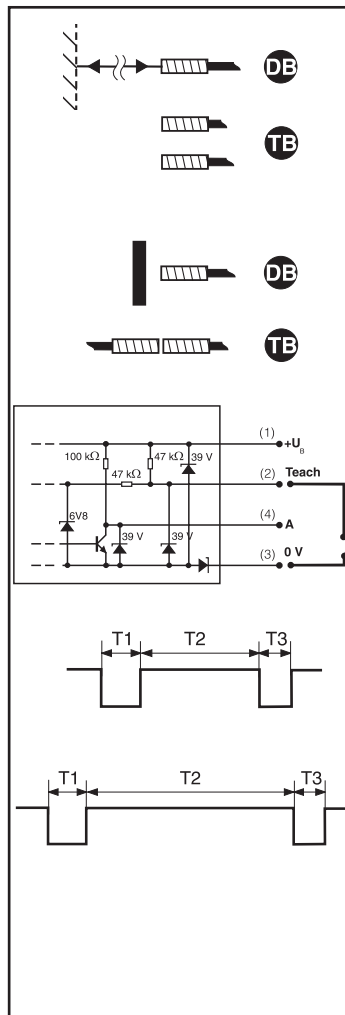

Max. distance / sensitivity

- Ⓛ Remove target and background. Execute Teach 1.
- Ⓧ Place emitter and receiver so that no light is transmitted. Execute Teach 1.

Min. distance / sensitivity

- Ⓛ Place fiber-optic head about 5 mm from white paper. Execute Teach 1.
- Ⓧ Place emitter and receiver in direct contact so that a maximum of light is transmitted. Execute Teach 1.

Remote teach launching

Launch by L signals or by closing a contact at the "Teach" input.

- **Teach 1**
 - Ⓛ : Remove target.
 - Ⓧ : Position target.

Send pulses T1 and T3.
Timing: T1, T3 = 0.5 ... 2 sec
T2 = 1.5 ... 2 sec
- **Teach 2**
 - Ⓛ : Position target and background.
 - Ⓧ : Remove target.
 - Ⓛ : Remove target, leave background in position.
 - Ⓧ : Position target.

Send pulse T3.
Timing: T1, T3 = 0.5 ... 2 sec
T2 ≥ 3 sec

Teach 1

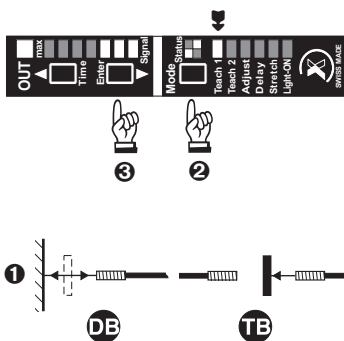

Setting of the sensing range (teach) is carried out in one cycle, and can be manually fine adjusted at any time (using the **Adjust** function, see below).

- Diffuse sensors **DB** : Teach only takes place on the background. The target is not taken into consideration. The device adjusts itself automatically to approximately 80% of the background distance.
- Through-beam sensors **TB** : Teach is effected with a target located in the beam. The device automatically adjusts itself so that approximately 80% of the darkening created by the target triggers the switching process.

- 1 Diffuse sensors **DB** : Remove target, leave or place background in position.
Through-beam sensors **TB** : Leave or place target in position.
- 2 Activate **Teach 1** mode by pressing the **Mode** key twice.
- 3 Press **▶/Enter** key. Teach successful: The **Status** LED blinks green for 5 seconds. The device is ready for use.

Teach 2

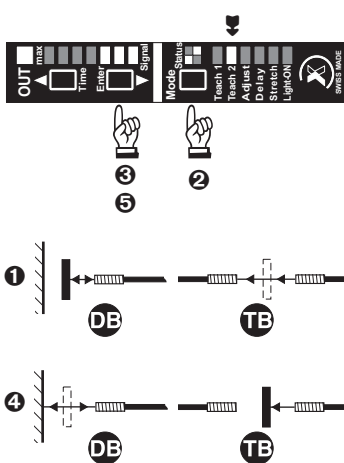

Setting of the sensing range (teach) is carried out in two cycles, and can be manually fine adjusted at any time (using the **Adjust** function, see below).

- Diffuse sensors **DB** : Teach is effected firstly on the target, then on the background. The device automatically adjusts itself to a distance between that of the target and that of the background.
- Through-beam sensors **TB** : Teach takes place firstly without the target, then with the target located in the beam. The device automatically adjusts itself to part of the darkening created by the target.

- 1 Diffuse sensors **DB** : Position (or leave) target and background.
Through-beam sensors **TB** : Remove target.
- 2 Activate **Teach 2** mode by pressing the **Mode** key 3 times.
- 3 Press **▶/Enter** key, the first cycle begins. Teach successful: The **Status** LED lights up green. The device is ready for the second cycle.
- 4 Diffuse sensors **DB** : Remove target, leave background in position
Through-beam sensors **TB** : Position target.
- 5 Press **▶/Enter** key, the second cycle begins. Teach successful: The **Status** LED blinks green for 5 seconds. The device is ready for use.

Adjust

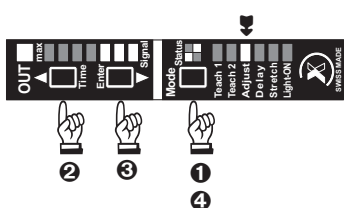

The detection zone can be set manually, or when set by the teach function, can be manually fine adjusted. All activated functions (except delay and stretch) are in operation, and the output switched.

- 1 Activate **Adjust** mode by pressing the **Mode** key 4 times.
- 2 For each press on the **◀/Time** key, the current detection zone is increased by 1 increment.
- 3 For each press on the **▶/Enter** key, the current detection zone is reduced by 1 increment.
- 4 Return to working mode by pressing the **Mode** key.

Delay

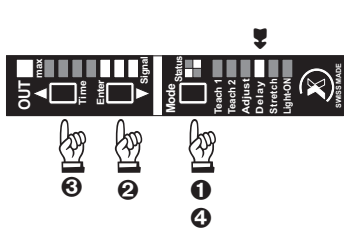

Switching of the output is delayed by the set time. In this way, short-term disturbances can be suppressed. All activated functions (except delay and stretch) are in operation, and the output switches.

- 1 Activate **Delay** mode by pressing the **Mode** key 5 times.
- 2 Pressing the **▶/Enter** key switches the delay (factory setting: 10 msec) on or off. The current status is shown by the **Status** LED (green = **Delay** switched on).
- 3 Each time the **◀/Time** key is pressed, the delay time is increased by 10 msec, up to a maximum of 150 msec.
- 4 Return to working mode by pressing the **Mode** key.

Stretch

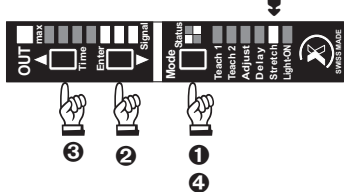

Switching of the output is stretched by the set time. In this way, even short pulses can be detected. All activated functions (except delay and stretch) are in operation, and the output switches.

- 1 Activate **Stretch** mode by pressing the **Mode** key 6 times.
- 2 Pressing the **▶/Enter** key switches the stretching (factory setting: 10 msec) on or off. The current status is shown by the **Status** LED (green = **Stretch** switched on).
- 3 Each time the **◀/Time** key is pressed, the stretch time is increased by 10 msec, up to a maximum of 150 msec.
- 4 Return to working mode by pressing the **Mode** key.

Light/Dark-ON

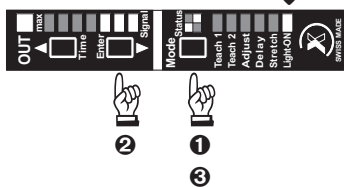

Setting of the output function (factory setting **Light-ON**, i.e. light switching in operation as diffuse sensor, dark switching as through-beam sensor).

- 1 Activate **Light-ON** mode by pressing the **Mode** key 7 times. The current status is shown by the **Status** LED (Light-ON ➤ LED off / Dark-ON ➤ LED on).
- 2 Pressing the **▶/Enter** key changes the output function.
- 3 Return to working mode by pressing the **Mode** key.

Cutting the optical fibers

- Cut synthetic optical fibers to the desired length. Use only the cutting tool delivered with the optical fibers.

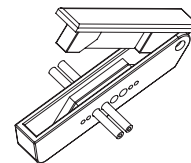

- A maximum of 3 cuts should be made per cutting-tool hole.

Separating the optical fibers

- Grasp the optical fiber ends with both hands and pull both strands apart to a length of about 50 mm.
- According to the type (above all for thin-fiber executions), prior twisting helps.

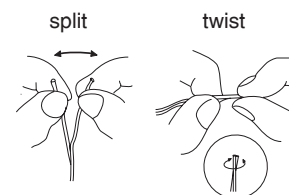

Optical fiber mounting

(All diameters refer to the optical diameter.)

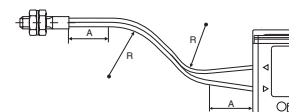

- No bending should occur in zone "A".
Fiber Ø 1 mm A ≥ 20 mm
Fiber Ø 0.5 mm A ≥ 10 mm
Fiber Ø 1.5 mm A ≥ 30 mm
High-flexibility fiber A ≥ 5 mm
- The bending radius should not be less than "R".
Fiber Ø 1 mm R ≥ 25 mm
Fiber Ø 0.5 mm R ≥ 10 mm
Fiber Ø 1.5 mm R ≥ 40 mm
High-flexibility fiber R ≥ 2 mm
- Bendable light-outlet tubes should be bent as little as possible; best bent around a cylindrical object.
- Maximum 3 bends.

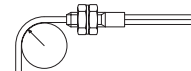

- Tube Ø 2.5 mm r ≥ 20 mm
Tube Ø 1.2 mm r ≥ 10 mm

This product is protected by one or several of the following US patents: 5 182 612, 5 767 444, 5 675 143, 5 764 351, 6 031 430, 6 130 489, 6 133 654, 6 133 988. Further patents pending