

DOCUMENTATION



In This Chapter...

Turn Documentation On and Off.....	6-2
Using the Documentation Editor	6-4
Documenting and Assigning Nicknames	6-6
Entering Rung Comments	6-9
Entering Stage Comments	6-12
Importing and Exporting	6-14
Prevent Documentation Loss	6-28

Turn Documentation On and Off

Documentation is the text associated with the components and structure of a *DirectSOFT6* program which is added for greater clarity. It may refer to the elements, wiring, rungs or stages. All documentation options are turned ON by default when the **Options** dialog is first opened.

The Options Dialog

DirectSOFT6 allows the programmer to turn ON/OFF the documentation in each available view. A quick way to open the Options dialog is to place the mouse cursor in the displayed view and right click the mouse. A pop-up window will appear with Options as one of the selections. Select Options and the dialog will appear like the one shown below. When the dialog opens, the Ladder tab is in view by default. The other views can be selected by clicking on the tab at the top of the dialog.

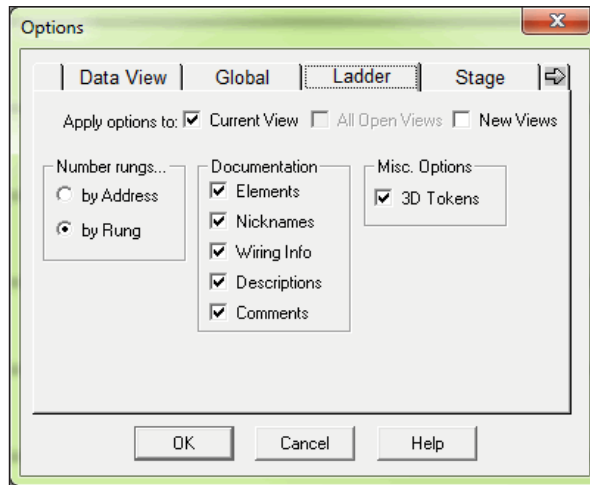

The Ladder tab is showing all of the documentation types checked. Leaving each selection checked turns ON that documentation type to be shown in the program. Unchecking the documentation type will turn it OFF in the program. Most of the Options dialog features have been discussed in Chapter 4. For turning the documentation ON/OFF, only the Ladder, Stage, XRef and Data View (under Doc tab) options need to be accessed.

Documentation Selections

Most documentation refers to individual elements, therefore, it is specific in nature. Listed below are four types of documentation

- **Elements** – the references for the individual elements, i.e. X1, Y10, etc.
- **Nicknames** – these are alpha-numeric names that are used for the various types of program elements. It is usually easier to remember the name *Start Switch* than it is to remember that X1 is the input for the switch.
- **Descriptions** – detailed description of an element. This can also be used to add brief trouble-shooting steps, etc.
- **Wiring Info** – this can be used to identify panel wiring for the project.

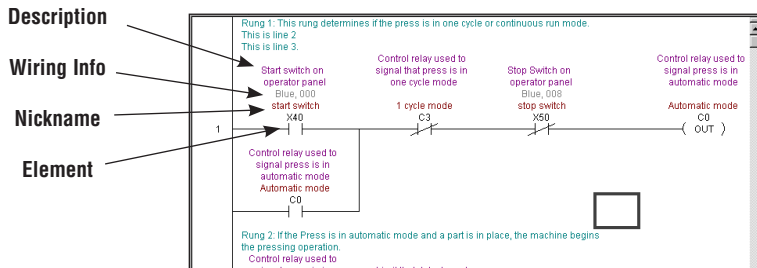

General Documentation

Comments are general descriptions that are best suited for descriptions of a program rung, or a section of the program.

- **Rung Comments** – rung comments are assigned to an individual rung.
- **Stage Comments** – if you are using the Stage instructions, you can also add comments that describe the contents of any stage.

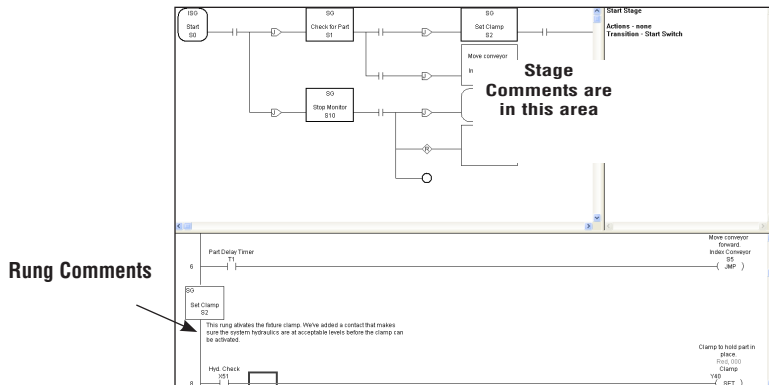

Using the Documentation Editor

Nicknames, wiring information and descriptions for program elements are entered using the Documentation Editor. The editor can be accessed using **Tools > Documentation Editor** on the Menu bar, **Ctrl + D** or by pressing the Documentation button on the Tools toolbar.

The screenshot shows the 'Documentation Editor' window with a toolbar at the top containing navigation buttons (left arrow, R, left double arrow, left arrow, right arrow, right double arrow, R, right arrow, home, end) and a table below. The table has four columns: Element, Nickname, Wiring Info, and Description. It lists elements X40 through X47 with their respective nicknames, wiring information, and descriptions.

Element	Nickname	Wiring Info	Description
X40	Start Switch	Blue, 000	Start Switch on operator panel.
X41	Part Present	Blue, 001	Limit that detects part in fixture
X42	Clamp Locked	Blue, 002	Confirms that clamp has securely locked the part in place.
X43	Clamp Unlocked	Blue, 003	Confirms that the clamp is unlocked.
X44	Lower Limit	Blue, 004	Lower arbor limit. Part has been pressed.
X45	Upper Limit	Blue, 005	Upper arbor limit.
X46	Conveyor Confirm	Blue, 006	Confirms that conveyor actually traveled forward.
X47	One Cycle Switch	Blue, 007	Switch on operator panel selects one-cycle or automatic operation.

Using the Scroll Buttons

There are scroll command buttons (arrowheads) located at the top of the editor. They are shown (both directions) as ►, ►►, ►R, ►|, etc. Each button has a unique function:

- – Moves one element forward.
- – Moves one page forward.
- R – Moves to the beginning of the next data type (X, Y, C, etc.)
- | – Moves to the last document type.
- ◄ – Moves one element back.
- ◄◄ – Moves one page back.
- R◄ – Move to the beginning of the previous data type.
- |◄ – Moves to the beginning of the first document point.

Copying Documentation Between Elements

If it becomes necessary to use the Documentation editor, all of the familiar Windows keyboard shortcuts (copy, cut, paste, etc.) can be used within the editor. For example, if there is a lengthy description for a point, and other points are similar, the information can be copied. The following example will demonstrate how this is accomplished.

1. Position the cursor in the cell to be copied.
2. Double click to highlight the information.
3. Press **Ctrl + C** to copy the information in the cell.
4. Move the cursor to the element cell where the information is to be copied to. (Use the **Find** button, **Ctrl + F** shortcut or scroll).
5. With the cursor in position to paste the information, press **Ctrl + V**.

Element	Nickname	Wiring Info	Description
X40	Start Switch	Blue, 000	Start Switch on operator panel.
X41	Part Present	Blue, 001	Limit that detects part in fixture
X42	Clamp Locked	Blue, 002	Confirms that clamp has securely locked the part in place.
X43	Clamp Unlocked	Blue, 003	Confirms that the clamp is unlocked.
X44	Lower Limit	Blue, 004	Lower arbor limit. Part has been pressed.
X45	Upper Limit	Blue, 005	Upper arbor limit.
X46	Conveyor Confirm	Blue, 006	Confirms that conveyor actually traveled forward.
X47	One Cycle Switch	Blue, 007	Switch on operator panel selects one-cycle or automatic operation.



NOTE: When copying a nickname, the new nickname will have a “?” before and after the newly pasted entry. This occurs because each nickname must be unique.

Documenting and Assigning Nicknames

Create an Unassigned Nickname

Element nicknames are used more often than any other type of documentation. As a program is developed using nicknames, element references do not have to be entered when a contact, coil, etc. is entered. Wiring information and descriptions can also be entered without knowing the actual element reference.

Unassigned nickname is entered (red indicator remains on).

Click OK

Dialog appears when a nickname is entered without being linked to an element.

The nickname is accepted without being linked to an element.

Assign the Nickname to an Element



If unassigned nicknames have been created in the program, element references must be assigned before the program can be written to the PLC (the PLC does not recognize nicknames, only element references). The **Assign Nicknames** dialog is used to assign nicknames to element references. A quick way to open the dialog is to either press **F9** (hotkey) or the **Assign Nicknames** button (if the Tools toolbar is displayed). Another way is to use **Tools > Assign Nicknames** from the Menu bar. Also, if the **Element Browser** is open, nickname information can be assigned by clicking on the **Assign Nicknames** button in the Element Browser and the Assign Nicknames dialog will appear as shown on the facing page.



Tip: Nicknames can be compiled and saved to disk; and then assigned later, just before downloading to the PLC.

Open the Element Browser

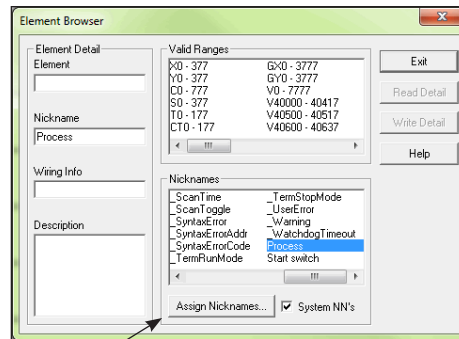

Click here to open the Assign Nicknames dialog.

The **Assign Nickname** dialog will appear with the list of unassigned nicknames appearing in the **Source Nickname** column. Select the nickname in the list and enter the element reference for the nickname in the **Source Element** Column.

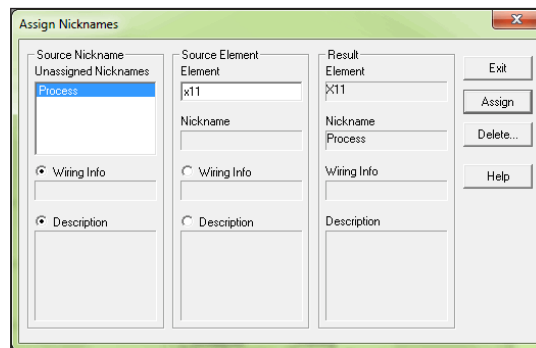

The reference will be duplicated in the **Result** column to help avoid accidental entries. Press **Assign** and the following dialog will appear as a confirmation of the element entry.

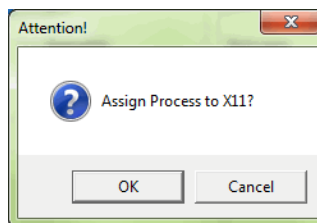

If the reference entered is correct, click **OK**. The Element Browser will be in view again so that wiring information and a description, if any, can be added. Pressing **Exit** will close the browser and the program will have the new element in the program as shown below.

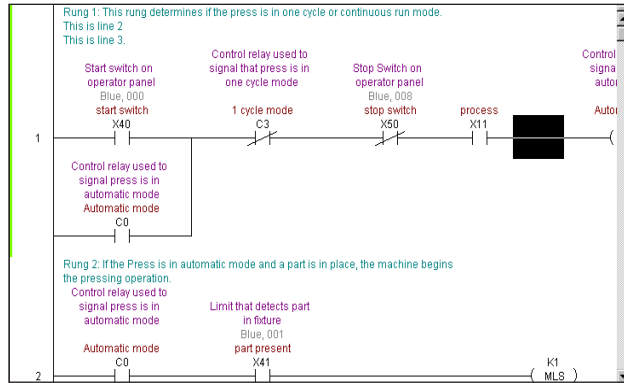

Entering Rung Comments



Each rung in a *DirectSOFT6* program can have associated comments. Unlike some programming packages from other vendors, the comments are not tied to the outputs. Instead, the comments remain with the rung where the comments are added regardless if other rungs are deleted before a commented rung. To edit a comment, the cursor must be on the rung to where it is to be added. Now, either press the keyboard shortcut **Ctrl + K**, **Tools > Comment Editor** on the Menu bar or press the **Comments** button on the Tools toolbar if it is displayed. The **Edit Comments** dialog, shown below, will appear.

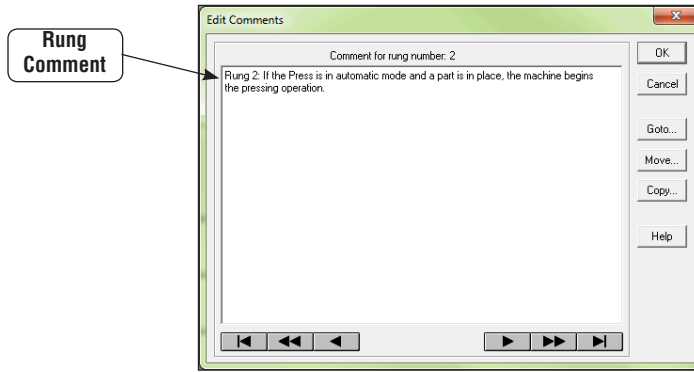

Comments are Free-form

The appropriate comment can be added as necessary. The Ladder view is a full screen editor, therefore, backspacing the entire comment is not necessary to fix a spelling error. Instead, position the cursor over the word to be edited and double-click the left mouse button to highlight the word, then type in the corrected word.

Selecting Rungs for Comments

Once you have edited a rung comment you can use the **Page Up** and the **Page Down** keyboard buttons to scroll to another rung comment to edit. A specific rung can be found by using the **Goto** button on the editor dialog.

Using the Scroll Buttons

There are scroll command button (arrowheads) located at the bottom of the dialog. They are shown for both directions as ►, ►►, ►|, etc. Each button performs a different function:

- – Moves to the next rung comment.
- – Moves ahead five rung comments.
- | – Moves to the comment for the last rung.
- ◄ – Moves to the previous rung comment.
- ◄◄ – Moves back five rung comments.
- |◄ – Moves to the comment for the first rung.

Click on the **OK** button after entering the rung comments.

Use the Editing Keys

The keyboard shortcut keys can be used to copy, cut and paste comments between rungs.

1. Position the cursor at the beginning of the text to be copied or cut.
2. Press and hold the left mouse button and move the cursor to highlight the text, then release the button. The **Shift + Arrow** keys can also be used to highlight the text.
3. Use the **Ctrl + C** keys to copy the text or the **Ctrl + X** keys to cut the text.
4. Locate the rung where the information is to be pasted (Use **Previous**, **Next** or **Goto**).
5. Position the cursor where the text is to be pasted and click the left mouse button, then press **Ctrl + V** to paste the text.
6. The **Delete** key can also be used to delete text.

Move Rung Comments

Rung comments can easily be moved from one rung to another with **DirectSOFT6**. This feature is useful after one or more rungs have been inserted by a handheld programmer or by another computer which did not have the documentation files available. The Move comment feature can be used to match the comment(s) with the correct rung(s). Comments can be moved for a single rung or a group of rungs. To move comments, click on the **Move** button on the dialog. The window will appear within the dialog.

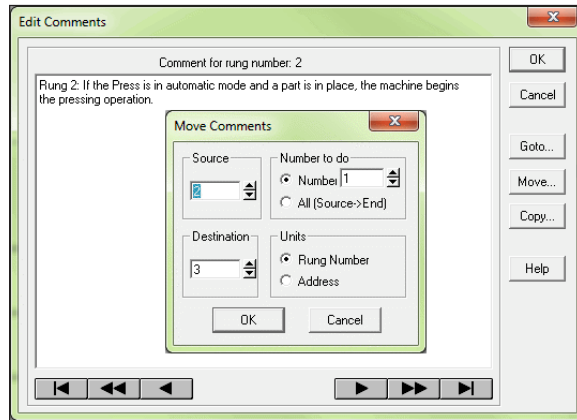

Fill in the appropriate fields to specify the source and destination for moving a comment.

- **Source** – This is the beginning of the group of comments to be moved. Enter the rung number (or address) of the rung with the comments to move.
- **Destination** – Enter the rung number (or address) of the rung to move the comments to.
- **Number to Move** – Chose **All** or enter the number of comments to move from the source to the destination.
- **Units** – Select either **Rung Number** or **Address**.

Press **OK** to complete the move or **Cancel** to exit without performing the operation.

NOTE: You can overwrite existing rung comments with this feature. **DirectSOFT6** always provides a confirmation prompt before it completes the move. The message reminds you that any overlapping comments will be changed. This message will appear even if there are no overlapping rungs. It is a reminder that existing rungs can be overwritten.



Entering Stage Comments

Use Stage View

If you are using Stage instructions, comments can be entered for each stage. The Stage View must be displayed in order to enter the comments. With a Ladder View open, the Stage View is opened by clicking on **View > Stage View** on the Menu bar.

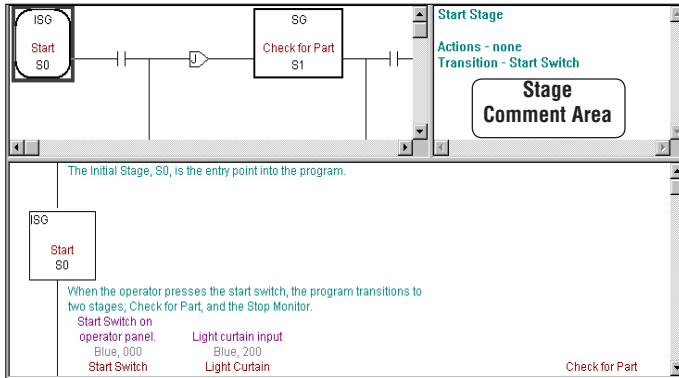

In order to enter Stage comments, the cursor must be positioned in either of the upper quadrants of the Stage view. To open the comment editor, either click on the keyboard shortcut **Ctrl + K**, **Tools > Comment Editor** on the Menu bar or press the **Comments** button on the Tools toolbar if it is displayed. The Comment editor can also be opened by double-clicking the left mouse button with the cursor positioned in the stage comment area. Note that the comment editor is for Stage comments.

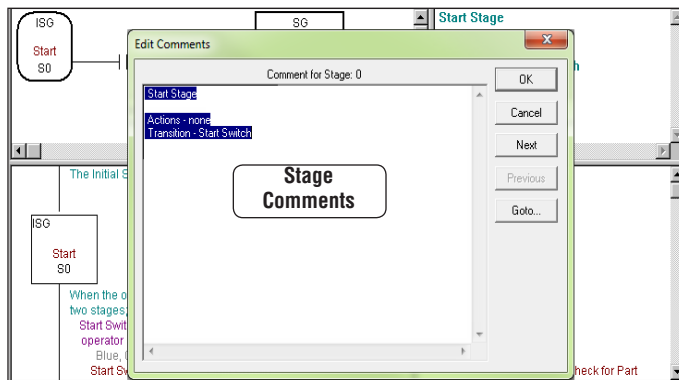

Comments are Free-form

A new comment can be edited immediately. The appropriate comment can be added as necessary.

Selecting Stages to Comment

Once you have edited a rung comment you can use the **Page Up** and the **Page Down** keyboard buttons to scroll through the Stages. A specific Stage can be found by using the **Goto** button on the editor dialog. After the comments have been entered, press the **OK** button to save the comments and close the editor.

Editing the Comments

The keyboard shortcut keys can be used to copy, cut and paste comments between stages.

1. Position the cursor at the beginning of the text to be copied or cut.
2. Press and hold the left mouse button and move the cursor to highlight the text, then release the button. The **Shift + Arrow** keys can also be used to highlight the text.
3. Use the **Ctrl + C** keys to copy the text or the **Ctrl + X** keys to cut the text.
4. Locate the stage where the information is to be pasted (Use **Previous**, **Next** or **Goto**).
5. Position the cursor where the text is to be pasted and click the left mouse button, then press **Ctrl + V** to paste the text.
6. The **Delete** key can also be used to delete text.



NOTE: All documentation edits are written to the documentation files when they are entered/edited.

Importing and Exporting

DirectSOFT6 can import and export ladder programs, element documentation (nicknames, wiring info and descriptions) and rung comments from a project. The Import/Export data is expected to be in CSV format (comma-separated variables) which is a popular import/export text format for applications like Microsoft Excel and AutoCAD. For example, Microsoft Excel can be used to generate an element documentation file to be imported directly into a *DirectSOFT6* project. The existing element documentation can be exported to a CSV file that can be used in diagrams in an AutoCAD program.

Exporting Program Documentation

The project must be open in order to export program documentation. Three export options are available to choose from, Program, Element Documentation and Rung Comments. The following steps will show how to export a program. There are two ways to export a program, either select **File > Export > Program** from the Menu bar or select the **Export** button on the File toolbar if it is displayed. Either method used will open the **Export Program** dialog shown on the facing page.

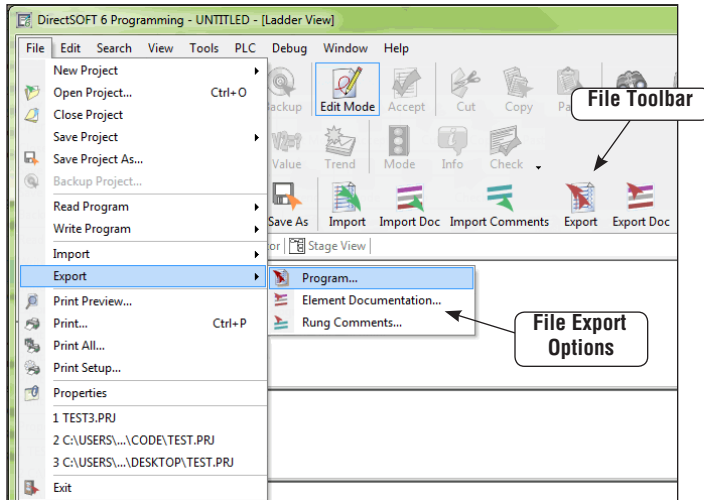

In the Export Program dialog, select where the program is to be exported to, enter the program name and click the **Save** button.

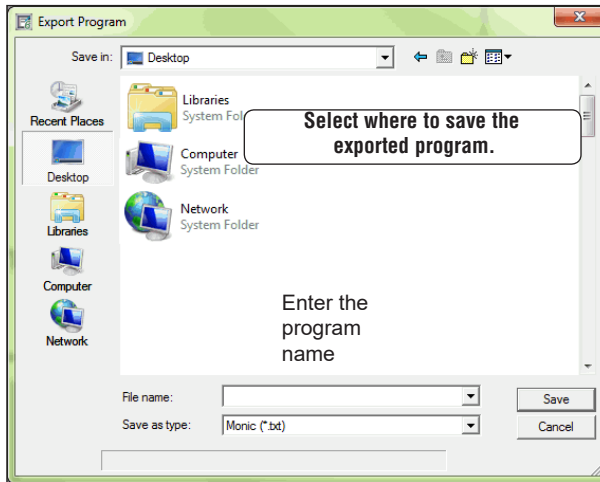

The following dialog will appear so options can be selected and saved. Click the **OK** button to save the program to a text file.

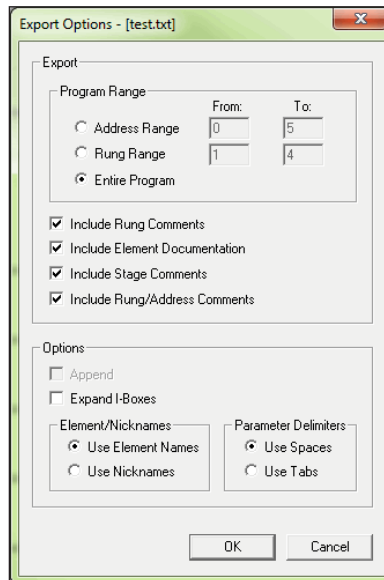

The text file can be opened with Notepad or equivalent word processor. The Notepad example below shows what can be exported. Note the Rung Comments and the Element Documentation.

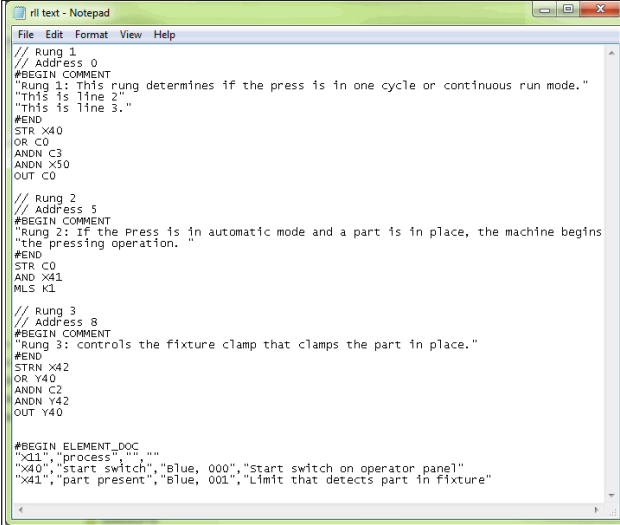

```
File Edit Format View Help
// Rung 1
// Address 0
#BEGIN_COMMENT
"Rung 1: This rung determines if the press is in one cycle or continuous run mode."
"This is line 2."
"This is line 3."
#END
STR X40
OR C0
ANDN C3
ANDN X50
OUT C0

// Rung 2
// Address 5
#BEGIN_COMMENT
"Rung 2: If the Press is in automatic mode and a part is in place, the machine begins
the pressing operation."
#END
STR C0
AND X41
MLS K1

// Rung 3
// Address 8
#BEGIN_COMMENT
"Rung 3: controls the fixture clamp that clamps the part in place."
#END
STRN X42
OR Y40
ANDN C2
ANDN Y42
OUT Y40

#BEGIN_ELEMENT_DOC
"X11", "process", "G", ""
"X40", "start switch", "Blue, 000", "start switch on operator panel"
"X41", "part present", "Blue, 001", "Limit that detects part in fixture"
```

Export Element Documentation

Element information can be exported from a project to a .csv file. The following illustrations will show the steps to use to export the documentation. Press the Export Element Documentation button on the File toolbar or select **File > Export > Element Documentation** to export the documentation.

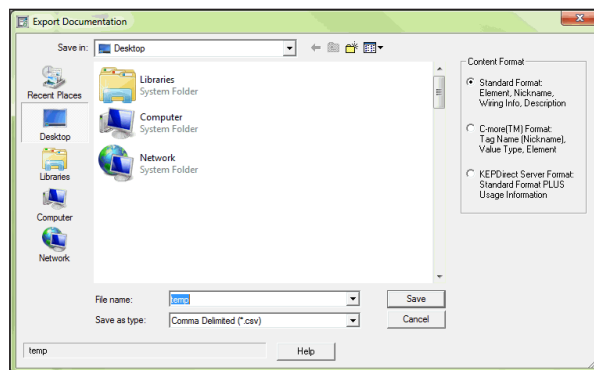

There are three different formats to select from to export. Standard, C-more and KEPDirect Server formats. All formats generate a .csv file in spreadsheet form.

This is a standard format showing an Excel spreadsheet with the element reference in column A, the nickname in column B, wiring information in column C and description in column D.

A1	B	C	D	E	F	G	H	I	J
1	X40	start switc	Blue, 000	Start switch on operator panel					
2	X41	part preser	Blue, 001	Limit that detects part in fixture					
3	X42	part locker	Blue, 002	Confirms that the clamp is locked					
4	X43	part unlock	Blue, 003	Confirms that the clamp is unlocked					
5	X44	lower limit	Blue, 004	Lower arbor limit.					
6	X45	upper limit	Blue, 005	Upper arbor limit					
7	X46	index conv	Blue, 006	Confirms that the conveyor actually moved forward					
8	X47	one cycle	Blue, 007	Switch on operator panel selects one cycle or automatic operation					
9	X50	stop switc	Blue, 008	Stop Switch on operator panel					
10	Y40	clamp	Red, 000	Clamp to hold part in place					
11	Y41	arbor down	Red, 001	Output for downward movement of the arbor					
12	Y42	conveyor	Red, 002	Motor starter for conveyor motor					
13	C0	Automatic mode		Control relay used to signal press is in automatic mode					
14	C1	press complete		Control relay showing that the part has been pressed					
15	C2	release clamp		Control relay that controls the releasing of the fixture clamp					
16	C3	1 cycle mode		Control relay used to signal that press is in one cycle mode					
17	T0	Conveyor delay		Delay timer for conveyor					
18	CT0	Part Counter		Self resetting parts counter to count number of parts made					
19									
20									

The illustration below is the C-more format showing an Excel spreadsheet with the tagname (element) in column C, the data type in column D and element reference (Address) in column G.

A	B	C	D	E	F	G
1	ProtocolID	DeviceName	TagName	DataType	DataCount	Retentive
2	100	DEV001	PUMP NO. 2 START PB	Discrete	1	FALSE
3	100	DEV001	PUMP NO. 1 START PB	Discrete	1	FALSE
4	100	DEV001	PUMP NO. 1 STOP PB	Discrete	1	FALSE
5	100	DEV001	PUMP NO. 2 STOP PB	Discrete	1	FALSE
6	100	DEV001	SOUTH STATION CONTROL OPENED	Discrete	1	FALSE
7	100	DEV001	SOUTH STATION CONTROL CLOSDSED	Discrete	1	FALSE
8	100	DEV001	NORTH STATION CONTROL OPENED	Discrete	1	FALSE
9	100	DEV001	NORTH STATION CONTROL CLOSDSED	Discrete	1	FALSE
10	100	DEV001	PUMP NO. 1 AUTO	Discrete	1	FALSE
11	100	DEV001	PUMP NO. 2 AUTO	Discrete	1	FALSE
12	100	DEV001	PUMP NO. 1 SPEED - RPM	Signed_int_16	1	FALSE
13	100	DEV001	PUMP NO. 2 SPEED - RPM	Signed_int_16	1	FALSE
14	100	DEV001	FLOW RATE - GPM	BCD_int_16	1	FALSE
15						
16						
17						
18						
19						
20						

NOTE: If unassigned nicknames are exported, they will appear in the resultant text as the following types:



UB - unassigned bit

UBY - unassigned byte (useful only for R memory in the DL305)

UW - unassigned word

UDW - unassigned double-word

UU - unassigned unknown (used for uninitialized types, should never be used)

Export Rung Comments

The program rung comments can be exported from a project to a text file and a printout can be obtained using Microsoft Notepad or equivalent word processor. The following dialog will appear when either pressing the **Export Comments** button on the File toolbar if it is displayed or by pressing **File > Export > Rung Comments**. Select where the file is to be saved, then name the text file and press the **Save** button.

The illustration below is an example of an exported comment text file shown with Microsoft Notepad.

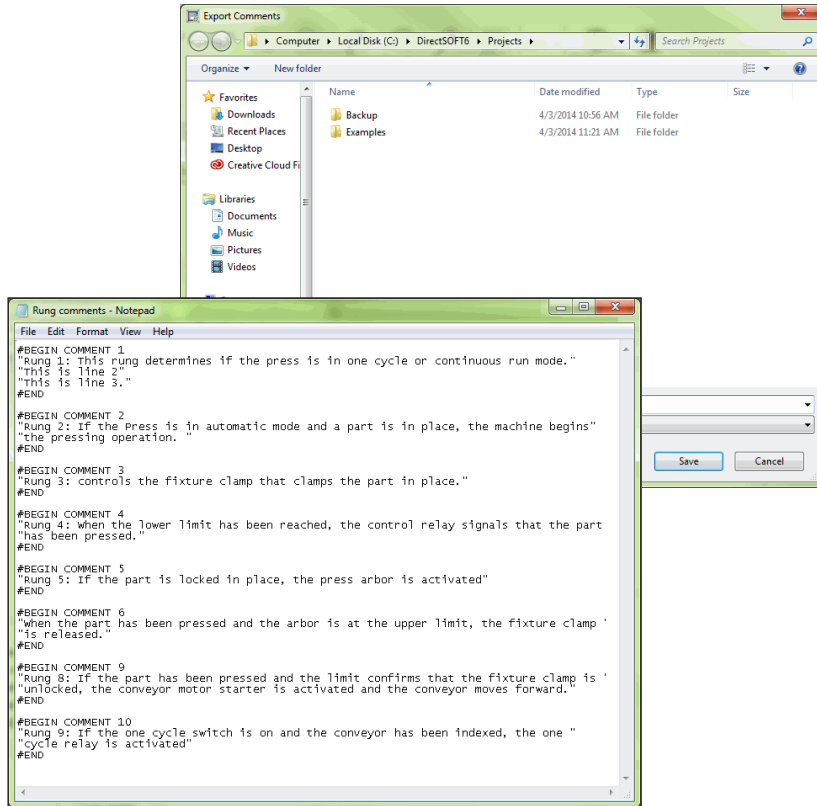

Importing a Program

There may be a time when it is necessary to import a *DirectSOFT6* program which has been previously edited and exported as a text file. This could be an entire program or just a few rungs with element nicknames and comments. Use the following illustrated steps to guide you through the import procedure.

Begin by opening the New Project dialog from the *DirectSOFT6* Launch window (page 3-4). Cancel the New Project dialog, then either select **File > Import > Program** or press the **Import** button on the File toolbar if it is displayed.

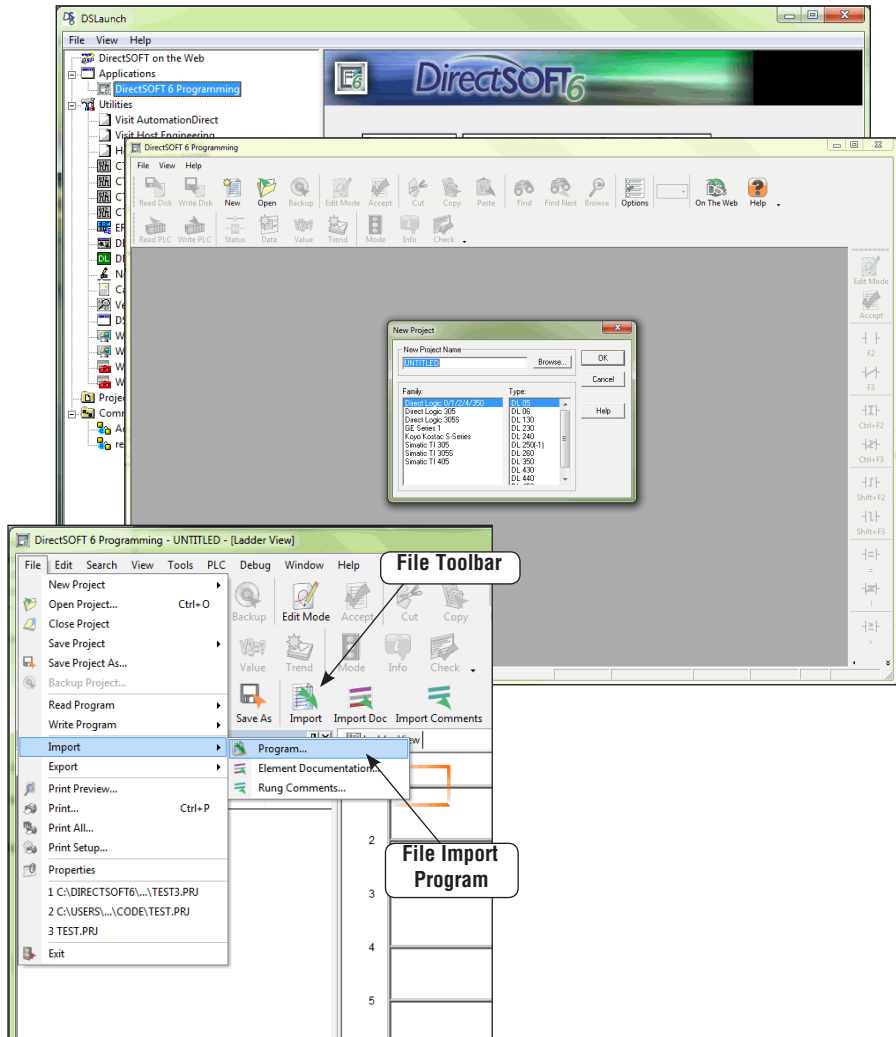

The **Import Program** dialog will appear so the program text to be imported can be selected. Select a previously exported *DirectSOFT6* program to import. Choose the program text file and click **Open**.

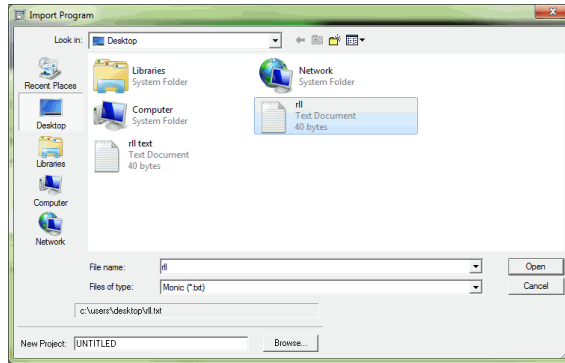

The complete imported program will appear as shown below. In this example, all elements, element descriptions, nicknames and rung comments appear in the program along with the cross reference.

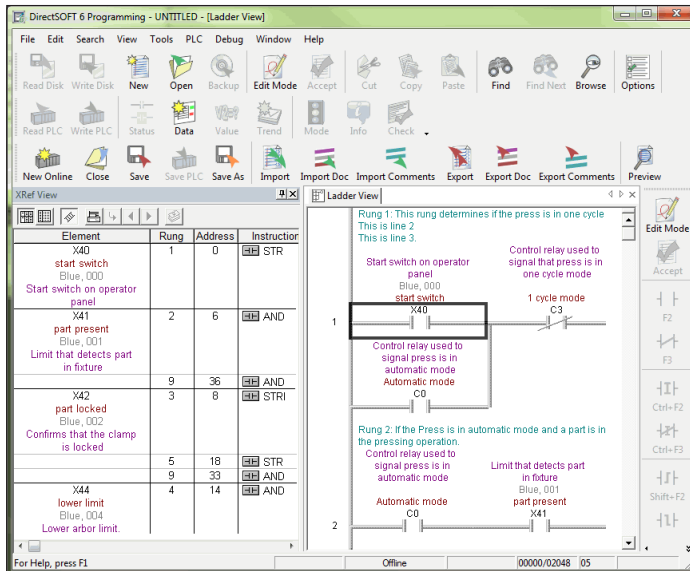

Element	Rung	Address	Instruction
Y40 start switch Blue, 000 Start switch on operator panel	1	0	STR
Y41 part present Blue, 001 Limit that detects part in fixture	2	6	AND
Y42 part locked Blue, 002 Confirms that the clamp is locked	9	36	AND
Y44 lower limit Blue, 004 Lower arbor limit.	4	14	AND
	5	19	STR
	9	33	AND

Rung 1: This rung determines if the press is in one cycle
This is line 2
This is line 3.
Start switch on operator panel Blue, 000 start switch
Control relay used to signal that press is in one cycle mode
1 cycle mode C3
Control relay used to signal press is in automatic mode
Automatic mode C0

Rung 2: If the Press is in automatic mode and a part is in the pressing operation.
Control relay used to signal press is in automatic mode
Automatic mode C0
Limit that detects part in fixture Blue, 001 part present Y41

Exported programs, element documentation and rung comments can be imported using the *DirectSOFT6* programming window if it has been opened to edit another program. This is done by first saving and closing the current program. Next, either select **File > Import > Program** or press the **Import** button on the File toolbar. The program to be imported is selected and opened as shown in the previous example.

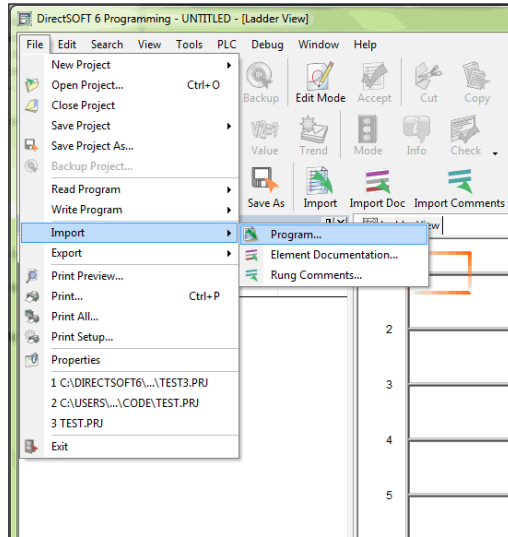

Importing Element Documentation

To import program documentation, a project must be open. This project can be the one currently open. The typical method for importing element documentation is to import a .csv file which has been previously exported. It is possible to generate element documentation using a spreadsheet such as Microsoft Excel, but it is important to follow the correct import format. The standard format is in spreadsheet form which should be setup in columns similar to the example below: element reference in column A, the nickname in column B, wiring information in column C and element descriptions in column D.

	A	B	C	D	E	F	G	H	I	J	K
1	X40	start switc	Blue, 000	Start switch on operator panel							
2	X41	part preset	Blue, 001	Limit that detects part in fixture							
3	X42	part locker	Blue, 002	Confirms that the clamp is locked							
4	X43	part unlock	Blue, 003	Confirms that the clamp is unlocked							
5	X44	lower limit	Blue, 004	Lower arbor limit.							
6	X45	upper limit	Blue, 005	Upper arbor limit							
7	X46	index conv	Blue, 006	Confirms that the conveyor actually moved forward							
8	X47	one cycle	Blue, 007	Switch on operator panel selects one cycle or automatic operation							
9	X50	stop switc	Blue, 008	Stop Switch on operator panel							
10	Y40	clamp	Red, 000	Clamp to hold part in place							
11	Y41	arbor down	Red, 001	Output for downward movement of the arbor							
12	Y42	conveyor	Red, 002	Motor starter for conveyor motor							
13	C0	Automatic mode		Control relay used to signal press is in automatic mode							
14	C1	press complete		Control relay showing that the part has been pressed							
15	C2	release clamp		Control relay that controls the releasing of the fixture clamp							
16	C3	1 cycle mode		Control relay used to signal that press is in one cycle mode							
17	T0	Conveyor delay		Delay timer for conveyor							
18	CT0	Part Counter		Self resetting parts counter to count number of parts made							
19											

To import element documentation, select **File > Import > Element Documentation** or press the **Import Doc** button on the File toolbar. The window shown here will appear. Select the folder and the .csv file to be imported. Notice the **Import Method** box located on the right side of the window.

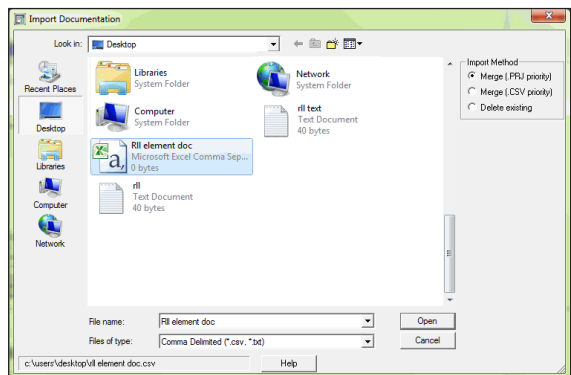

There are three import methods to select: **Merge (.PRJ priority)**, **Merge (.CSV priority)** and **Delete existing**. Selecting one of the three methods will determine the course of action which will be taken if the currently open project and the imported file have duplicate nicknames.

- If **.PRJ priority** is selected, the nicknames in the imported file will be added to the project file. If there are duplicates, the nickname in the project file will be kept.
- If **.CSV priority** is selected, the nicknames will be added to the project file. If there are duplicate nicknames, the import file will overwrite the ones in the project file.
- If **Delete existing** is selected, all of the element documentation of the open project will be deleted, then it will be rebuilt with the contents of the .csv file.
- Press the **Open** button to execute the import.

NOTE: If the following element types are imported, they will appear in the **DirectSOFT6** documentation editor with “___” under the element type column:



UB - unassigned bit

UBY - unassigned byte (useful only for R memory in the DL305)

UW - unassigned word

UDW - unassigned double-word

UU - unassigned unknown (used for uninitialized types, should never be used)

Once the element documentation is imported, the Documentation editor will be updated with the imported information. This can be verified by opening the Documentation editor from Tools on the Menu bar, the Documentation Editor button on the Tools toolbar if it is displayed or use **Ctrl + D**. When the elements are created or if they are already used in the program, the element will be updated with the new information.

Importing Program Comments

Exported program comments are imported like the element documentation as described on the previous two pages. To do this, select **File > Import > Rung Comments** on the Menu bar or press the **Import Comments** button on the File toolbar. The following window will appear. Select the folder and the .txt file to be imported.

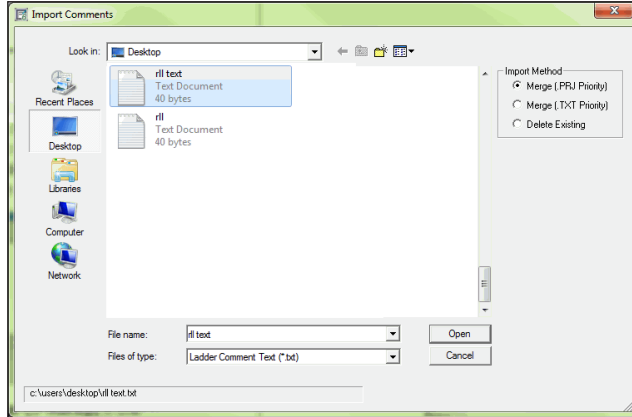

Also select the **Import Method** to use. **Merge (.PRJ priority)** if the current project is to remain in place when the import is executed. If comment matching occurs, a message will appear asking which one to update, the imported file or the existing file. Selecting **Merge (.TXT priority)** will allow the imported comments to overwrite the existing ones. **Delete Existing** will delete the current comments and update with the imported comments.

Insert Instructions

The Insert Instructions From File feature will allow the insertion of mnemonic text files as instructions within an open project. Mnemonic instructions can be inserted one time or several times within a program. To use this feature, there must be an existing text file, such as, a file written with MS Notepad. This file must be written in mnemonic text form like the example on left. Note that rung comments, element descriptions, element nicknames and wiring information can be edited within the text file to be inserted.

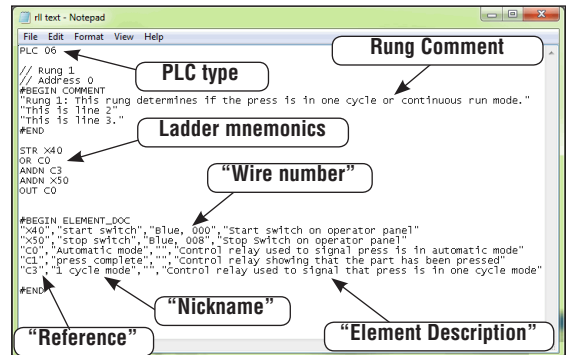

The text file needs to be edited in the same format as shown, with a PLC type at the beginning, #BEGIN, the documentation and #END. Quotation marks are placed around each line of rung comments. Of course, the ladder mnemonics are also edited with the text file. The element documentation must be in this form: “element reference”, “element nickname”, “wire number”, “description”. Quotation marks must be used with each entry followed by a comma. If an entry is to be left blank, the quotation marks *must not be omitted*.

The mnemonics text which is to be inserted can also be edited without comments like the example below. Note the PLC type is at the beginning of the text.

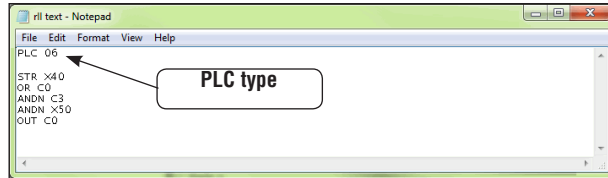

To insert the mnemonic text in a program being edited (Edit Mode), either use the **Tools > Insert Instructions From File** on the Menu bar or press the **Insert Instructions** button on the Tools menu if it is displayed.

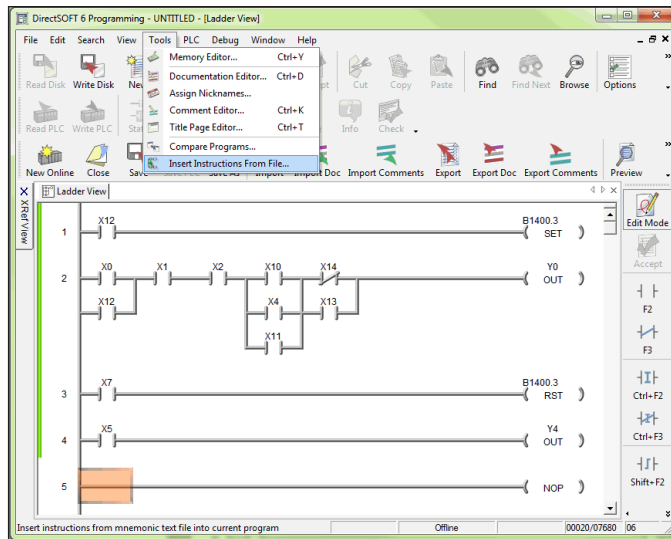

The **Insert Instructions** dialog will appear. Select the folder where the text file is located, then select the text file to be inserted. Next, choose either **Insert at Beginning**, **End** or **Before Rung Number**. How the element documentation can be imported involving “collisions” with existing program documentation can also be chosen. Select **Merge (.PRJ Priority)** if the existing project documentation is to remain unchanged. Select **Merge (.TXT Priority)** if the new documentation is to overwrite the existing documentation in the program. If the program element documentation is not to be changed, select **Ignore Element Documentation**. Press the **Open** button to execute the instruction.

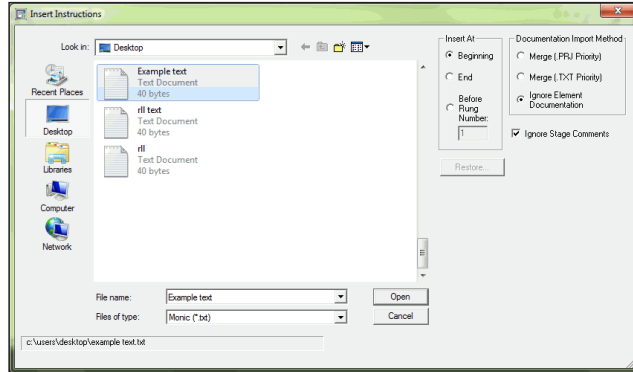

The **DirectSOFT6** Ladder view now displays the inserted instructions and documentation.

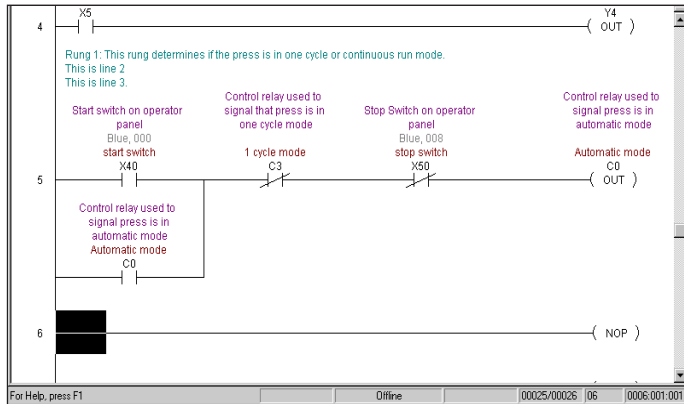

Restore

One option which the Insert Instructions function has that can be useful is the **Restore** feature. Each time the Insert Instructions is executed, a backup copy of the entire program is made before the insert occurs. If an error is made, i.e. wrong code, just press the **Restore** button and the program will be restored to its original state.

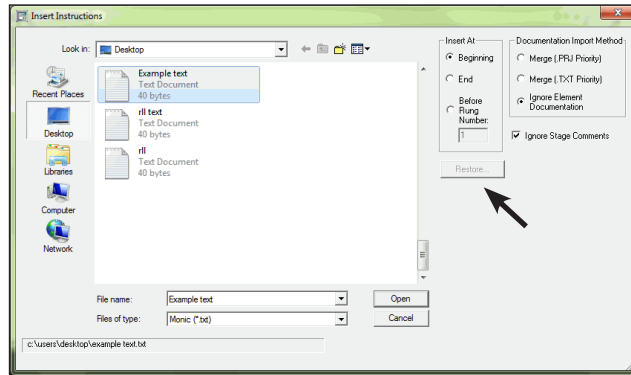

Prevent Documentation Loss

The documentation which is created with *DirectSOFT6* is stored on disk. Each time a project is opened with *DirectSOFT6*, there are multiple project files opened. Apply the same precautions to your project as you would with any other database package to avoid data loss.

Backing up the project files is the best insurance to prevent loss. Any time changes are made to a project, make a copy of the project before starting. If something goes wrong, the original will remain intact and unchanged. There are four different methods to preserve a project as a program is created and after the project has been completed. The four methods are: Save Project (to disk), Save Project As, Backup Project and Export Program.

Save Project

Save Project to Disk should be used to save your project often. Your entire project, i.e., program and all documentation will be saved to the drive that is being worked from, usually the C: drive. From the Menu bar, select **File > Save Project > to Disk** or press **Ctrl + S** (keyboard shortcut).

To save a project to a different folder than the one being worked from, select **File > Save Project As** from the Menu bar. The save as window will appear so the folder can be selected where the project is to be saved. Name the project, press the **Save** button and the entire project will be saved.

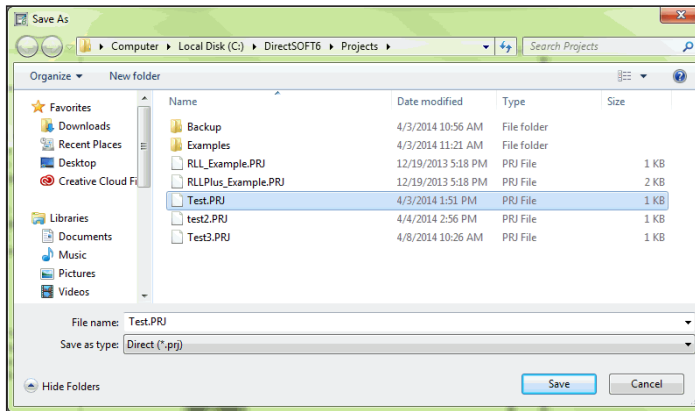

NOTE: The *Write to Disk* button on the *Offline* toolbar only saves the ladder logic program.



Backup Project

The backup feature is another way to save your project. Selecting **File > Backup Project** on the Menu bar or pressing the **Backup** button on the Offline toolbar will open the following dialog asking if the project is to be saved. Press the **OK** button to save the project.

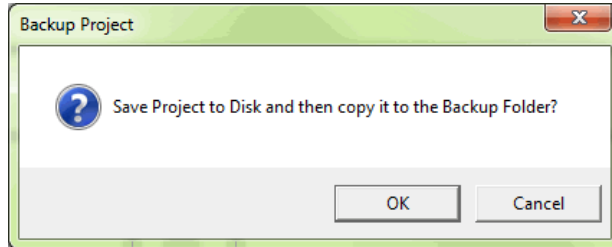

The following **Backup Project** dialog will appear, the project can be saved with the default date/time stamp or rename the folder. A different drive can also be selected to save the project.

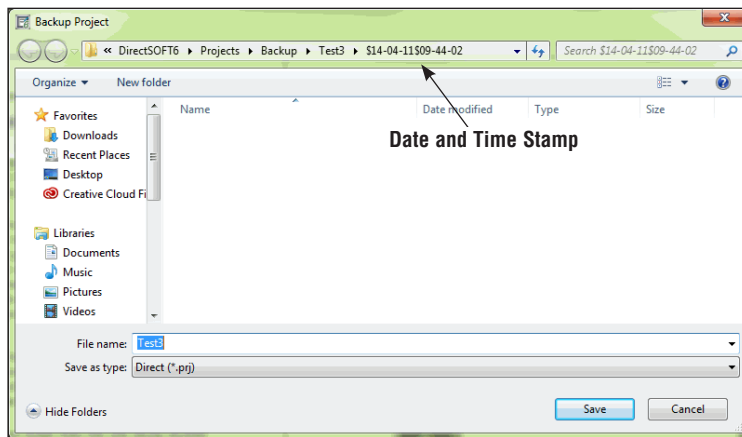

The last backup method is to use the export program feature as explained previously. This method will save a program to a text file. One advantage of the text file is that the program or comments can be edited without using *DirectSOFT6*.

Close all other applications that may be running to allow as much free RAM as possible. This not only lessens chances of memory conflicts, but also allows *DirectSOFT6* to run much faster.

Consider printing a hard copy of the program at longer intervals. If your computer breaks down or you lose all of the data due to a disk crash, you will at least have a hard copy of the program.