

SPECIFICATIONS



In This Chapter...

| | |
|---|-------------|
| Available Models | 2-4 |
| Model Specifications | 2-5 |
| Specifications common to all models | 2-6 |
| 6-inch Models | 2-7 |
| 7-inch Models | 2-8 |
| 8-inch and 10-inch Models | 2-9 |
| 12-inch and 15-inch Models | 2-10 |
| EA9-T6CL-R, EA9-T6CL | 2-11 |
| Dimensions, Inches [mm]..... | 2-11 |
| Ports and Memory Expansion..... | 2-12 |
| EA9-T7CL-R, EA9-T7CL | 2-13 |
| Dimensions, Inches [mm]..... | 2-13 |
| Ports and Memory Expansion..... | 2-14 |
| EA9-T8CL | 2-15 |
| Dimensions, Inches [mm]..... | 2-15 |
| Ports and Memory Expansion..... | 2-16 |
| EA9-T10CL | 2-17 |
| Dimensions, Inches [mm]..... | 2-17 |
| EA9-T10WCL | 2-18 |
| Dimensions, Inches [mm]..... | 2-18 |
| Ports and Memory Expansion..... | 2-19 |

SPECIFICATIONS



CHAPTER 2

| | |
|---|-------------|
| EA9-T12CL | 2-20 |
| Dimensions, Inches [mm]..... | 2-20 |
| Ports and Memory Expansion..... | 2-21 |
| EA9-T15CL-R, EA9-T15CL | 2-22 |
| Dimensions, Inches [mm]..... | 2-22 |
| Ports and Memory Expansion..... | 2-23 |
| Mounting Clearances | 2-25 |
| EA9-T15CL-R, EA9-T15CL Derating | 2-26 |
| Communications Ports | 2-27 |
| Handling External Memory Devices | 2-30 |
| Writing to External Memory Devices | 2-30 |
| Memory Device Formatting..... | 2-30 |
| Minimizing Data Errors..... | 2-31 |
| Monitoring Available Memory | 2-31 |
| File Name Limitations..... | 2-32 |
| Power Loss Retention | 2-32 |
| Chemical Compatibility | 2-32 |

This page intentionally left blank

Available Models

The *C-more*[®] Operator Interface is the next generation of touch panel brought to you by AutomationDirect. It has been designed to display and interchange graphical data from a PLC by merely viewing or touching the screen.

The *C-more* Touch Panel is available in a variety of models to suit your application. Refer to the following tables for a list of part numbers, descriptions and options available.

| Part Number | Description | Project Memory | SD Card Option | USB Device | Ethernet | HDMI Video Out |
|-------------|---|----------------|----------------|------------|----------|----------------|
| EA9-T6CL-R | <i>C-more</i> EA9 series touch screen HMI, 6in color TFT LCD, 320 x 240 pixel, QVGA, LED backlight, supports (1) serial and (2) USB ports and (1) memory card slot. | 26 MB | 1 slot | Yes | No | No |
| EA9-T6CL | <i>C-more</i> EA9 series touch screen HMI, 6in color TFT LCD, 320 x 240 pixel, QVGA, LED backlight, supports (3) serial, (1) Ethernet and (2) USB ports, (1) memory card slot and (1) audio line out. | 26 MB | 1 slot | Yes | Yes | No |
| EA9-T7CL-R | <i>C-more</i> EA9 series touch screen HMI, 7in color TFT LCD, widescreen, 800 x 480 pixel, WVGA, LED backlight, supports (1) serial, (1) Ethernet and (2) USB ports and (1) memory card slot. | 43 MB | 1 slot | Yes | Yes | No |
| EA9-T7CL | <i>C-more</i> EA9 series touch screen HMI, 7in color TFT LCD, widescreen, 800 x 480 pixel, WVGA, LED backlight, supports (3) serial, (1) Ethernet and (2) USB ports, (1) memory card slot and (1) audio line out. | 43 MB | 1 slot | Yes | Yes | No |
| EA9-T8CL | <i>C-more</i> EA9 series touch screen HMI, 8in color TFT LCD, 800 x 600 pixel, SVGA, LED backlight, supports (3) serial, (1) Ethernet and (2) USB ports, (1) memory card slot and (1) audio line out. | 43 MB | 1 slot | Yes | Yes | No |
| EA9-T10CL | <i>C-more</i> EA9 series touch screen HMI, 10in color TFT LCD, 800 x 600 pixel, SVGA, LED backlight, supports (3) serial, (1) Ethernet and (2) USB ports, (1) memory card slot and (1) audio line out. | 43 MB | 1 slot | Yes | Yes | No |
| EA9-T10WCL | <i>C-more</i> EA9 series touch screen HMI, 10in color TFT LCD, widescreen, 1024 x 600 pixel, WSVGA, LED backlight, supports (3) serial, (1) Ethernet and (2) USB ports, (1) memory card slot and (1) audio line out. | 43 MB | 1 slot | Yes | Yes | No |
| EA9-T12CL | <i>C-more</i> EA9 series touch screen HMI, 12in color TFT LCD, 800 x 600 pixel, SVGA, LED backlight, supports (3) serial, (1) Ethernet and (2) USB ports, (2) memory card slots, (1) HDMI video out and (1) audio line out. | 43 MB | 2 slots | Yes | Yes | Yes |
| EA9-T15CL-R | <i>C-more</i> EA9 series touch screen HMI, 15in color TFT LCD, 1024 x 768 pixel, XGA, LED backlight, supports (1) serial, (1) Ethernet port and (2) USB ports and (2) memory card slots. | 43 MB | 2 slots | Yes | Yes | No |
| EA9-T15CL | <i>C-more</i> EA9 series touch screen HMI, 15in color TFT LCD, 1024 x 768 pixel, XGA, LED backlight, supports (3) serial, (1) Ethernet and (2) USB ports, (2) memory card slots, (1) HDMI video out and (1) audio line out. | 43 MB | 2 slots | Yes | Yes | Yes |

Model Specifications

The following specification tables are separated into these groups:

- Specifications common to all models
- 6" & 7" Reduced and Full Feature Models, EA9-T6CL-R, EA9-T6CL, EA9-T7CL-R and EA9-T7CL
- 8" & 10" Full Feature Models, EA9-T8CL, EA9-T10CL and EA9-T10WCL
- 12" & 15" Reduced and Full Feature Models, EA9-T12CL, EA9-T15CL-R and EA9-T15CL

Specification tables begin on the next page.

Specifications common to all models

| Specification | Model | All Models |
|------------------------------------|-------|---|
| Operating Temperature | | 0 to 50 °C (32 to 122 °F); Maximum surrounding air temperature rating: 50 °C (122 °F) IEC 60068-2-14 (Test Nb, Thermal Shock) |
| Altitude | | Up to 2000m (6562 ft) |
| Storage Temperature | | -20 to +60 °C (-4 to +140 °F) IEC 60068-2-1 (Test Ab, Cold) IEC 60068-2-2 (Test Bb, Dry Heat) IEC 60068-2-14 (Test Na, Thermal Shock) |
| Humidity | | 5–95% RH (non-condensing) |
| Environment | | For use in Pollution Degree 2 environment, no corrosive gases permitted |
| Noise Immunity | | (EN61131-2) EN61000-4-2 (ESD), EN61000-4-3 (RFI) EN61000-4-4 (FTB) EN61000-4-5 (Serge) EN61000-4-6 (Conducted) EN61000-4-8 (Power frequency magnetic field immunity) (Local Test) RFI, (145MHz, 440Mhz 10W @ 10cm) Impulse 1000V @ 1µs pulse |
| Withstand Voltage | | 1000 VAC, 1 min. (FG to Power supply) |
| Insulation Resistance | | > 10M ohm @ 500V DC (FG to Power supply) |
| Vibration | | IEC60068-2-6 (Test Fc) |
| Shock | | IEC60068-2-27 (Test Ea) |
| Emission | | EN55011 Class A (Radiated RF emission) |
| Enclosure | | NEMA 250 type 4/4X indoor use only UL50 type 4X indoor use only IP-65 indoor use only (When mounted correctly) |
| Backlight Average Lifetime* | | 50,000 hours @ 25 °C |
| Touch Panel Type** | | Four-wire analog resistive |
| Supply Power | | 10.2-26.4VDC Class2 or SELV (Safety Extra-Low Voltage) Circuit or Limited Energy Circuit (LEC) or use the AC/DC Power Adapter, EA-AC, to power the touch panel from a 100-240 VAC, 50/60 Hz power source. Reverse Polarity Protected |



*** NOTE:** The backlight average lifetime is defined as the average usage time it takes before the brightness becomes 50% of the initial brightness. The lifetime of the backlight depends on the ambient temperature. The lifetime will decrease under low or high temperature usage.



**** NOTE:** The Touchscreen is designed to respond to a single touch. If it is touched at multiple points at the same time, an unexpected object may be activated.

6-inch Models

| Specification | Model | 6" TFT color w/ base features | 6" TFT color w/ full features |
|------------------------------------|-------|---|---|
| Part Number | | EA9-T6CL-R | EA9-T6CL |
| Display Actual Size and Type | | 5.7" TFT color | |
| Display Viewing Area | | 4.54" x 3.40" [115.2 mm x 86.4 mm] | |
| Weight | | 1.56 lb (710g) | 1.59 lb (720g) |
| Screen Pixel | | 320 x 240 (QVGA) | |
| Display Brightness | | 280 nits (typ) | |
| LCD Panel Dot Pitch | | 0.18 mm x 0.18 mm | |
| Color Scale | | 65,536 | |
| Project Memory | | 26 MB | |
| Number of Screens | | Up to 999 screens – limited by project memory | |
| Realtime Clock | | Realtime Clock Built into panel, backed up for 30 days at 25°C after power has been applied for 24 hours | |
| Calendar - Month / Day / Year | | Yes - monthly deviation 60 sec at 25°C | |
| Serial Port 1 | | 15-pin D-sub female - RS2342C, RS-422/485 | |
| Serial Port 2 | | N/A | 3-wire terminal block - RS-485 |
| Serial Port 3 | | N/A | RJ-12 modular jack - RS-232C |
| USB Port - Type B | | USB 2.0 High speed (480 Mbps) Type B - Download/Program Max cable length - 15 ft. | |
| USB Port - Type A | | USB 2.0 High speed (480 Mbps) Type A - for USB device options Max cable length - 15ft Bus Power – Less than 200mA at 5VDC | |
| Ethernet Port | | N/A | Ethernet Port Ethernet 10/100 Base-T, auto MDI/ MDI-X |
| Audio Line Out | | N/A | 3.5 mm mini jack: 3-pin – requires amplifier and speaker(s), Full Scale Output: 1.0 Vrms |
| Mic In (future) | | N/A | 3.5 mm mini jack: 2pin, Input: 100 mVrms, Impedance: <10kOhms |
| SD Card Slot | | 1 slot. Supports max 2 GB (SD), max 32 GB (SDHC) | |
| HDMI Video Out | | N/A | |
| Power Consumption | | 16.0W 1.30A @ 12 VDC 0.66A @ 24 VDC | |
| Internal Fuse (non-replaceable) | | 4A | |
| Agency Approvals | | UL61010 (E157382), CE (EN61131-2) Class 1, Div 2, Groups A, B, C, CUL Canadian C22.2, RoHS (2011/65/EU) | |

7-inch Models

| Specification | Model | 7" TFT color w/ base features | 7" TFT color w/ full features |
|------------------------------------|-------|---|--|
| Part Number | | EA9-T7CL-R | EA9-T7CL |
| Display Actual Size and Type | | 7.0" TFT color | |
| Display Viewing Area | | 6.0" x 3.60" [152.4 mm x 91.4 mm] | |
| Weight | | 1.46 lb (660g) | 1.48 lb (670g) |
| Screen Pixel | | 800 x 480 (WVGA) | |
| Display Brightness | | 350 nits (typ) | |
| LCD Panel Dot Pitch | | 0.19 mm x 0.19 mm | |
| Color Scale | | 65,536 | |
| Project Memory | | 43 MB | |
| Number of Screens | | Up to 999 screens – limited by project memory | |
| Realtime Clock | | Realtime Clock Built into panel, backed up for 30 days at 25°C after power has been applied for 24 hours | |
| Calendar - Month / Day / Year | | Yes - monthly deviation 60 sec at 25°C | |
| Serial Port 1 | | 15-pin D-sub female - RS2342C, RS-422/485 | |
| Serial Port 2 | | N/A | 3-wire terminal block - RS-485 |
| Serial Port 3 | | N/A | RJ-12 modular jack - RS-232C |
| USB Port - Type B | | USB 2.0 High speed (480 Mbps) Type B - Download/Program Max cable length - 15 ft. | |
| USB Port - Type A | | USB 2.0 High speed (480 Mbps) Type A - for USB device options Max cable length - 15ft Bus Power – Less than 200mA at 5VDC | |
| Ethernet Port | | Ethernet Port Ethernet 10/100 Base-T, auto MDI/MDI-X | |
| Audio Line Out | | N/A | 3.5 mm mini jack: 3-pin – requires amplifier and speaker(s), Full Scale Output: 1.0 Vrms |
| Mic In (future) | | N/A | 3.5 mm mini jack: 2pin, Input: 100 mVrms, Impedance: <10kOhms |
| SD Card Slot | | 1 slot. Supports max 2 GB (SD,) max 32 GB (SDHC) | |
| HDMI Video Out | | N/A | |
| Power Consumption | | 16.0W 1.30A @ 12 VDC 0.66A @ 24 VDC | |
| Internal Fuse (non-replaceable) | | 4A | |
| Agency Approvals | | UL61010 (E157382), CE (EN61131-2), CUL Canadian C22.2, RoHS (2011/65/EU) | |

8-inch and 10-inch Models

| Specification | Model | 8" TFT color w/ full features | 10" TFT color w/ full features | 10" TFT color widescreen w/ full features |
|------------------------------------|-------|---|--|--|
| Part Number | | EA9-T8CL | EA9-T10CL | EA9-T10WCL |
| Display Actual Size and Type | | 8.4" TFT color | 10.4" TFT color | 10.1" TFT color wide |
| Display Viewing Area | | 6.71" x 5.03" [170.4 mm x 127.8mm] | 8.31" x 6.24" [211.2 mm x 158.4 mm] | 8.769" x 4.932" [222.72 mm x 125.28 mm] |
| Weight | | 2.93 lb (1330g) | 4.19 lb (1900g) | 2.43 lb (1100g) |
| Screen Pixel | | 800 x 600 (SVGA) | | 1024 x 600 (WSVGA) |
| Display Brightness | | 310 nits (typ) | 280 nits (typ) | 240 nits (typ) |
| LCD Panel Dot Pitch | | 0.213 mm x 0.213 mm | 0.264 mm x 0.264 mm | 0.218 mm x 0.209 mm |
| Color Scale | | 65,536 colors | | |
| Project Memory | | 43 MB | | |
| Number of Screens | | Up to 999 screens – limited by project memory | | |
| Realtime Clock | | Realtime Clock Built into panel, backed up for 30 days at 25°C | | |
| Calendar - Month / Day / Year | | Yes - monthly deviation 60 sec (Reference) | | |
| Serial Port 1 | | 15-pin D-sub female - RS2342C, RS-422/485 | | |
| Serial Port 2 | | 3-wire terminal block - RS-485 | | |
| Serial Port 3 | | RJ-12 modular jack - RS-232C | | |
| USB Port - Type B | | USB 2.0 High speed (480 Mbps) Type B - Download/Program Max cable length - 15 ft. | | |
| USB Port - Type A | | USB 2.0 High speed (480 Mbps) Type A - for USB device options Max cable length - 15ft Bus Power – Less than 200mA at 5VDC | | |
| Ethernet Port | | Ethernet Port Ethernet 10/100 Base-T, auto MDI/MDI-X | | |
| Audio Line Out | | 3.5 mm mini jack – requires amplifier and speaker(s) | | |
| Mic In (future) | | 3.5 mm mini jack | | |
| SD Card Slot | | 1 slot. Supports max 2 GB (SD,) max 32 GB (SDHC) | | |
| HDMI Video Out | | N/A | | |
| Power Consumption | | 18.0W 1.50A @ 12 VDC 0.75A @ 24 VDC | | 17.0W 1.42A @ 12 VDC 0.71A @ 24 VDC |
| Internal Fuse (non-replaceable) | | 6.3A | | |
| Agency Approvals | | UL508 (E157382), CE (EN61131-2), CUL Canadian C22.2, RoHS (2011/65/EU) | | |

12-inch and 15-inch Models

2

| Specification | Model | 12" TFT color w/ full features | 15" TFT color w/ base features | 15" TFT color w/ full features |
|------------------------------------|-------|---|---|---|
| Part Number | | EA9-T12CL | EA9-T15CL-R | EA9-T15CL |
| Display Actual Size and Type | | 12.1" TFT color | 15.0" TFT color | |
| Display Viewing Area | | 9.69" x 7.26" [246.0 mm x 184.5 mm] | 11.97" x 8.98" [304.1 mm x 228.0 mm] | |
| Weight | | 4.85 lb (2200g) | 6.46 lb (2930g) | 6.50 lb (2950g) |
| Screen Pixel | | 800 x 600 (SVGA) | 1024 x 768 (XGA) | |
| Display Brightness | | 280 nits (typ) | | |
| LCD Panel Dot Pitch | | 0.3075 mm x 0.3075 mm | 0.297 mm x 0.297 mm | |
| Color Scale | | 65,536 colors | | |
| Project Memory | | 43 MB | | |
| Number of Screens | | Up to 999 screens – limited by project memory | | |
| Realtime Clock | | Realtime Clock Built into panel, backed up for 30 days at 25°C | | |
| Calendar - Month / Day / Year | | Yes - monthly deviation 60 sec (Reference) | | |
| Serial PLC Interface Port 1 | | 15-pin D-sub female - RS2342C, RS-422/485 | | |
| Serial PLC Interface Port 2 | | 3-wire terminal block - RS-485 | N/A | 3-wire terminal block - RS-485 |
| Serial PLC Interface Port 3 | | RJ-12 modular jack - RS-232C | N/A | RJ-12 modular jack - RS-232C |
| USB Port - Type B | | USB 2.0 High speed (480 Mbps) Type B - Download/Program Max cable length - 15 ft. | | |
| USB Port - Type A | | USB 2.0 High speed (480 Mbps) Type A - for USB device options Max cable length - 15ft Bus Power – Less than 200mA at 5VDC | | |
| Ethernet Port | | Ethernet Port Ethernet 10/100 Base-T, auto MDI/MDI-X | | |
| Audio Line Out | | 3.5 mm mini jack – requires amplifier and speaker(s) | N/A | 3.5 mm mini jack – requires amplifier and speaker(s) |
| Mic In (future) | | 3.5 mm mini jack | N/A | 3.5 mm mini jack |
| SD Card Slot | | 2 slots. Supports max 2 GB (SD), max 32 GB (SDHC) | | |
| HDMI Video Out | | HDMI Type A Port | N/A | HDMI Type A Port |
| HDMI Supported Resolution | | 800 x 600 (SVGA) | N/A | 1024 x 768 (XGA) |
| Power Consumption | | 21.0W 1.75A @ 12 VDC 0.88A @ 24 VDC | 29.0W 2.40A @ 12 VDC 1.20A @ 24 VDC | |
| Internal Fuse (non-replaceable) | | 6.3A | | |
| Agency Approvals | | UL508 (E157382), CE (EN61131-2), CUL Canadian C22.2, RoHS (2011/65/EU) | | |

EA9-T6CL-R, EA9-T6CL

Dimensions, Inches [mm]

All the necessary mounting hardware is provided with the touch panel. Use the four mounting clips and screws to secure the touch panel to the cabinet or enclosure surface.

A template for marking the cutout dimensions on the mounting surface is provided in the box.

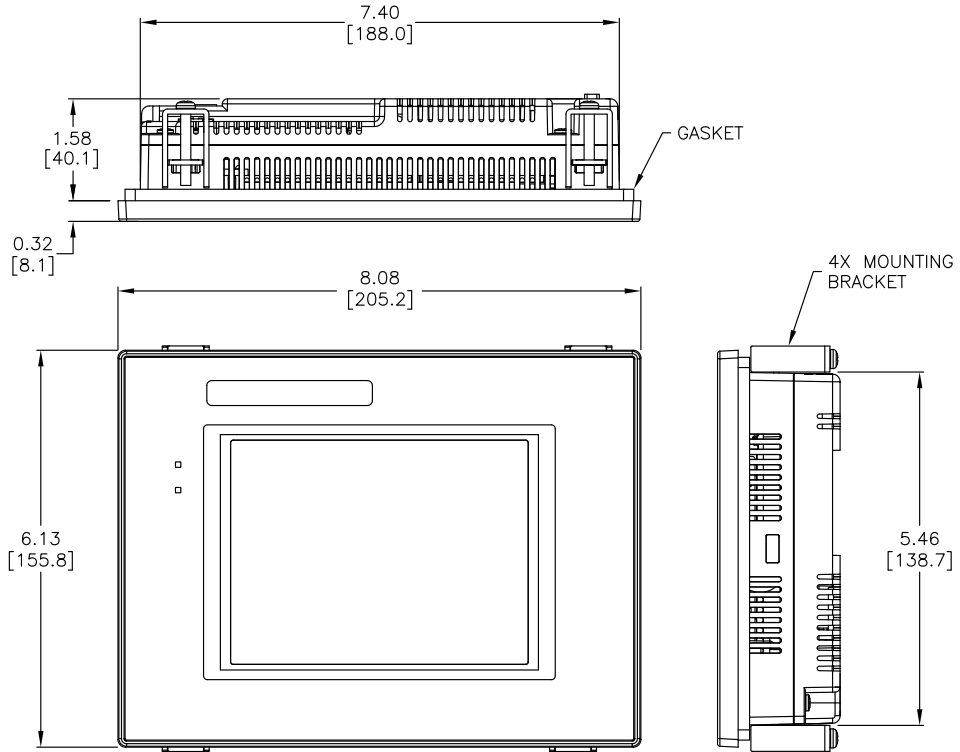

Enclosure Mounting Thickness Ranges and Mounting Clip Screw Torque

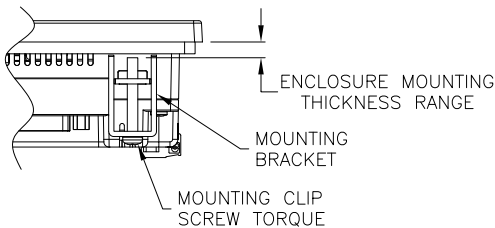

| Touch Panel Size | Enclosure Thickness Range | Mounting Clip Screw Torque | Material |
|--------------------------|---------------------------------|------------------------------------|----------|
| 6", 7", 8", 10" & 12" | 0.039 - 0.20 inch [1 - 5 mm] | 63 - 77 oz-in [0.45 - 0.55 Nm] | Metal |
| 10" Wide, 15" | 0.039 - 0.20 inch [1 - 5 mm] | 92 - 106 oz-in [0.65 - 0.75 Nm] | Metal |

Ports and Memory Expansion

EA9-T6CL-R

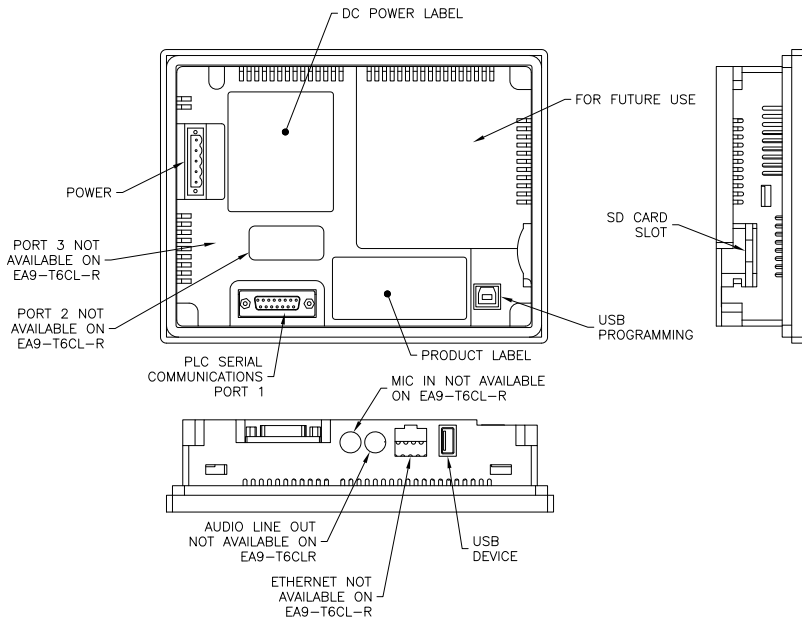

EA9-T6CL

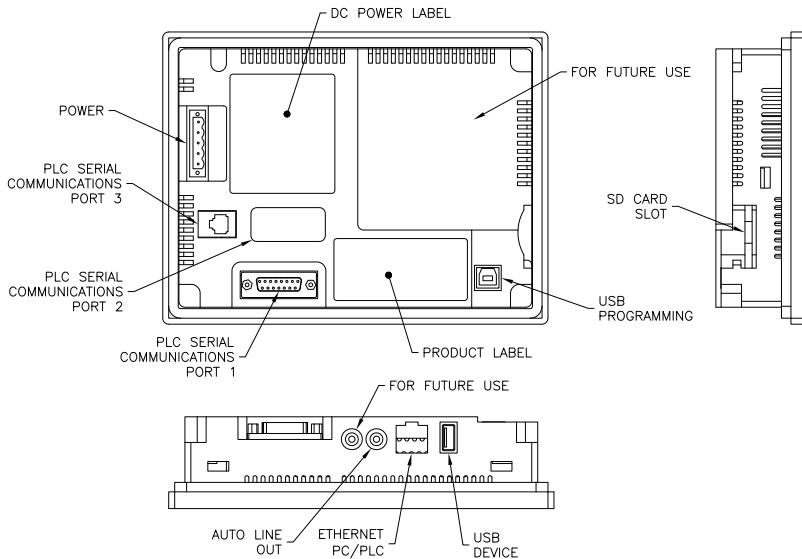

EA9-T7CL-R, EA9-T7CL

Dimensions, Inches [mm]

All the necessary mounting hardware is provided with the touch panel. Use the four mounting clips and screws to secure the touch panel to the cabinet or enclosure surface.

A template for marking the cutout dimensions on the mounting surface is provided in the box.

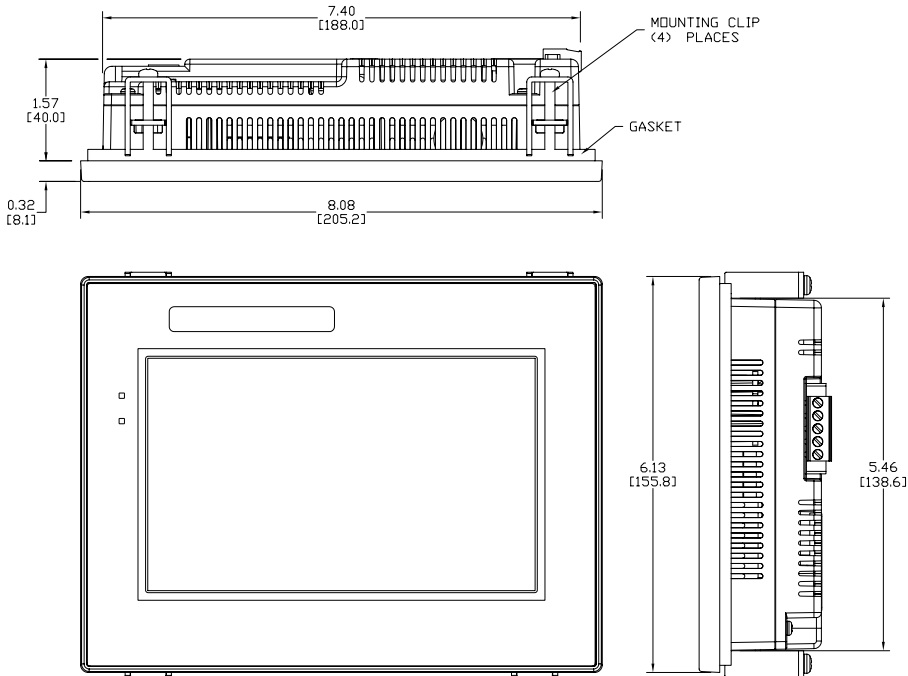

Enclosure Mounting Thickness Ranges and Mounting Clip Screw Torque

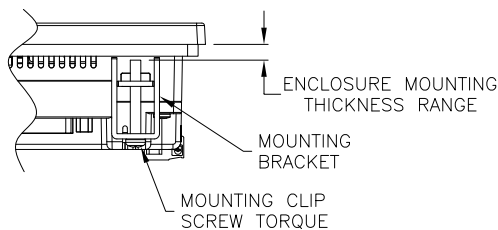

| Touch Panel Size | Enclosure Thickness Range | Mounting Clip Screw Torque | Material |
|--------------------------|---------------------------------|------------------------------------|----------|
| 6", 7", 8", 10" & 12" | 0.039 - 0.20 inch [1 - 5 mm] | 63 - 77 oz-in [0.45 - 0.55 Nm] | Metal |
| 10" Wide, 15" | 0.039 - 0.20 inch [1 - 5 mm] | 92 - 106 oz-in [0.65 - 0.75 Nm] | Metal |

Ports and Memory Expansion

EA9-T7CL-R

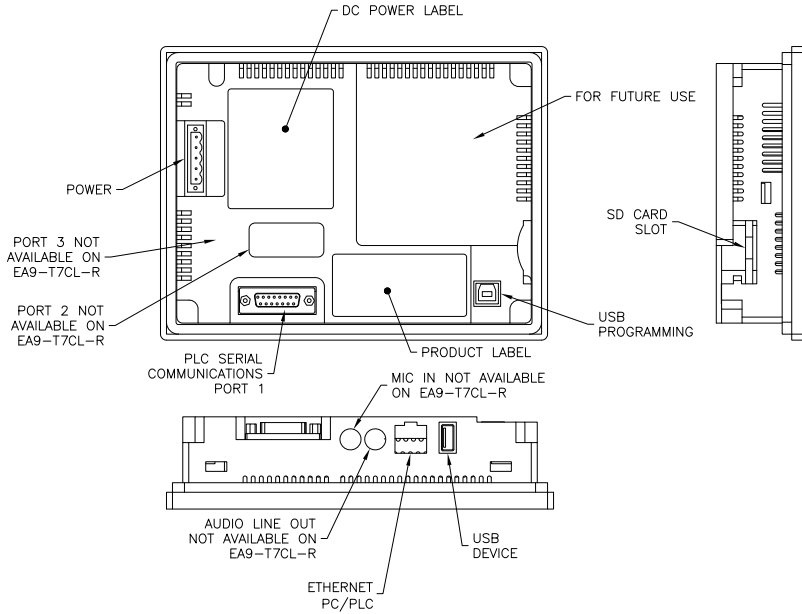

EA9-T7CL

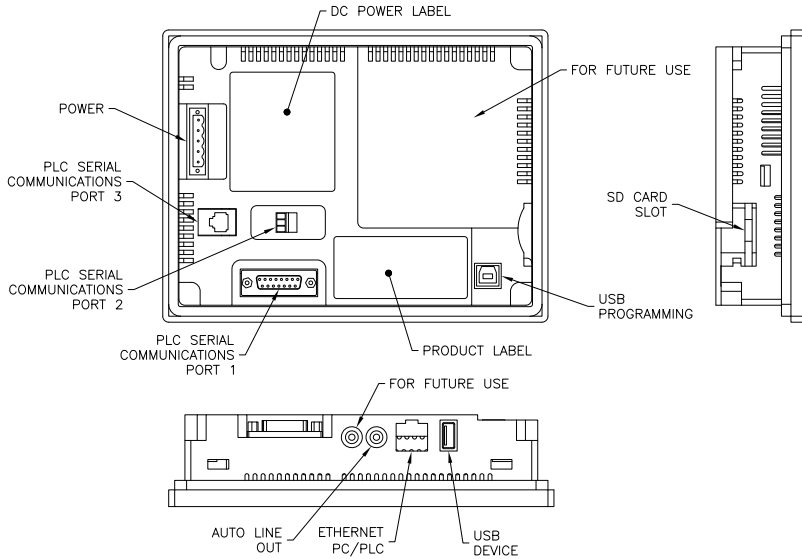

EA9-T8CL

Dimensions, Inches [mm]

All the necessary mounting hardware is provided with the touch panel. Use the four mounting clips and screws to secure the touch panel to the cabinet or enclosure surface.

A template for marking the cutout dimensions on the mounting surface is provided in the box.

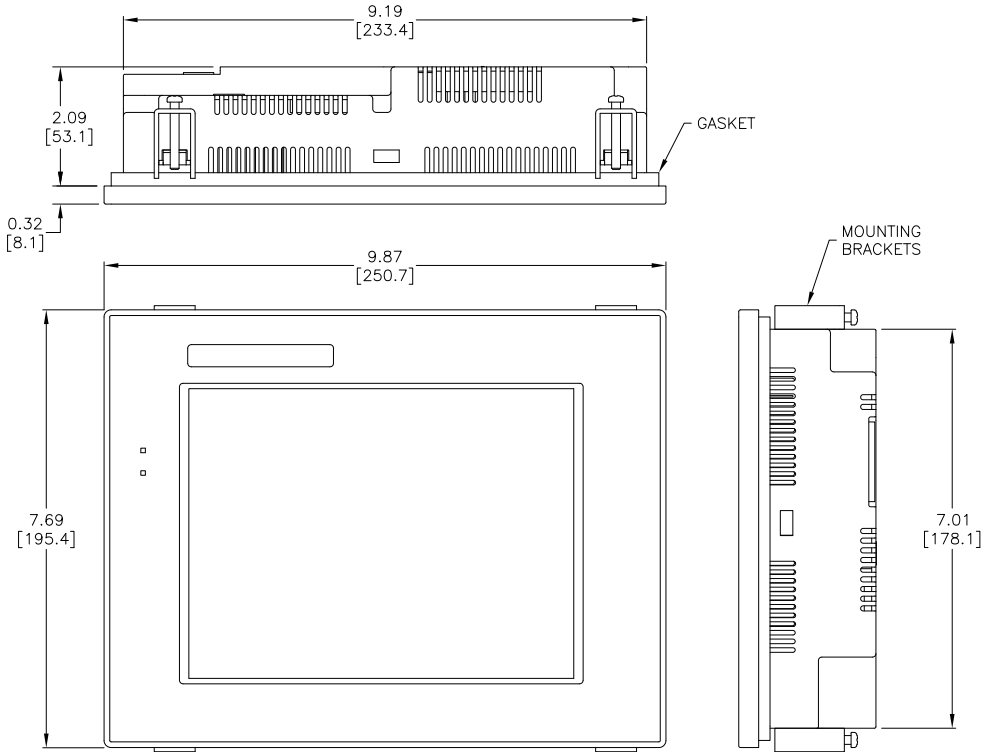

Enclosure Mounting Thickness Ranges and Mounting Clip Screw Torque

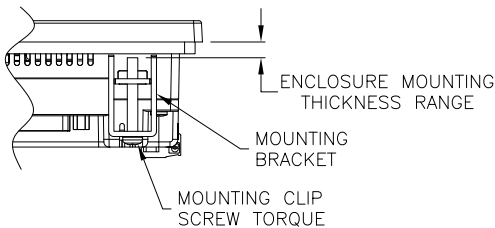

| Touch Panel Size | Enclosure Thickness Range | Mounting Clip Screw Torque | Material |
|--------------------------|---------------------------------|------------------------------------|----------|
| 6", 7", 8", 10" & 12" | 0.039 - 0.20 inch [1 - 5 mm] | 63 - 77 oz-in [0.45 - 0.55 Nm] | Metal |
| 10" Wide, 15" | 0.039 - 0.20 inch [1 - 5 mm] | 92 - 106 oz-in [0.65 - 0.75 Nm] | Metal |

Ports and Memory Expansion

EA9-T8CL

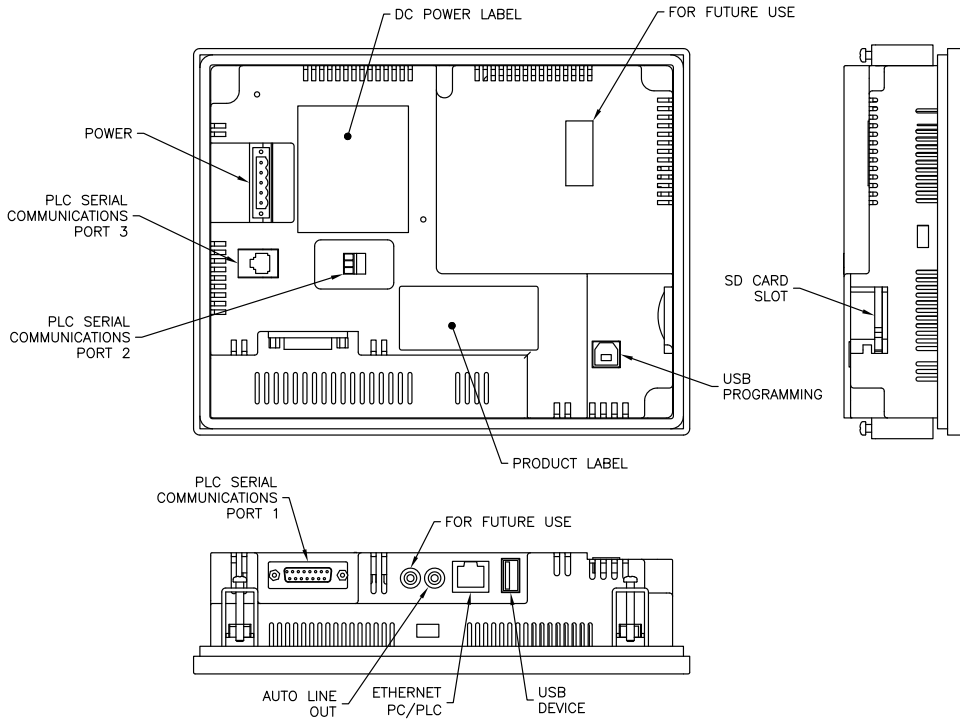

2

EA9-T10CL

Dimensions, Inches [mm]

All the necessary mounting hardware is provided with the touch panel. Use the eight mounting clips and screws to secure the touch panel to the cabinet or enclosure surface.

A template for marking the cutout dimensions on the mounting surface is provided in the box.

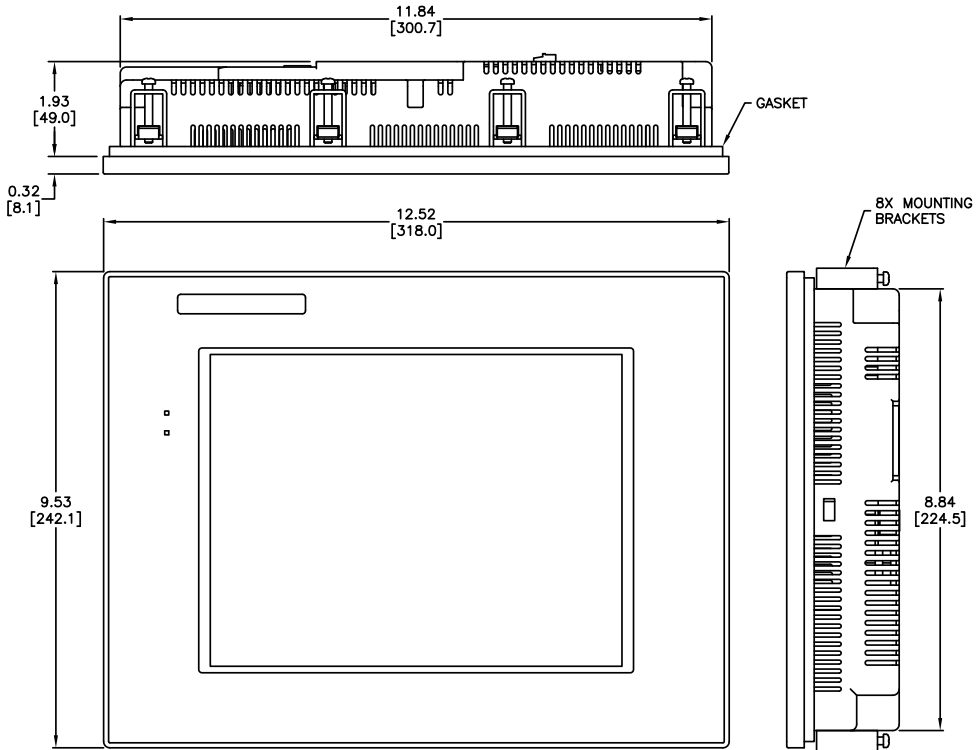

Enclosure Mounting Thickness Ranges and Mounting Clip Screw Torque

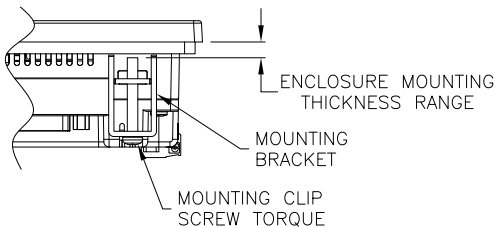

| Touch Panel Size | Enclosure Thickness Range | Mounting Clip Screw Torque | Material |
|--------------------------|---------------------------------|------------------------------------|----------|
| 6", 7", 8", 10" & 12" | 0.039 - 0.20 inch [1 - 5 mm] | 63 - 77 oz-in [0.45 - 0.55 Nm] | Metal |
| 10" Wide, 15" | 0.039 - 0.20 inch [1 - 5 mm] | 92 - 106 oz-in [0.65 - 0.75 Nm] | Metal |

EA9-T10WCL

Dimensions, Inches [mm]

All the necessary mounting hardware is provided with the touch panel. Use the eight mounting clips and screws to secure the touch panel to the cabinet or enclosure surface.

A template for marking the cutout dimensions on the mounting surface is provided in the box.

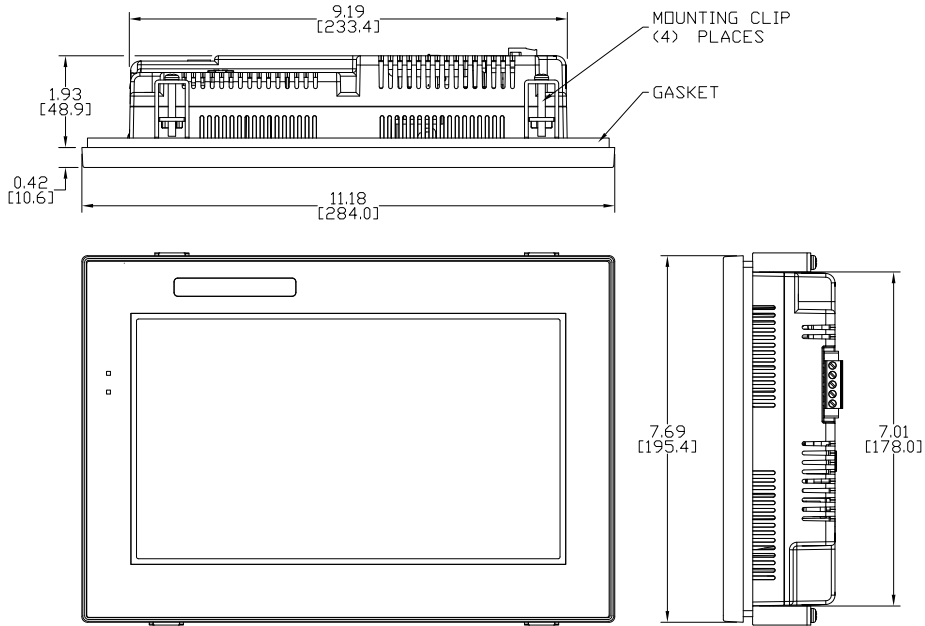

Enclosure Mounting Thickness Ranges and Mounting Clip Screw Torque

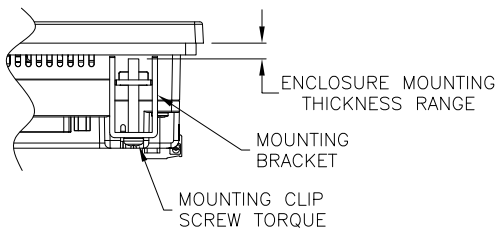

| Touch Panel Size | Enclosure Thickness Range | Mounting Clip Screw Torque | Material |
|--------------------------|---------------------------------|------------------------------------|----------|
| 6", 7", 8", 10" & 12" | 0.039 - 0.20 inch [1 - 5 mm] | 63 - 77 oz-in [0.45 - 0.55 Nm] | Metal |
| 10" Wide, 15" | 0.039 - 0.20 inch [1 - 5 mm] | 92 - 106 oz-in [0.65 - 0.75 Nm] | Metal |

Ports and Memory Expansion

EA9-T10CL

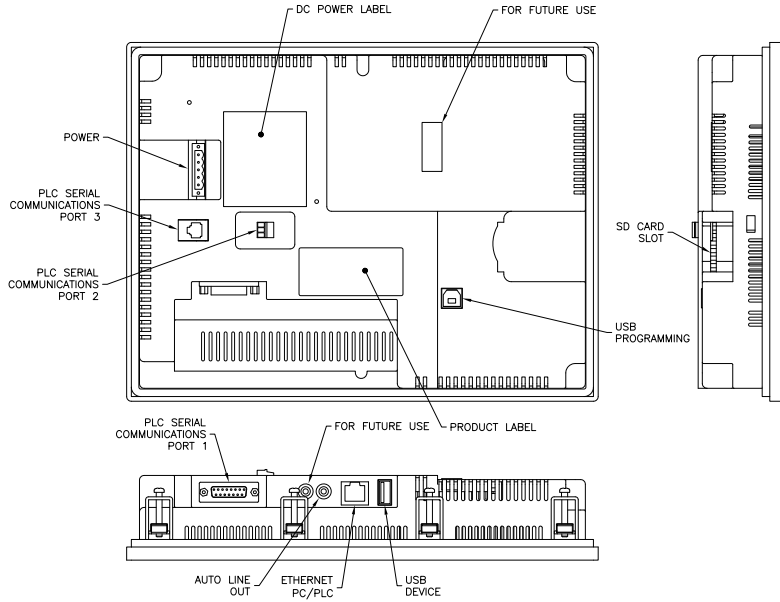

EA9-T10WCL

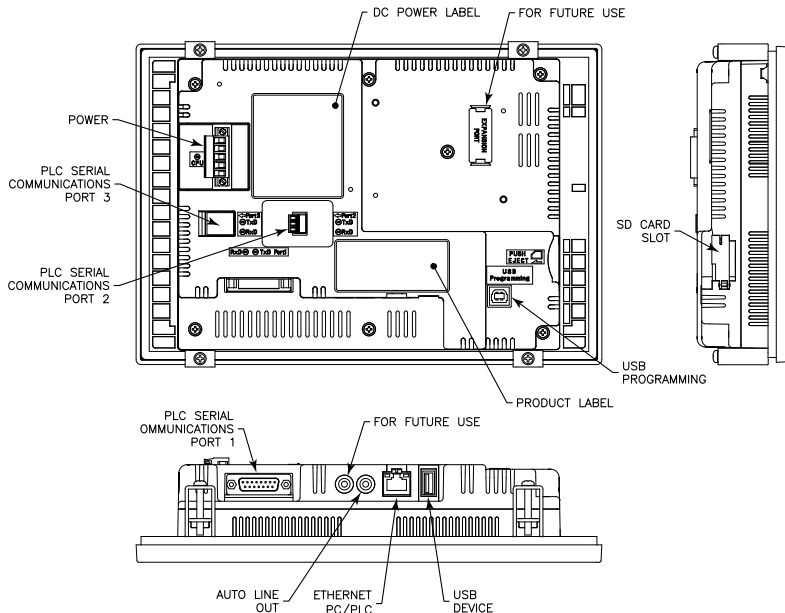

EA9-T12CL

Dimensions, Inches [mm]

All the necessary mounting hardware is provided with the touch panel. Use the eight mounting clips and screws to secure the touch panel to the cabinet or enclosure surface.

A template for marking the cutout dimensions on the mounting surface is provided in the box.

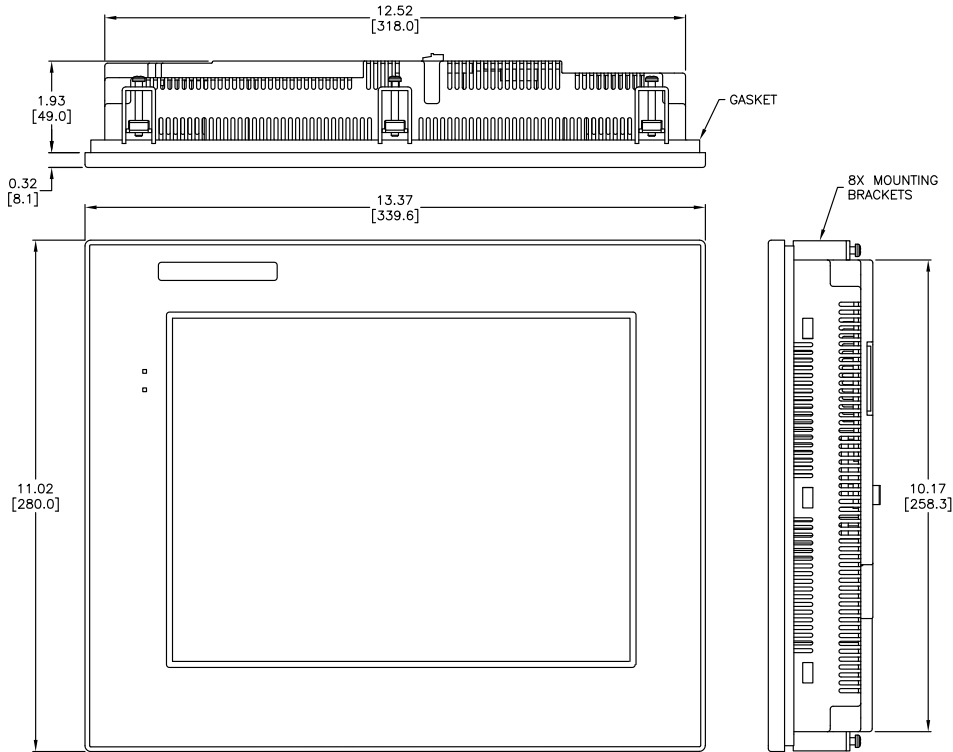

Enclosure Mounting Thickness Ranges and Mounting Clip Screw Torque

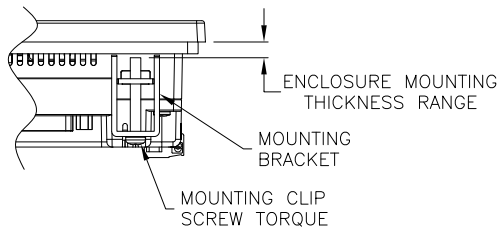

| Touch Panel Size | Enclosure Thickness Range | Mounting Clip Screw Torque | Material |
|--------------------------|---------------------------------|------------------------------------|----------|
| 6", 7", 8", 10" & 12" | 0.039 - 0.20 inch [1 - 5 mm] | 63 - 77 oz-in [0.45 - 0.55 Nm] | Metal |
| 10" Wide, 15" | 0.039 - 0.20 inch [1 - 5 mm] | 92 - 106 oz-in [0.65 - 0.75 Nm] | Metal |

Ports and Memory Expansion

EA9-T12CL

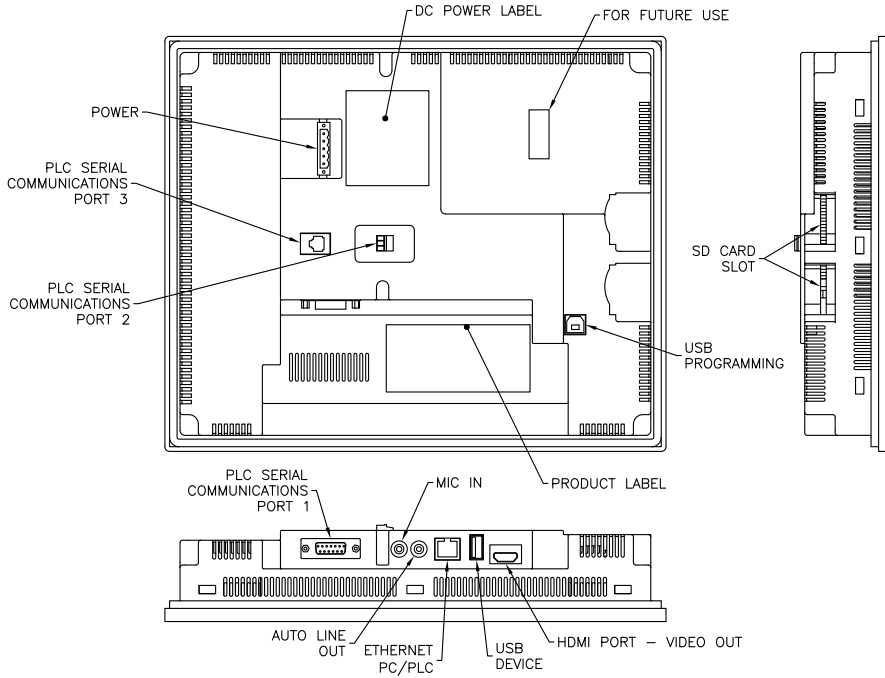

EA9-T15CL-R, EA9-T15CL

Dimensions, Inches [mm]

All the necessary mounting hardware is provided with the touch panel. Use the eight mounting clips and screws to secure the touch panel to the cabinet or enclosure surface.

A template is provided for marking the cutout dimensions on the mounting surface.

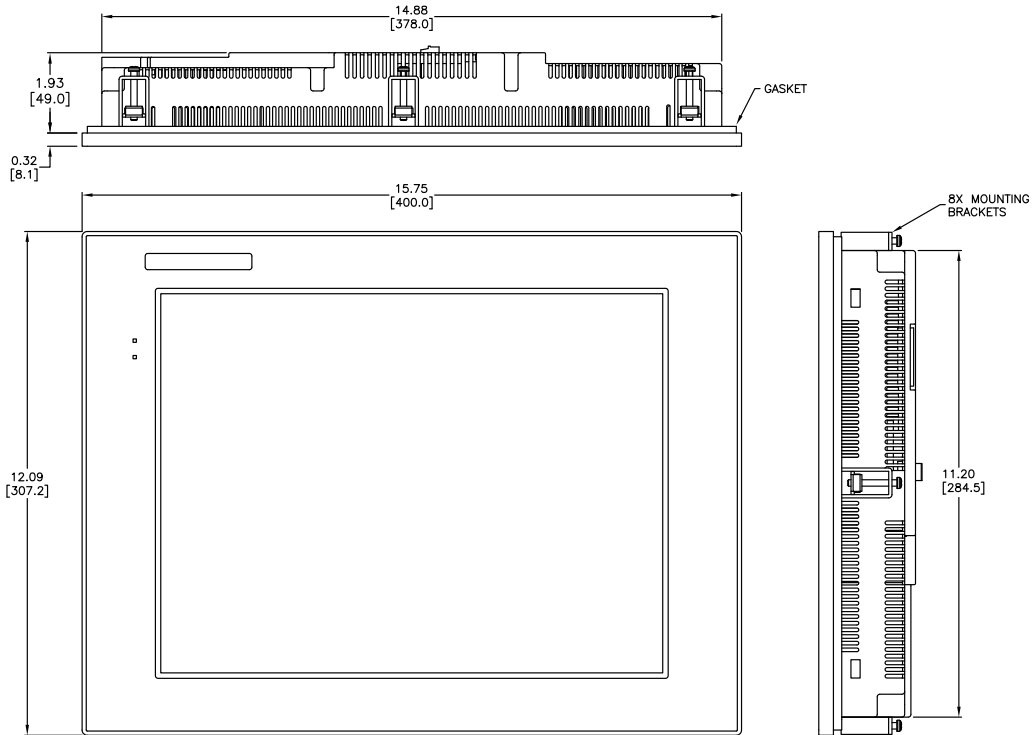

Enclosure Mounting Thickness Ranges and Mounting Clip Screw Torque

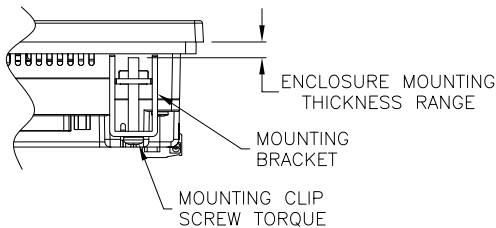

| Touch Panel Size | Enclosure Thickness Range | Mounting Clip Screw Torque | Material |
|--------------------------|---------------------------------|------------------------------------|----------|
| 6", 7", 8", 10" & 12" | 0.039 - 0.20 inch [1 - 5 mm] | 63 - 77 oz-in [0.45 - 0.55 Nm] | Metal |
| 10" Wide, 15" | 0.039 - 0.20 inch [1 - 5 mm] | 92 - 106 oz-in [0.65 - 0.75 Nm] | Metal |

Ports and Memory Expansion

EA9-T15CL-R

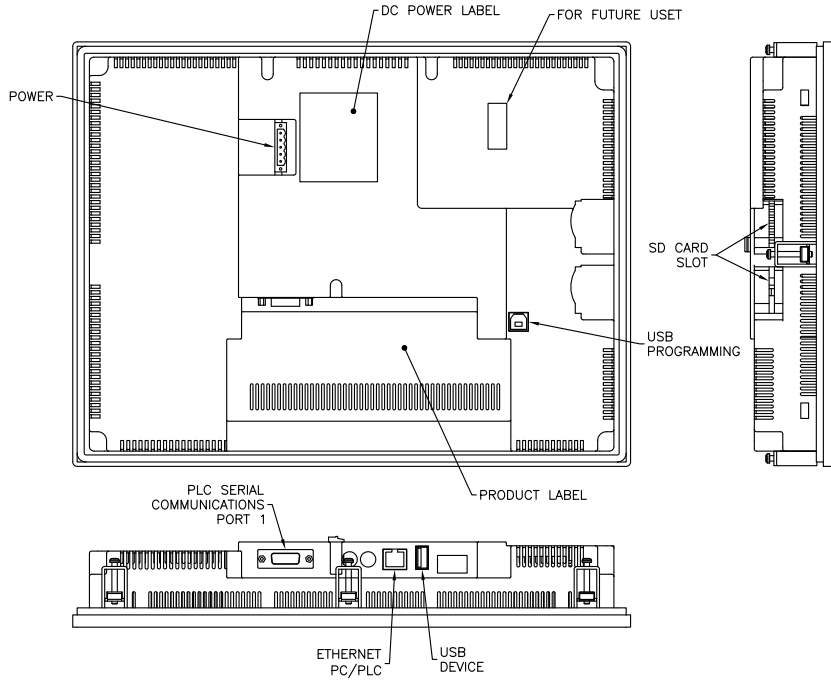

2

EA9-T15CL

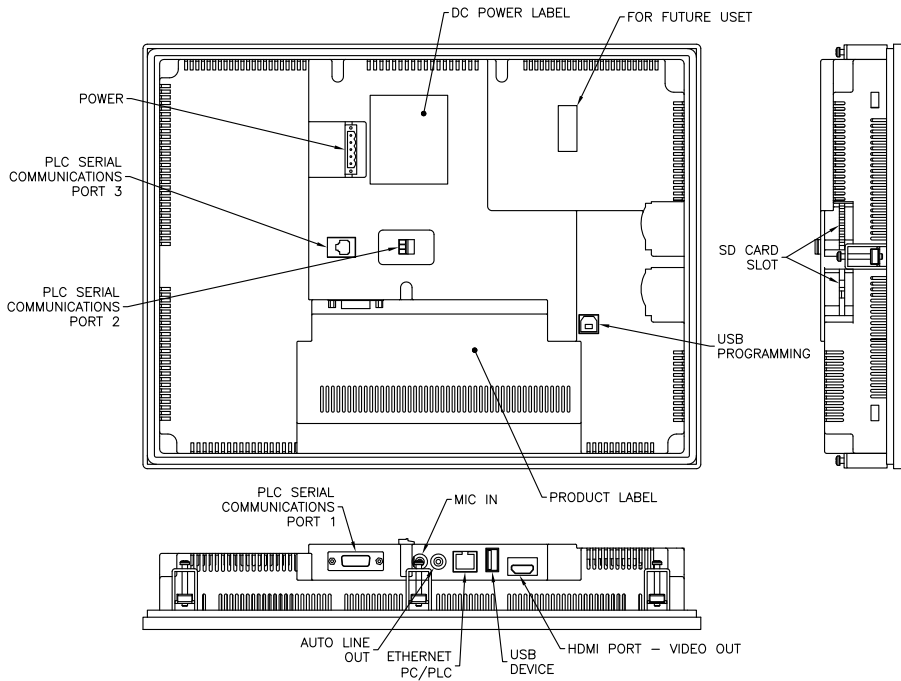

2

Mounting Clearances

The following drawing shows the mounting clearances for the *C-more* touch panel. There should be a minimum of 4 inches of space between all sides of the panel and the nearest object or obstruction and at least 1.72 inches between the rear of the panel and the nearest object or obstruction.

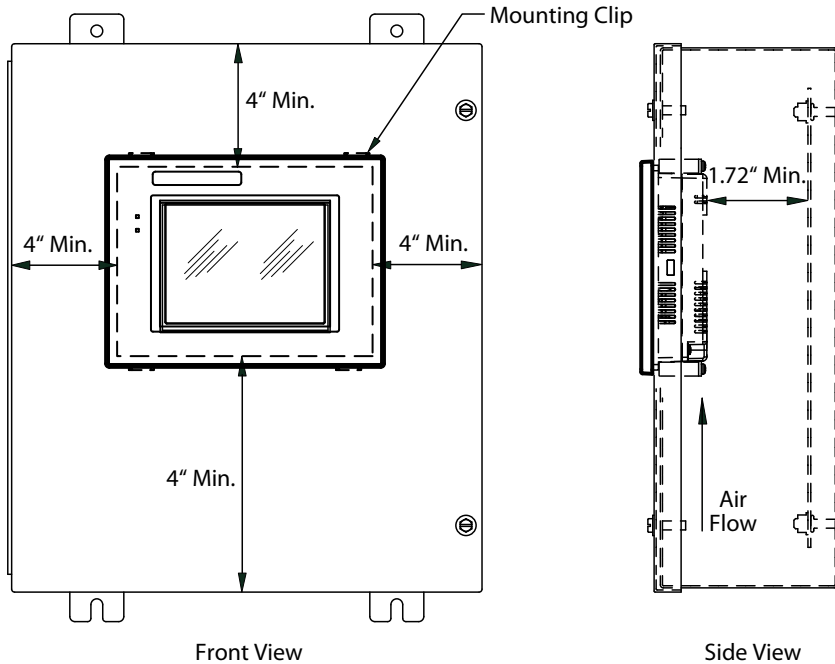

EA9-T15CL-R, EA9-T15CL Derating

If EA9-T15CL-R and EA9-T15CL are mounted off the vertical plane facing upward, the temperature shall be derated as shown below. Other panels may be mounted at any angle without derating consideration.

2

EA9-T15CL-R, EA9-T15CL

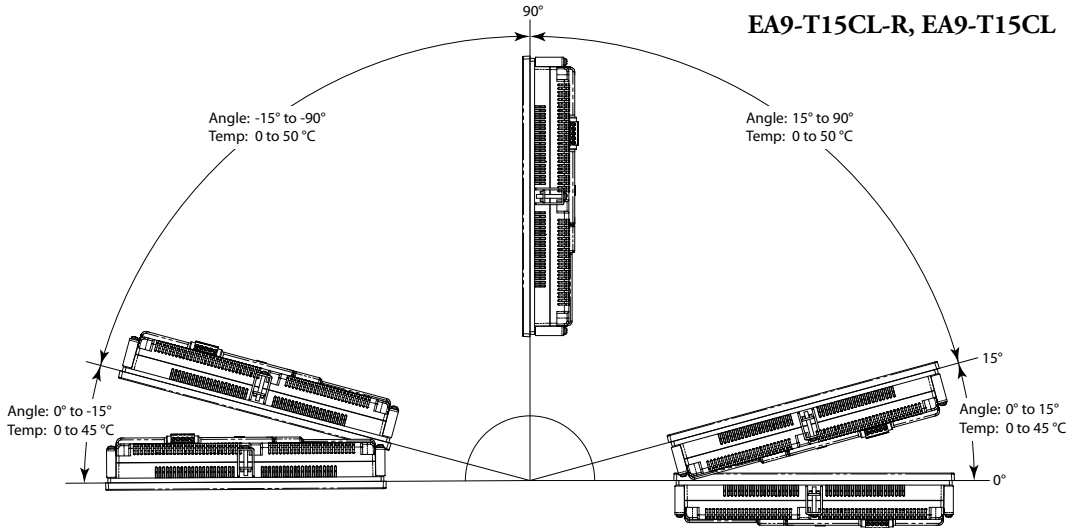

EA9-T15CL-R, EA9-T15CL
with EA-AC

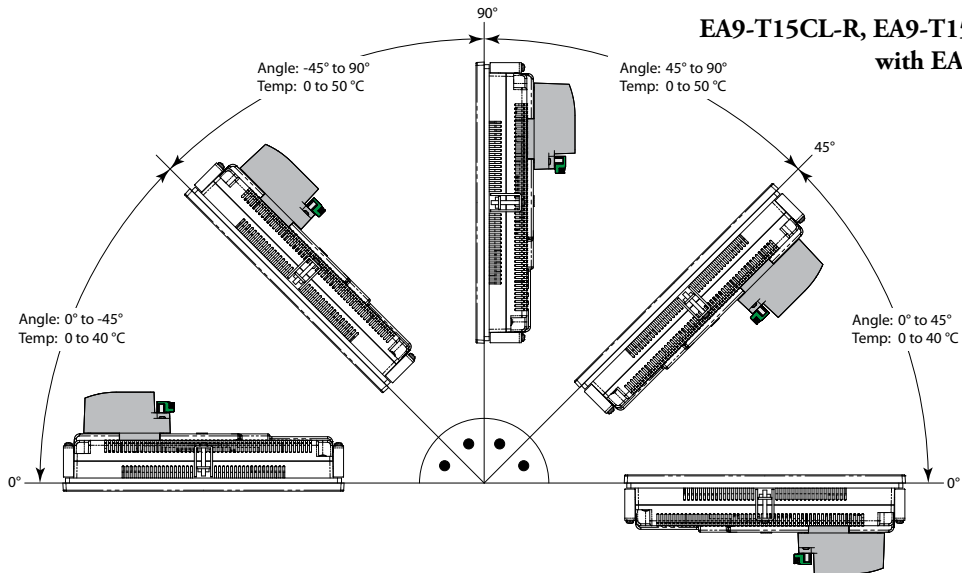

Communications Ports

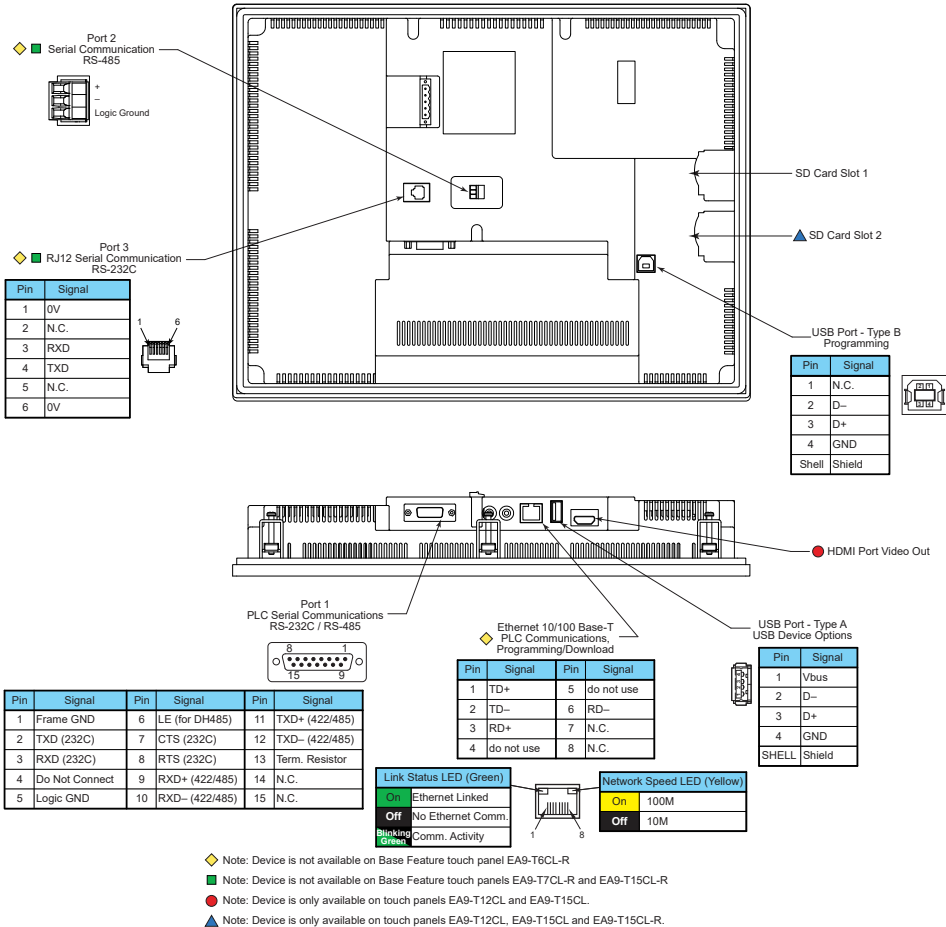

Ethernet Port

The Ethernet port can be used several ways: for programming the panel (downloading a project), for PLC communication, and for the advanced features, such as sending e-mail, web server, FTP access, and allowing users to access and control the panel remotely.

The Ethernet connector is an RJ-45 Module jack.



NOTE: EA9-T6CL-R does not include an Ethernet port and does not have these capabilities.

Refer to <http://c-more.automationdirect.com> for the latest driver information.

Communications Ports (cont'd)

USB Type B Port

Program *C-more* via the USB programming port. It's fast and easy, with no baud rate settings, parity, or stop bits to worry about. We stock standard USB cables for your convenience, such as part no. USB-CBL-AB15. The USB type B port can be used to upload or download projects to and from a PC (personnel computer).

USB Type A Port

The USB type A port is a standard feature for all models and can be used to connect various USB 2.0 HID (Human Input Device) devices to the panel, such as:

- USB pen drives, (ADC p/n USB-FLASH)
- USB keyboards
- USB barcode scanners
- USB card scanners

C-more can log data to the USB pen drive as well as restore projects to the panel from the pen drive. You can also back up project files and panel firmware.



NOTE: Output current is less than 200mA @ 5VDC.

Sound Interface (Audio Line Out)

When attached to an amplifier and speaker(s), *C-more* can play warning sounds, or pre-recorded messages such as: “conveyor is jammed”. Various “Objects” in the *C-more* programming software support sounds. *C-more* supports WAV type files. Sound files are stored in the sound library.

Audio WAV File Specifications

The *C-more* Audio Line Out port supports the following WAV file specifications:

Audio Format (codec): PCM

Audio Sample Rate: 44.1 kHz

Channels: 2 (stereo)

Audio Sample Size: 16-bit

Serial Communication Ports

Port 1

Connect to your serial controller network via Port 1. Port 1 is a 15-pin port that supports RS-232 and RS-422/485.

Port 2

Connect your RS-485 network via Port 2. Port 2 is provided with a 3-wire removable terminal block.

Port 3

Connect to your RS-232C device via Port 3. Port 3 is an RJ12 connection



NOTE: EA9-T6CL-R, EA9-T7CL-R and EA9-T15CL-R do not include Serial Ports 2 and 3.

HDMI Port Video Out

EA9-T12CL and EA9-T15CL include an HDMI Type A port to provide video output to a projector or monitor.

| Model | Supported Resolution |
|---------------------------|---|
| EA9-T12CL | SVGA 800 x 600 pixel |
| EA9-T15CL | XGA 1024 x 768 pixel |
| Output | Video Data - Same Screen as Panel |
| Sound Pass Through | Does not support Mic sound Pass Through |

User Defined LED

The user defined LED on the panel front bezel can be controlled from the project to illuminate red, green or orange. It can also be configured to blink these colors. Refer to the online help file provided with the programming software for details.

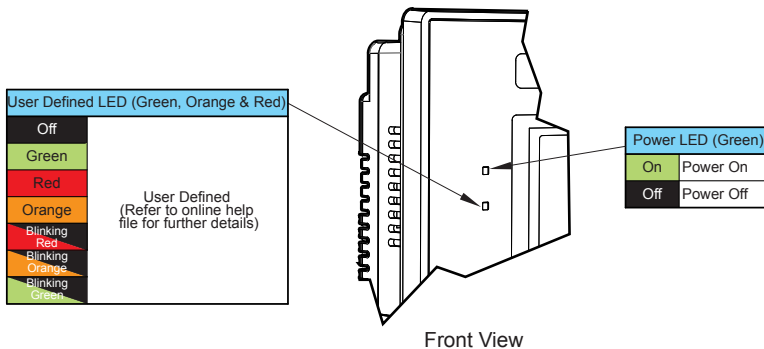

Handling External Memory Devices

Writing to External Memory Devices

Different types of numeric and text data from the *C-more* touch panel can be stored on an SD card or a USB memory device. Numeric data from Line Trend Graph and PID Faceplate Trend Graph objects may be stored. Text data from Lookup Text and Multi-state Text objects can also be stored.

Up to 16 objects may be configured in the C-more programming software to log data. Along with the 16 object limit, available storage on the external memory device is subject to the memory capacity of the SD card or USB memory device. One log file is created in a 24 hour period for each object. Additionally logging data is initially stored in the buffer in the panel MRAM and data is written to the external memory device:

- when 2kB of data is cached,
- when 20 records have been stored,
- periodically, once every 1 minute,
- when one of the “SYS Copy LogTo %device%” or “SYS %device% Eject” tags is turned on.
- when there is an email or FTP action
- when the System Screen is called
- when the panel date is changed

Memory Device Formatting

Memory Devices should be formatted according to the following guidelines to insure best performance and integrity of logged data.

| Item | | Capacity | Supported Resolution | Supported |
|-------------------|------|----------------|----------------------|-----------|
| USB Memory Device | | up to 2GB | FAT | Yes |
| | | 4GB to 32GB | FAT 32 | Yes |
| | | 64GB or larger | exFAT | Yes |
| SD Card | Type | | | |
| | SD | up to 2GB | FAT | Yes |
| | SDHC | 4GB to 32GB | FAT 32 | Yes |
| | SDXC | | exFAT | No |

SD cards must be formatted using the SD formatter provided by the SD Association at www.sdcard.org using the standard allocation unit size for best performance.

Minimizing Data Errors

To minimize data errors when logging data to external memory, consider the following:

- Do not turn off power to the *C-more* touch panel while the external memory device is being accessed. The optional EA-AC power adapter is designed to protect external memory devices from damage during power failure.
- Do not remove any external memory device with the device is being accessed by the *C-more* panel.

The following internal tags should be used to monitor, access and safely remove external memory devices:

SYS SD1 WriteStatus
 SYS SD2 WriteStatus
 SYS USB WriteStatus
 SYS Copy LogToSD1
 SYS Copy LogToSD2
 SYS Copy LogToUSB
 SYS SD1 Eject
 SYS SD2 Eject
 SYS USB Eject
 SYS SD1 ReadyToUse
 SYS SD2 ReadyToUse
 SYS USB ReadyToUse

- Be sure to backup the memory device at regular intervals.
- If you suspect the memory device is bad, you may want to use a PC to re-format the device, or use a known good memory device.
- The number of times the memory device can be written to is limited. Consequently, logging frequently will may shorten the service life of the memory device. Using slower sample rates will increase the life of the device.

Monitoring Available Memory

Each external memory device can be monitored and events can be configured to alert the user when available memory is approaching the maximum capacity of the external memory device. The following internal tags allow external memory devices data to be monitored:

SYS SD1 TotalMemory
 SYS SD1 FreeMemory
 SYS SD1 UsedMemory
 SYS SD2 TotalMemory
 SYS SD2 FreeMemory
 SYS SD2 UsedMemory
 SYS USB TotalMemory
 SYS USB FreeMemory
 SYS USB UsedMemory

Refer to the *C-more* programming software online help files for additional information on system tags and managing data logging devices.

File Name Limitations

There is a limit of 999 file names with the same first four characters. Internal file names are restricted by the DOS 8-character-dot-3-character limit. Therefore trend log files are identified internally by the first four characters of the object name plus tilde plus a three digit number.

Examples are:

TREND GRAPH EAST CHILLER TEMP_130925.txt is saved internally as TREN-001.txt
TREND GRAPH WEST CHILLER TEMP_130925.txt is saved internally as TREN-002.txt

As new log files are created in each 24 hour period, these files count against the maximum of 999 files. If multiple graph objects appear on one screen, the files will be identified internally by the first Two Characters of the screen name plus the first Two Characters of the object name plus tilde plus three digit number.

To maximize storage capabilities on external memory devices use screen names that have unique characters in the first four digits and object names that are unique in the first two characters.



NOTE: When the 999 filename limit is reached, the oldest files will automatically be deleted and logging will continue.

Power Loss Retention

When a power loss is detected, the panel will attempt to complete all data logging operations safely.

The power retention while using a DC power is not long enough to complete writes to an SD Card or USB device. An Uninterruptable Power Supply (UPS) should be considered.

| Power Loss Detection (at 25°C) | |
|--------------------------------|---|
| Power Supply | Detect Loss |
| DC (Panel only) | 8.9 VDC |
| EA-AC | 67VAC (6 - 10 inch) 70VAC (12 - 15 inch) |

Chemical Compatibility

The *C-more* touch panels comprise three different materials that may be exposed to outside elements: a gasket, a screen sheet and a bezel.

- Gasket material is silicone.
- Screen sheets are PET.
- Panel bezels are ABS plastic.