

EchoTouch®

Ultrasonic Liquid Level Transmitter



LU20 Series Manual



An ultrasonic sound wave is pulsed two times per second from the base of the transducer. The sound wave reflects against the process medium below and returns to the transducer. The microprocessor based electronics measure the time of flight between the sound generation and receipt, and translates this figure into the distance between the transmitter and process medium below.

TABLE OF CONTENTS

- Specifications 3
 - Control Drawings 4
 - Dimensions 4
 - Components 4
- Safety Precautions 5
- Menu / Definitions..... 6
- Configuration 8
 - Steps for Basic Configuration..... 8
 - Selecting Units of Operation..... 8
 - Configure Sensor’s Current Range 8
 - Configure Operational Range..... 9
 - Configure Fail-Safe 9
- Wiring 10-13
- Installation 14
 - Mounting Guide..... 14
 - Fitting Selection 15
 - Tank Adapter..... 15
 - Riser..... 15
 - Flange 15
 - Side Mount Fitting 16
 - Stand Pipe..... 16
- Appendix 17
 - Factory Settings and Reset..... 17
 - Changing Display units 17
- Troubleshooting..... 18
 - Other Hints..... 19
 - Testing the transmitter 19
 - User Settings 19
- Warranty, Returns and Limitations..... 20

Specifications

Range:	0.5 to 18 feet (15cm to 5.4m)
Accuracy:	± 0.25% of range
Resolution:	0.125" (3mm)
Frequency:	50kHz
Pulse rate:	2 pulses per second
Beam width:	8° conical
Dead band:	0.5' (15cm) minimum
Display type:	4 segment LCD
Display units:	Inch or cm
Memory:	Non-volatile
Supply voltage:	GP: 12-36 VDC IS: 12-32 VDC
Max loop resistance:	GP: 900 Ohms @ 36 VDC IS: 900 Ohms @ 32 VDC
Signal output:	GP: 4-20mA, 12-36 VDC IS: 4-20mA, 12-32 VDC
Signal invert:	4-20 mA / 20-4 mA
Configuration:	Push button
Fail-Safe diagnostics:	Revert to 4mA, 22mA or remains constant
Temperature rating:	F: -40° to 140°. C: -40° to 60°
Temp. compensation:	Automatic over entire range
Pressure rating:	30 psi (2 bar) @ 25 °C., derated @ 1.667 psi (.113 bar) per °C. above 25 °C.
Enclosure rating:	NEMA 4X (IP65)
Enclosure material:	Polypropylene (PP), U.L. 94VO
Transducer material:	Polyvinylidene Fluoride (PVDF)
Process mount:	2" NPT (2" G)
Mount gasket:	Viton (2") metric only
Conduit entrance:	Single, 1/2" NPT
CE compliance:	EN 50082-2 immunity EN 55011 emission
CSA certificate:	LR79326-10

* GP = General Purpose
* IS = Intrinsically Safe

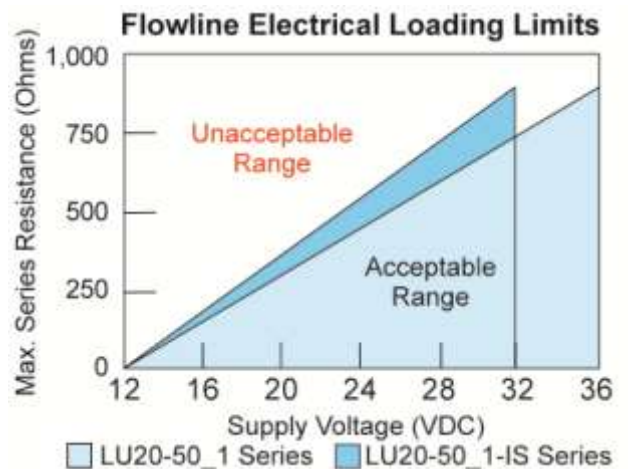
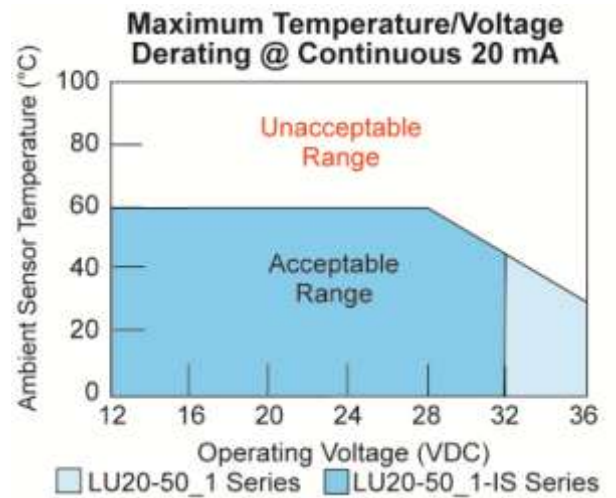
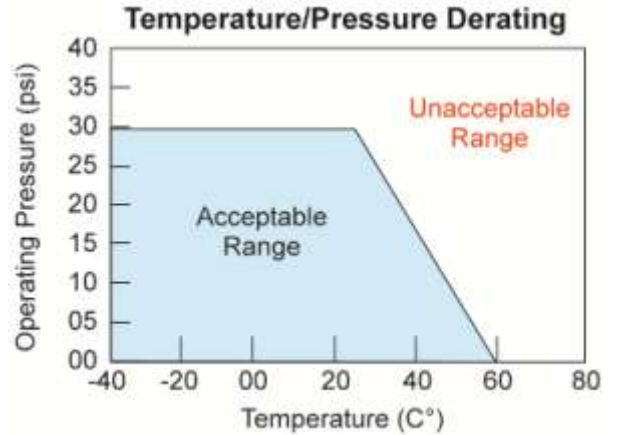

INTRINSICALLY SAFE CONTROL DRAWINGS

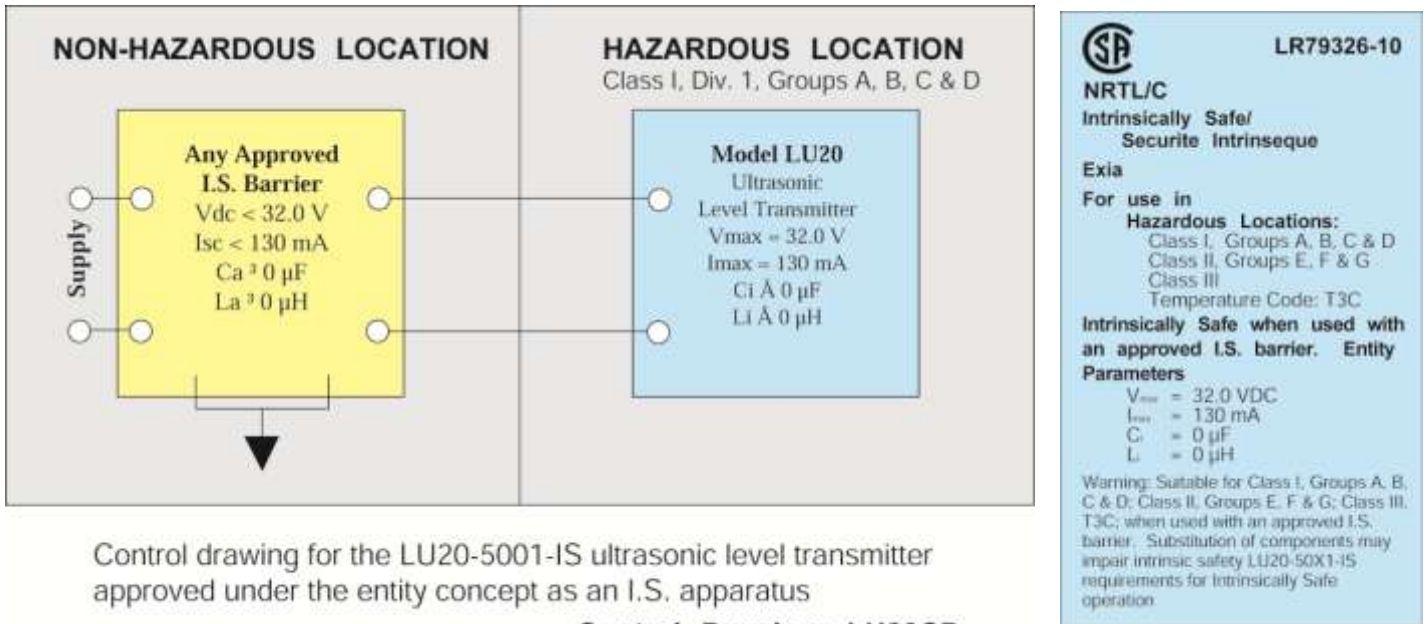

Control drawing for the LU20-5001-IS ultrasonic level transmitter approved under the entity concept as an I.S. apparatus

Control Drawing: LU20CD Rev. 7-24-97

Intrinsically Safe Approvals

Class I, Groups A, B, C & D; Class II, Groups E, F & G; Class III; TC3

Intrinsically Safe Entity Parameters

$V_{max} < 32.0 \text{ V}$; $I_{max} < 130 \text{ mA}$; $C_a = 0 \mu\text{F}$; $L_a = 0 \mu\text{H}$

Part#	Description	Thread
LU20-5001	General Purpose	2" NPT
LU20-5061	General Purpose	2" G
LU20-5001-IS	Intrinsically Safe	2" NPT
LU20-5061-IS	Intrinsically Safe	2" G

Dimensional Info:

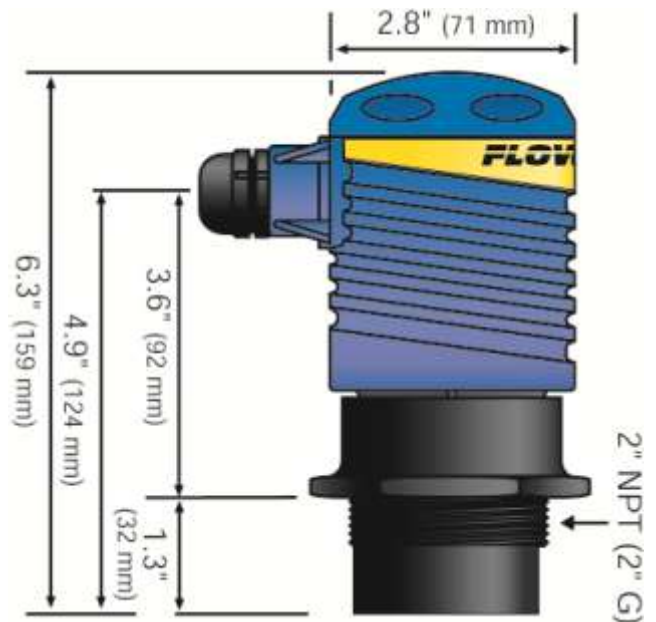

-
- ⚠ **About this Manual:** PLEASE READ THE ENTIRE MANUAL PRIOR TO INSTALLING OR USING THE PRODUCT. This manual includes information on all four versions of the continuous ultrasonic level transmitter from Flowline; model LU20-50_1 and LU20-50_1-IS. Please refer to the part number located on the sensor label to verify the exact model which you have purchased.
 - ⚠ **User's Responsibility for Safety:** Flowline manufactures a wide range of liquid level sensors and technologies. While each of these technologies are designed to operate in a wide variety of applications, it is the user's responsibility to select a technology that is appropriate for the application, install it properly, perform tests of the installed system, and maintain all components. The failure to do so could result in property damage or serious injury.
 - ⚠ **Proper Installation and Handling:** Because this is an electrically operated device, only properly trained staff should install and/or repair this product. Use a proper sealant with all installations. **NOTE:** Always install the 2" Viton gasket with the LU20-5061 and the LU20-5061-IS. The G threaded version of the Echotouch will not seal unless the gasket is installed properly. Never over tighten the transmitter within the fitting. Always check for leaks prior to system start-up.
 - ⚠ **Wiring and Electrical:** A supply voltage of 12-36 VDC is used to power the LU20-50_1 transmitter and supply voltage of 12-32 VDC is used to power the LU20-50_1-IS. The sensor system should never exceed a maximum of 36 VDC for the LU20-50_1 and 32 VDC for the LU20-50_1-IS. Electrical wiring of the sensor should be performed in accordance with all applicable national, state, and local codes.
 - ⚠ **Temperature and Pressure:** The LU20 is designed for use in application temperatures from -40 °C (-40 °F) to 60 °C (140 °F), and for use at pressures up to 30 psi @ 25 °C, derated @ 1.667 psi per °C above 25 °C.
 - ⚠ **Material compatibility:** The continuous ultrasonic level transmitter, LU20, is made of two materials. The enclosure is of Polypropylene (PP) and the transducer is made of Polyvinylidene fluoride (PVDF). Make sure that the model which you have selected is chemically compatible with the application liquids. While the transmitter housing is liquid resistant when installed properly, it is not designed to be immersed. It should be mounted in such a way that it does not normally come into contact with fluid.
 - ⚠ **Flammable, Explosive and Hazardous Applications:** Only the LU20-50_1-IS is rated for use in hazardous locations. Refer to the certificate of compliance for all applicable intrinsically safe ratings and entity parameters for the LU20-50_1-IS. Refer to the National Electric Code (NEC) for all applicable installation requirements in hazardous locations. **DO NOT USE THE LU20-50_1 GENERAL PURPOSE TRANSMITTER IN HAZADROUS LOCATIONS.**
 - ⚠ **Make a Fail – Safe System:** Design a fail–safe system that accommodates the possibility of transmitter or power failure. In critical applications, Flowline recommends the use of redundant backup systems and alarms in addition to the primary system.

Getting around: Echotouch is configured by the use of four push buttons (UP, DOWN, MENU and SET) and a LCD display. The display will always read the distance from the bottom of the sensor to the surface of the liquid (air gap).

Main Menu: Holding down the MENU button will scroll down the main menu of the Echotouch.

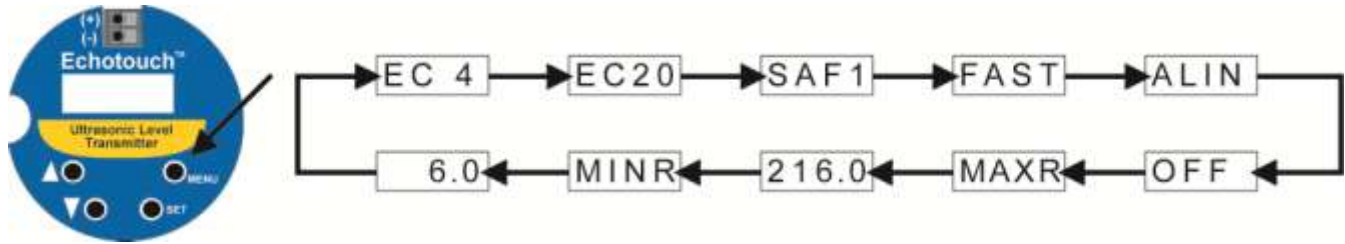

DEFINITIONS

EC4: This is the 4 mA setting for the LU20. The EC4 is the distance from the bottom of the LU20 to the 4 mA set point. Typically, the EC4 or 4mA setting is at the bottom of the tank. The further away from the sensor, the larger the number will be. This setting is measured in either inches or centimeters on the display.

EC20: This is the 20 mA setting for the LU20. The EC20 is the distance from the bottom of the LU20 to the 20 mA set point. Typically, the EC20 or 20 mA setting is at the top of the tank. The closer to the sensor, the smaller the number will be. This setting is measured in either inches or centimeters on the display.

Reversing the 4-20 mA signal: Setting the EC4 at the bottom of the tank and EC20 at the top of the tank will create a 4-20 mA output that has 4 mA at empty and 20 mA at full. To reverse the 4-20 mA signal, simply set EC4 at the top of the tank and EC20 at the bottom of the tank.

SAF1/SAF2/SAF3: This is the fail-safe setting for the LU20. Use the SAF_ setting to determine a fail-safe mode for the current signal. When [SAF1] is set, the current will increase to 22 mA if the signal becomes LOST. When [SAF2] is set, the current will decrease to 4 mA if the signal becomes LOST. When [SAF3] is set, the current will remain constant if the signal becomes LOST.

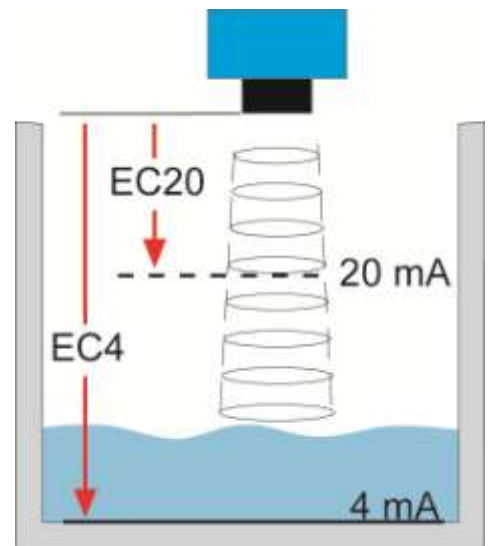

LOST: A LOST state will occur when the sensor does not receive a return sound pulse signal. When this occurs, the display will show LOST and the current output will default to the SAF_ setting. The sensor will remain in this condition until a valid signal is acquired. No values in the MENU can be changed until the LOST condition has been resolved.

FAST/SLOW: Setting for echo averaging as well as the reaction time for SAF_ setting in the LU20:

FAST: Is the typical and default setting for the LU20 to operate. The LU20 will average 2 signal responses per second and update every second. In FAST mode, the sensor will continue to search for a valid reading for 30 seconds before going into the LOST state.

SLOW: Is designed to help dampen out effects caused by severe turbulence. The LU20 will average signal returns over the preceding 10 seconds. In SLOW mode, the sensor will continue to search for a valid reading for 2.5 minutes before going into the LOST state.

TO CHANGE THE FAST/SLOW SETTING, FOLLOW THE STEPS BELOW

1. Hold [MENU] key until FAST or SLOW appears in the display.
2. Release [MENU] key and hold [SET] key to toggle between FAST and SLOW.
3. When desired setting is reached, release [SET] key. The last display setting will be locked into memory.

ALIN: Use this mode as an aid to leveling the sensor installed in a self-aligning or rotational bulk head fitting. Display will show the return signal strength in dB's. For optimum alignment, first energize the unit and receive a valid return signal. Then select the ALIN mode and adjust the LU20 until the display is maximized. Typical readings range between 2 and 60 dB's.

ON/OFF: This is the actual activation setting for ALIN mode. Default is [OFF]. Set to [ON] to view the ALIN readings. The ALIN mode must be turned [OFF] when alignment is completed.

TO ALIN A SENSOR, FOLLOW THE STEPS BELOW

1. Hold [MENU] key until OFF appears in the display.
 - a. OFF will appear right after ALIN
2. Release [MENU] key and immediately hold [SET] key to toggle from OFF to ON.
3. Release [SET] key. The LU20 is now in ALIN mode.
4. Adjust the sensor so the display shows the largest value.
 - a. When the highest value is shown, lock the sensor in place.
5. To exit ALIN mode, repeat steps 1-4 changing from ON to OFF.

MAXR: The MAXR sets the maximum tank height and will filter out all returns greater than this value. Regardless of how the EC4 and EC20 are set, set MAXR to the Empty tank distance or greater.

(Value): The number after MAXR shows the setting for MAXR. This value is the actual MAXR setting that can be changed for the application. The maximum distance is 216.0 inches.

MINR: The MINR value is the dead band closest to the transducer face where no signal will be generated. The MINR sets the minimum distance between the liquid and the transducer. Regardless of how the EC4 and EC20 are set, set MINR to the FULL tank distance.

(Value): The number after MINR shows the setting for MINR. This value is the actual MINR setting that can be changed for the application. The minimum distance is 6.0 inches.

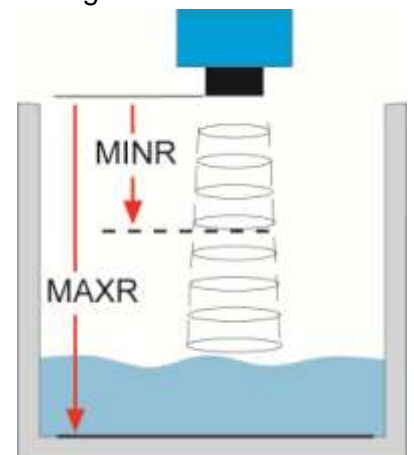

STEPS FOR BASIC CONFIGURATION

1. Select and Set the units of operation.
2. Configure the Sensor's Current Range using the EC4 and EC20 settings in the main menu.
 - a. The tank level does not need to be empty or full for this operation.
3. Set the Operational Range using the MAXR and MINR settings in the main menu.
 - a. The tank level does not need to be empty or full for this operation.
4. Select the Fail-Safe setting using the SAF_ setting in the main menu.

SELECTING UNITS OF OPERATION (INCHES OR CM)

The default for the Echotouch is to display in inches. If power is removed, the sensor will remain in the selected mode. This operation selects the units of operation for the configuration of the transmitter. This selection has no effect on the output of the sensor. The 4-20 mA output can be scaled to read in any engineering units.

To change to centimeters



1. Remove power to the LU20 and wait 10 seconds.
2. Simultaneously press [Δ] and [SET] while adding power to the transmitter.
3. The LU20 will now read in centimeters.

To change to inches



1. Remove power to the LU20 and wait 10 seconds.
2. Simultaneously press [∇] and [SET] while adding power to the transmitter.
3. The LU20 will now read in inches.

CONFIGURE THE SENSOR'S CURRENT RANGE USING EC4 AND EC20

EC4:

1. Measure the distance from the bottom of the sensor to the desired EC4 set point.
2. Hold [MENU] key until EC4 appears in display.
3. Release [MENU] key and wait until a value appears.
 - a. The value that appears is the current distance from the sensor to the surface of the liquid.
4. Immediately press the [Δ] or [∇] keys to view the memory value for EC4.
5. Use the [Δ] or [∇] keys to raise or lower the display to the desired value.
 - a. If the keys remain untouched for more than 3 seconds, the sensor will exit the menu.
6. Press the [SET] key to enter this value as the new EC4 set point.

EC20:

1. Measure the distance from the bottom of the sensor to the desired EC20 set point.
2. Hold [MENU] key until EC20 appears in display.
3. Release [MENU] key and wait until a value appears.
 - a. The value that appears is the current distance from the sensor to the surface of the liquid.
4. Immediately press the [Δ] or [∇] keys to view the memory value for EC20.
5. Use the [Δ] or [∇] keys to raise or lower the display to the desired value.
 - a. If the keys remain untouched for more than 3 seconds, the sensor will exit the menu.
6. Press the [SET] key to enter this value as the new EC20 set point.

SET OPERATIONAL RANGE USING MAXR AND MINR

MAXR:

1. Measure the distance from the bottom of the sensor to the desired MAXR set point.
2. Hold [MENU] key until the value after MAXR appears in the display.
 - a. This value is the current MAXR setting.
3. If this is acceptable, press [SET] to lock the value as the MAXR setting. If not, use the [Δ] or [▽] keys to raise or lower the value to the desired setting.
4. Press the [SET] key to enter this value as the new MAXR setting.

MINR:

1. Measure the distance from the bottom of the sensor to the desired MINR set point.
2. Hold [MENU] key until the value after MINR appears in the display.
 - a. This value is the current MINR setting.
3. If this is acceptable, press [SET] to lock the value as the MINR setting. If not, use the [Δ] or [▽] keys to raise or lower the value to the desired setting.
4. Press the [SET] key to enter this value as the new MINR setting.

SELECT THE FAIL-SAFE SETTING

SAF_:

1. Hold [MENU] key until SAF1, SAF2, or SAF3 appears in the display.
2. Release [MENU] key and hold [SET] key to toggle between SAF1, SAF2 and SAF3.
3. When desired setting is reached, release [SET] key. The last display setting will be locked into memory.

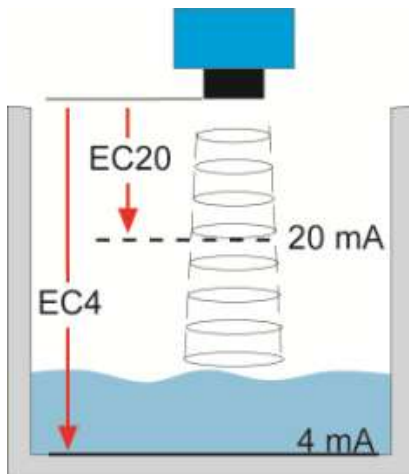

EC4 and EC20 Distances Shown Above

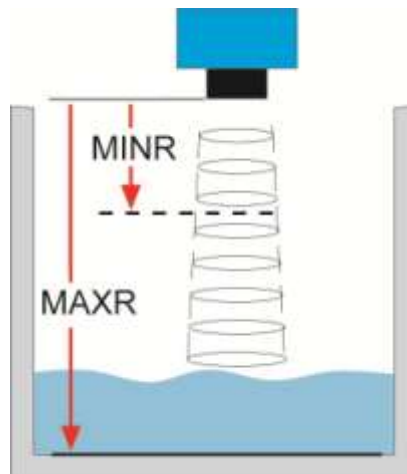

MAXR and MINR Distances Shown Above

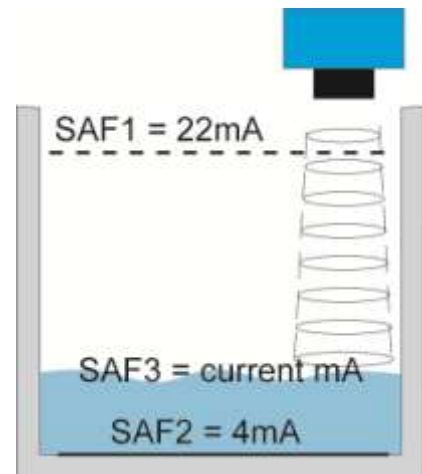

SAF1, SAF2 & SAF3 Settings Shown Above

The LU20-50_1 requires 12-36 VDC power with at least with 25mA supply in order to operate.

Wiring to the DataPoint LC52 Series Level Controller

Wiring to a Generic Loop Powered Display

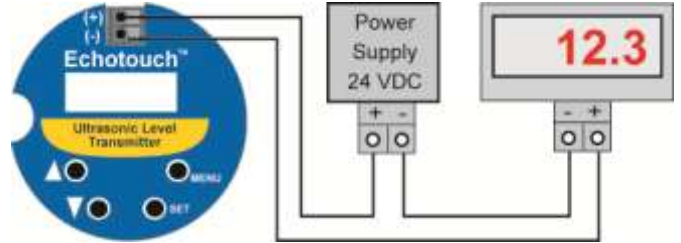

Wiring to the DataView LI55 Series Level Controller

Wiring to a Generic PLC

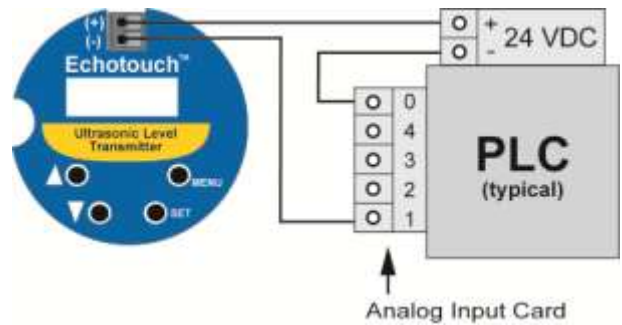
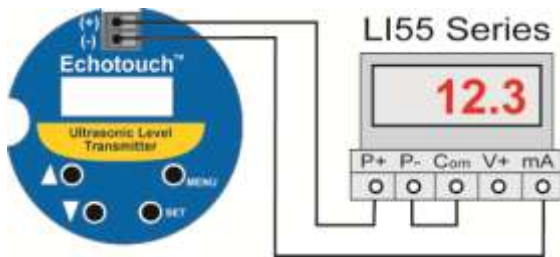

Wiring to a DataLoop LI25 Series Level Indicator without the Backlight:

Wiring to a DataLoop LI25 Series Level Indicator with the Backlight:

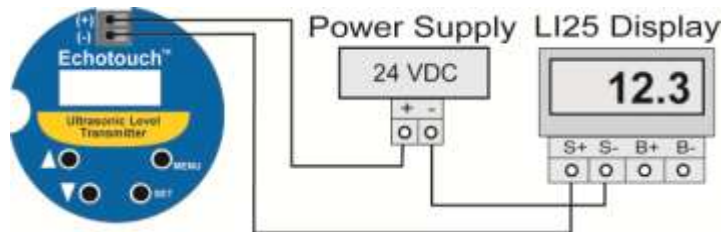

Note: Without the backlight, there will be a 2 VDC voltage drop.

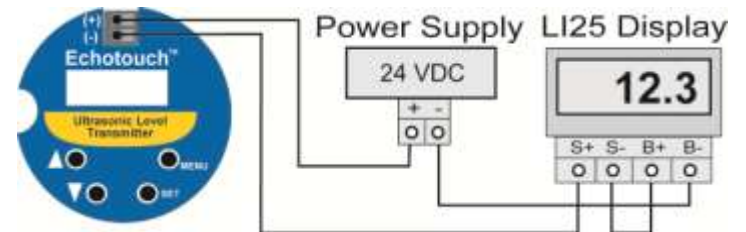

Note: the With the backlight, there will be a 5.7 VDC voltage drop.

Wiring to the Commander LI90 Series Multi-Tank Level Controller:

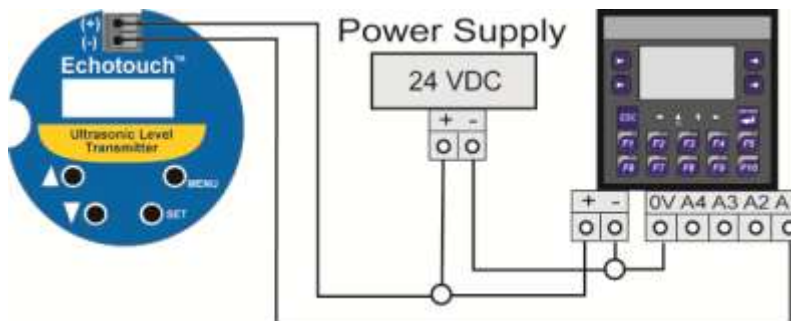

The LU20-50_1-IS requires 12-32 VDC power with at least 25mA supply in order to operate. The follow provides an overview of wiring the LU20-50_1-IS to various devices. Please note that a barrier must be installed between the Echotouch and the device and the barrier must be located within the nonhazardous location.

HAZARDOUS SYSTEM DIAGRAM

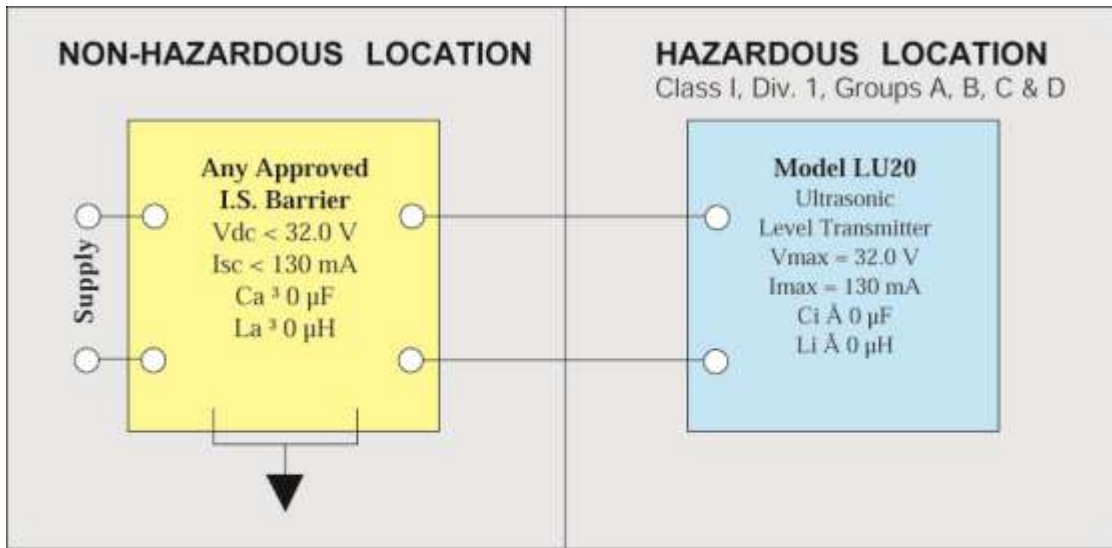

Control drawing for the LU20-5001-IS ultrasonic level transmitter approved under the entity concept as an I.S. apparatus

**Control Drawing: LU20CD
Rev. 7-24-97**

WIRING TO THE DATAPoint LC52 SERIES LEVEL CONTROLLER

JWA mode (Factory Setting)

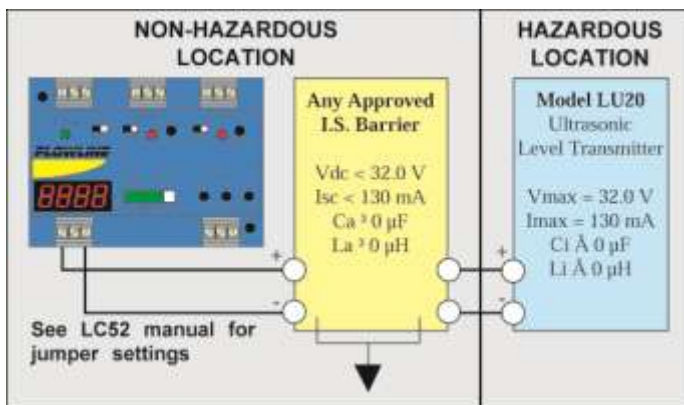

WIRING TO A GENERIC PLC

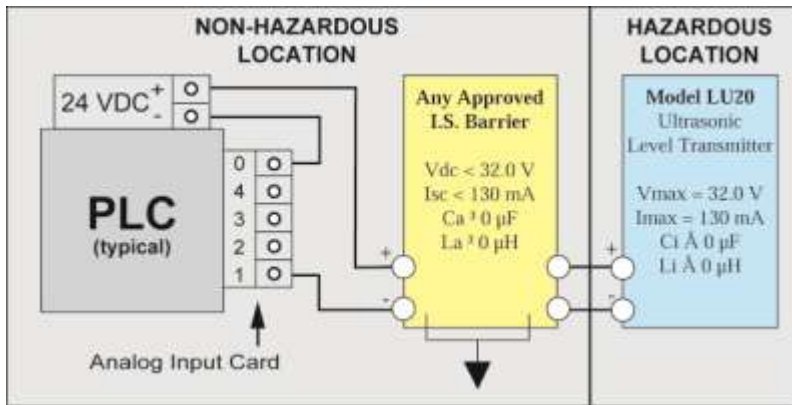

WIRING TO THE COMMANDER LI90 SERIES MULTI-TANK LEVEL CONTROLLER

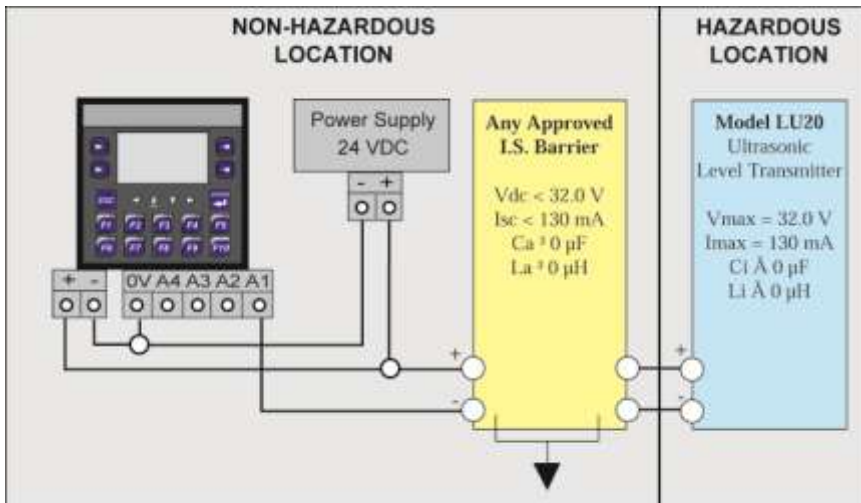

WIRING TO THE DATAVIEW LI55 SERIES LEVEL CONTROLLER

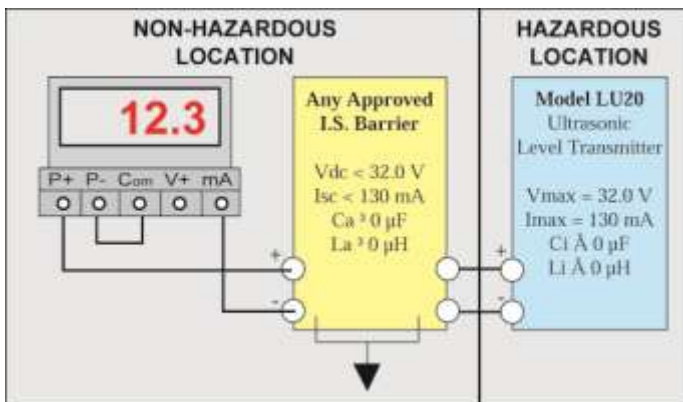

WIRING TO A GENERIC LOOP POWERED DISPLAY

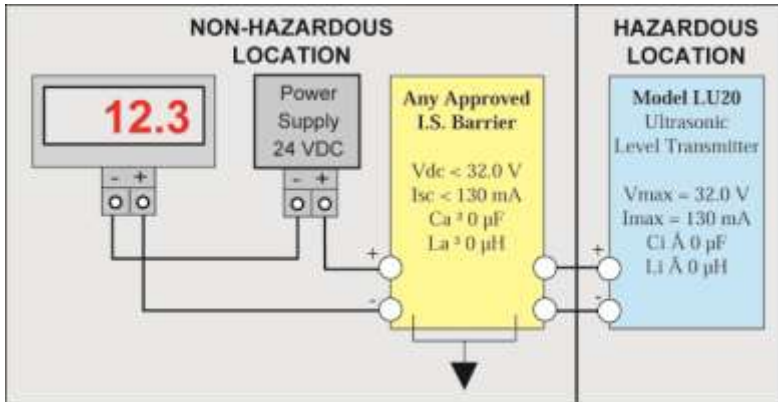

WIRING TO A DATALOOP LI25 SERIES LEVEL INDICATOR WITHOUT THE BACKLIGHT
 (Note: the LI25 series without backlight will have an added 2 VDC voltage drop)

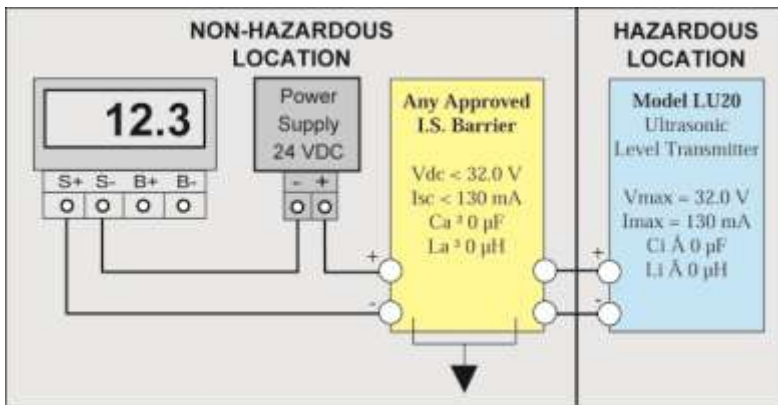

WIRING TO A DATALOOP LI25 SERIES LEVEL INDICATOR WITH THE BACKLIGHT
 (Note: the LI25 series with backlight will have an added 5.7 VDC voltage drop)

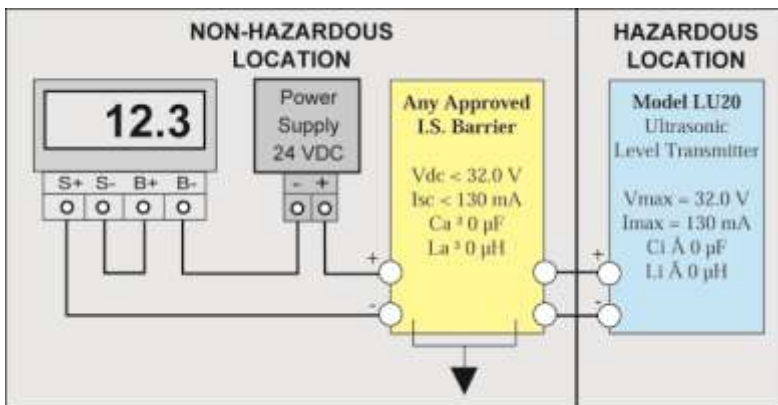

The Echotouch[®] should always be mounted perpendicular to the liquid. Make sure that the fitting and transmitter threads are not damaged or worn. Always hand-tighten the transmitter within the fitting. Perform an installed leak test under normal process conditions prior to system start up.

MOUNTING GUIDE

1. Do not mount the sensor at an angle.
2. Liquid should never enter the dead band.
3. Use the Beam Width data to determine the closest the sensor can be to the side wall.
4. Do not mount where obstacles will intrude into sensor’s beam width.
5. Do not mount the sensor in a vacuum.
6. Avoid mounting the sensor in the center of a dome top tank.
7. In cone bottom tank, position the sensor over the deepest part of the tank.

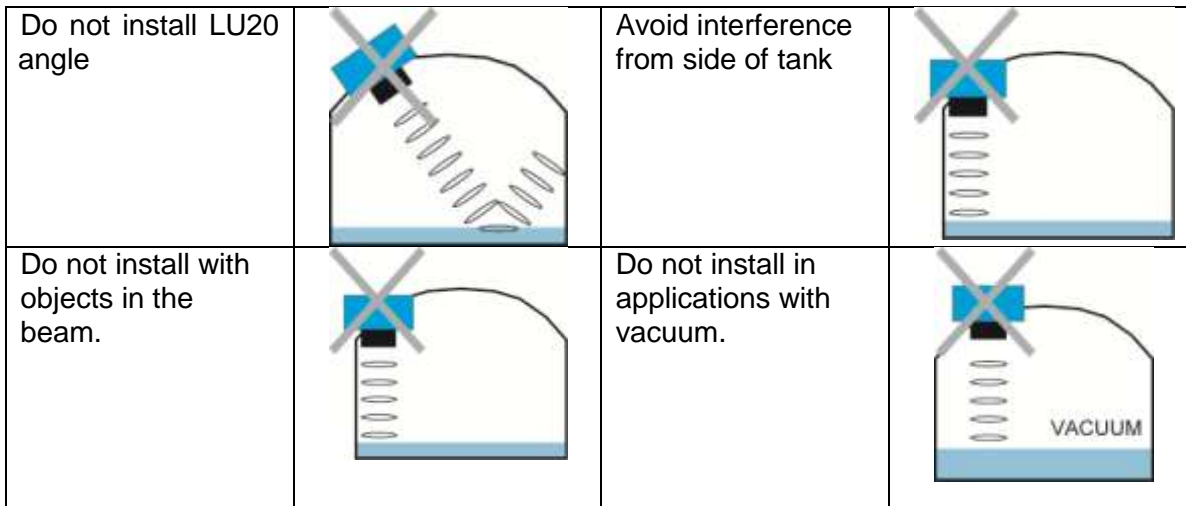

Installation in existing fittings: If the existing fitting is larger than the threads of the Echotouch, select a reducer bushing such as LM52-2400 (3” thread x 2” thread) or LM52-3800 (4” thread x 2” thread).

Beam Angle: Echotouch features an 8° beam angle. As the distance to the liquid increases, the beam will increase in size. Keep any object that can interfere with the sound pulses outside of this beam angle. Use the data provided to size the footprint of the sound pulse.

Depth	Radius	Depth	Radius	Depth	Radius
1’	1.2”	7’	6.2”	13’	11.3”
2’	2.1”	8’	7.1”	14’	12.1”
3’	2.9”	9’	7.9”	15’	13.0”
4’	3.7”	10’	8.8”	16’	13.8”
5’	4.6”	11’	9.6”	17’	14.6”
6’	5.4”	12’	10.4”	18’	15.5”

Fitting Selection: EchoTouch® is commonly installed in tank adapters, flanges, brackets or standpipes.

1. **Tank Adapter:** Select a tank adapter fitting, such as the LM52-2890 for the LU20 series.
 - a. Avoid tank adapter (thread x thread) styles and/or pipe stops forward of the installed transducer.
 - a. For larger tank adapters, it is OK to use a reducer bushing such as the LM52-2400 (3" thread x 2" thread).

2" Tank Adapter Socket x Thread



Tank Adapter Thread x Thread



Do not use thread x thread

2. **Riser:** Installations with tall, narrow risers can impede the acoustic signal.
 - a. 2" (5 cm) diameter risers should be no taller than 3" (7.6 cm). Larger diameter risers should be no taller than 12" (30.5 cm).

	Riser Specifications	
	Inner Diameter	Maximum Height
	2" (5 cm)	3" (7.6 cm)
	4" (10 cm)	8" (20 cm)
	6" (15 cm)	12" (30 cm)

Note: Do not exceed the dimensions listed above.

3. **Flange:** If installing on a flange, select a flange with a thread that is equal to the thread of the Echotouch.
 - a. When using a flange with a riser, please observe the riser dimensional information above.
4. **Side Mount Bracket:** For installations in open tanks and sumps, use the LM50 series side mount bracket.
 - a. Be aware of the 8° beam angle with the Echotouch® transmitter.
 - b. Use the Beam Width data to avoid having the sensor's beam away from the side wall.

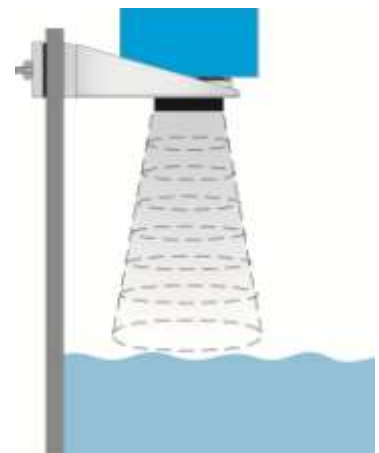

5. **Stand Pipe:** A standpipe may be used to dampen turbulence or when foam is present in the application.
- Pipe can be made of any material.
 - Select a minimum 2" ID pipe for the stand pipe.
 - A larger diameter pipe can be used.
 - Use a coupling and reducer bushing to attach the Echotouch to the pipe.
 - The pipe length should run the measurement span and the bottom of the pipe should remain submerged at all times to prevent foam from entering the pipe.
 - The pipe must be a continuous length with no joints, couplings or extensions.
 - Cut a 45° notch at the bottom of the pipe and drill a 1/4" pressure equalization hole in the dead band.
 - The vent hole must be within the dead band of the Echotouch.
 - The pumps should not drive liquid past the open end of the stand pipe which causes the liquid in the pipe to oscillate.

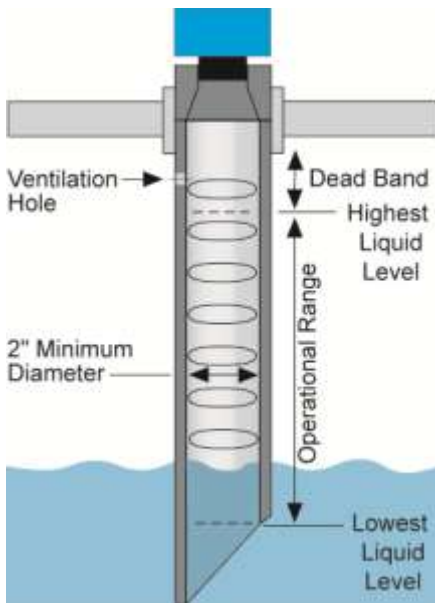

Return to Factory Setting: The LU20 is preset at time of shipment with the Factory Settings listed below. If at any time you need to return to the Factory Settings, remove power from the LU20 and wait 10 seconds. Press the [MENU] and [SET] buttons simultaneously while powering up the transmitter.



Note: If power is cycled on and off or removed for a long duration of time, the configuration will not change. The only way to return to Factory Settings is to hold both the [MENU] and [SET] buttons while applying power.

FACTORY SETTINGS

EC4	216" (548.4cm)	ON/OFF	OFF
EC20	8" (20.3cm)	MAXR	N/A
SAF1/2/3	SAF1	value	216" (548.6cm)
FAST/SLOW	FAST	MINR	N/A
ALIN	N/A	value	8" (20.3cm)

Changing Display Units: The LU20 comes preset to measure in inches (default setting). To change the display to show centimeters or to return to inches, flow the steps below. **Note:** If power is removed, the sensor will remain in the selected mode.

Change to Centimeters



1. Remove power to the LU20 and wait 10 seconds.
2. Simultaneously press [Δ] and [SET] while adding power to the transmitter.
3. The LU20 will now read in centimeters.

Change to Inches



1. Remove power to the LU20 and wait 10 seconds.
2. Simultaneously press [∇] and [SET] while adding power to the transmitter.
3. The LU20 will now read in inches.

Warning

Always install the 2" Viton gasket with the LU20-5061 and the LU20-5061-IS. The G threaded version of the Echotouch® will not seal unless the gasket is installed properly.

PROBLEM	SOLUTION
Transmitter outputs current of 0 mA	Check the wiring for an open circuit. An open circuit is the most common issue with a 0 mA signal
Transmitter jumps to a current output between 19 and 20 mA	Check the installation of the transmitter. Bad installation fittings will cause false signals near the top of the tank, which typically translates to a signal between 19 and 20 mA. Also look for interference just below the transmitter.
Transmitter outputs a current over 22 mA	Immediately check the wiring for a short circuit. The Echotouch® is current limited to 22 mA. Anything above 22 mA indicates a short circuit.
Transmitter always jumps to LOST condition	<p>A reading of LOST in the display of the LU20 indicates the transmitter is not receiving a valid return signal. If LOST appears, please check the following troubleshooting items:</p> <ol style="list-style-type: none"> 1. Beam cone interference such as the side wall, ladder, seams, rungs or pipes within the LU20's beam cone. 2. Proper installation such that the LU20 is installed level and free from interference from the installation fitting or flange. 3. Sufficient power being supplied to the LU20. The LU20-50_1 requires 12-36 VDC power with a minimum supply 25mA. The LU20-50_1-IS requires 12-32 VDC with a minimum supply of 25mA. 4. Proper Programming of the MAXR or MINR function. For best results, set the MAXR function as the distance from the bottom of the tank to the bottom of the transmitter. Also set the MINR distance above the highest level in the tank. Do not set the MINR to less than 6 inches. 5. Make sure that the transmitter is not installed at an angle. Even a 5 degree offset can reduce the signal return strength greatly.
Output of transmitter is opposite of the level of liquid	Check the EC4 & EC20 Setting. For 4mA at empty tank and 20 mA at full tank, the EC4 must be the larger value and the EC20 to smaller value. For 20mA at empty tank and 4 mA at full tank, the EC20 must be the larger value and the EC4 to smaller value.
The display on the transmitter does not match the display on the side of the tank	The display for the Echotouch® will always show the distance from the liquid surface to the bottom of the sensor (in inches or cm). The 4-20 mA output can be scaled to read in any engineering units, thus the displays will never match unless the local display is configured to read the air gap in the tank.
Sensor appears to have reset itself	<p>Check the settings for EC4 & EC20. Remember that the first value seen in EC4 & EC20 is the current distance from the sensor to the liquid.</p> <ol style="list-style-type: none"> 1. To check EC4 setting: <ol style="list-style-type: none"> a. Press MENU until EC4 appears. b. Wait until a number appears. c. Immediately press the Δ button & the EC4 setting will appear. 2. To check EC20 setting: <ol style="list-style-type: none"> a. Press MENU until EC20 appears. b. Wait until a number appears. c. Immediately press the Δ button & the EC20 setting will appear.
Display reads CM8Q or CM8O	These are actually firmware codes for the sensor. The appearance of either code indicates that the sensor is stuck in a reboot stage due to the power flickering on and off. Check that the power being supplied is consistent and does not flicker off. Also check the wire connections at the terminals.

Other Hints: Current must change with all level movement. For example, as level increases, the current output will increase. If the LU20 output is always reading 4mA or 20mA, check the input values for the LU20.

The display on the EchoTouch® will always indicate the distance from the bottom of the sensor to the surface of the liquid. As the liquid level increases, the value on the display will decrease. As the liquid level decreases, the value on the display will increase.

TESTING THE TRANSMITTER

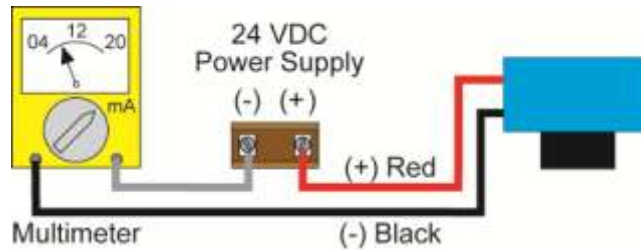

1. If installed in a classified area, remove the sensor from the hazardous location before testing.
2. Connect a multimeter in series with the black wire to read the current output.
3. Verify that the current increases (tank filling) and decreases (tank emptying) appropriately in the calibrated span.

If not, carefully observe and attempt to correlate any installation, level or application event for more specific troubleshooting direction.

User Settings

Fill out the chart below and keep as a record of your configuration.

Current Range

EC 4 =	EC20 =
--------	--------

Loop Fail-Safe (select one)

SAF1 (22 mA)	SAF2 (4mA)	SAF3 (Hold Last Value)
--------------	------------	------------------------

Operation Range

MINR =	MAXR =
--------	--------

WARRANTY

Flowline warrants to the original purchaser of its products that such products will be free from defects in material and workmanship under normal use and service in accordance with instructions furnished by Flowline for a period of two years from the date of manufacture of such products. Flowline's obligation under this warranty is solely and exclusively limited to the repair or replacement, at Flowline's option, of the products or components, which Flowline's examination determines to its satisfaction to be defective in material or workmanship within the warranty period. Flowline must be notified pursuant to the instructions below of any claim under this warranty within thirty (30) days of any claimed lack of conformity of the product. Any product repaired under this warranty will be warranted only for the remainder of the original warranty period. Any product provided as a replacement under this warranty will be warranted for the full two years from the date of manufacture.

RETURNS

Products cannot be returned to Flowline without Flowline's prior authorization. To return a product that is thought to be defective, go to flowline.com, and submit a customer return (MRA) request form and follow the instructions therein. All warranty and non-warranty product returns to Flowline must be shipped prepaid and insured. Flowline will not be responsible for any products lost or damaged in shipment.

LIMITATIONS

This warranty does not apply to products which: 1) are beyond the warranty period or are products for which the original purchaser does not follow the warranty procedures outlined above; 2) have been subjected to electrical, mechanical or chemical damage due to improper, accidental or negligent use; 3) have been modified or altered; 4) anyone other than service personnel authorized by Flowline have attempted to repair; 5) have been involved in accidents or natural disasters; or 6) are damaged during return shipment to Flowline. Flowline reserves the right to unilaterally waive this warranty and dispose of any product returned to Flowline where: 1) there is evidence of a potentially hazardous material present with the product; or 2) the product has remained unclaimed at Flowline for more than 30 days after Flowline has dutifully requested disposition. This warranty contains the sole express warranty made by Flowline in connection with its products. ALL IMPLIED WARRANTIES, INCLUDING WITHOUT LIMITATION, THE WARRANTIES OF MERCHANTABILITY AND FITNESS FOR A PARTICULAR PURPOSE, ARE EXPRESSLY DISCLAIMED. The remedies of repair or replacement as stated above are the exclusive remedies for the breach of this warranty. IN NO EVENT SHALL FLOWLINE BE LIABLE FOR ANY INCIDENTAL OR CONSEQUENTIAL DAMAGES OF ANY KIND INCLUDING PERSONAL OR REAL PROPERTY OR FOR INJURY TO ANY PERSON. THIS WARRANTY CONSTITUTES THE FINAL, COMPLETE AND EXCLUSIVE STATEMENT OF WARRANTY TERMS AND NO PERSON IS AUTHORIZED TO MAKE ANY OTHER WARRANTIES OR REPRESENTATIONS ON BEHALF OF FLOWLINE. This warranty will be interpreted pursuant to the laws of the State of California. If any portion of this warranty is held to be invalid or unenforceable for any reason, such finding will not invalidate any other provision of this warranty.

For complete product documentation, video training, and technical support, go to flowline.com. For phone support, call 562-598-3015 from 8am to 5pm PST, Mon - Fri. (Please make sure you have the Part and Serial number available.)