

Installation and Specifications

In This Chapter. . . .

- Labeling the Lamps and Pushbuttons
 - Templates for Manually Creating labels
 - Dimensions for Mounting
 - Panel Specifications
 - Power Supply Connections
 - Connecting the Configuration Cable
 - Selecting a Communications Cable
 - Communications Cable Details
-

Labeling the Lamps and Pushbuttons

Labeling the Lamps and Pushbuttons

Labeling the OP-406 panel is a relatively simple process that involves removing the bezel and sliding a label transparency into a pocket in the panel overlay. The transparent film can be purchased from almost any office supply store in standard 8-1/2" x 11" sheets. It is designed to run through a copy machine or laser printer.

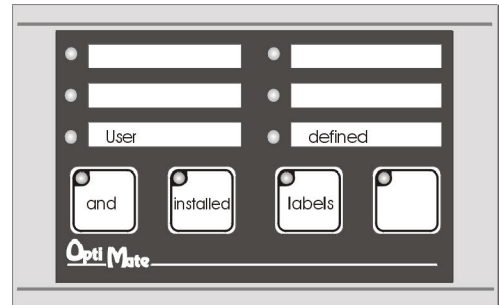

Creating the Labels

The easiest way to create labels is to use the built-in label making function of the OP-WINEDIT configuration software. This is the preferred method and is shown below. The labels can also be created manually using the template shown in the next section to help layout the transparency film. Here are some ways of manually creating labels:

- Use a computer graphics program and a laser printer to create the transparency directly, or print the labels on paper and photocopy them to a transparency sheet.
- Use press-on letters on a transparency sheet.
- Use a typewriter or lettering machine, or use press-on letters to create labels on a paper sheet, then photocopy the paper sheet onto a transparency sheet.

Creating Labels Using OP-WINEDIT

Making labels using the OP-WINEDIT configuration software is easy (see Chapter 4 for information on loading and using OP-WINEDIT). After loading OP-WINEDIT, follow these steps:

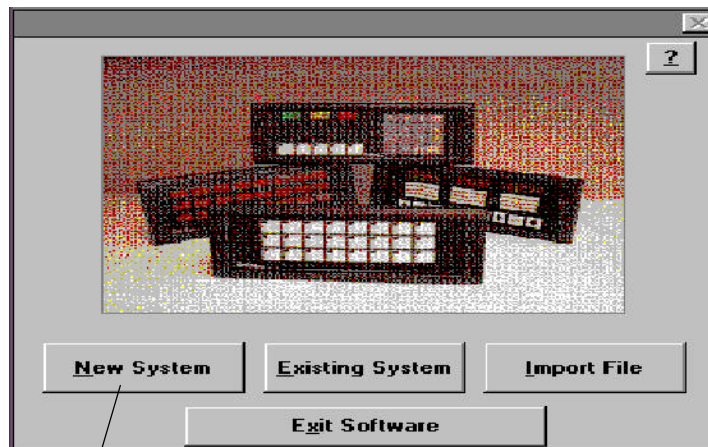

1. Open OP-WINEDIT and select **New System**.

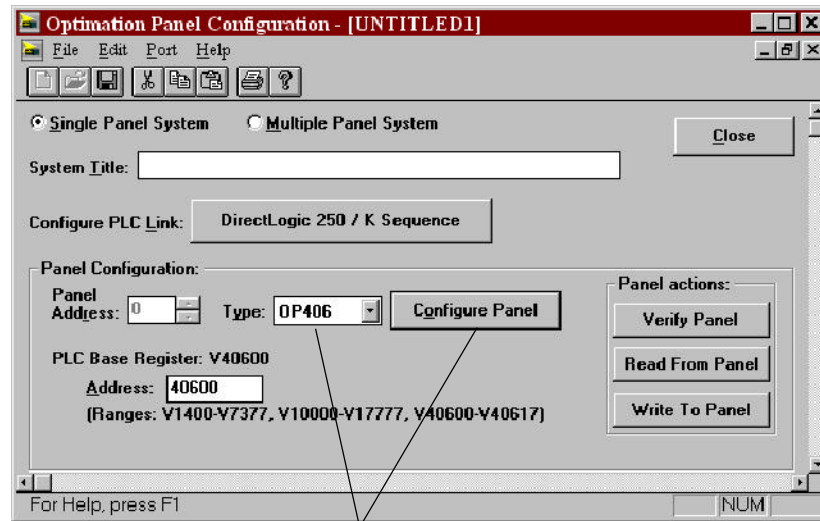

2. Select **OP-406**, and **Configure Panel**.

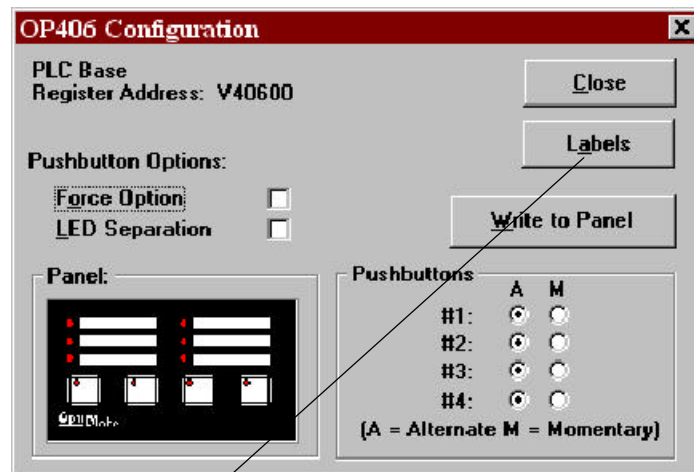

3. Select **Labels**.

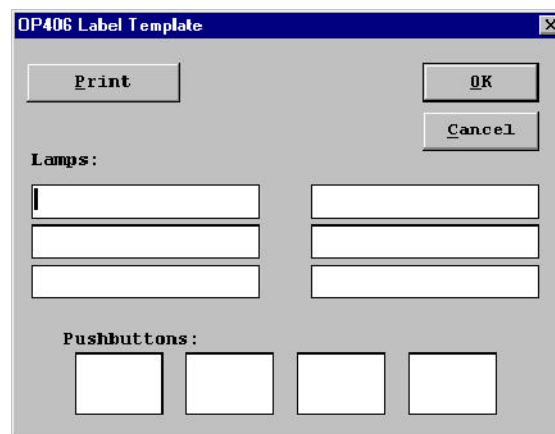

4. The OP-406 Label Template appears. Type in the label text for all indicators and pushbuttons. Press **OK** to save the labels.

5. **Print** label on transparent film.
6. Cut out the block of labels and insert them in the panel.

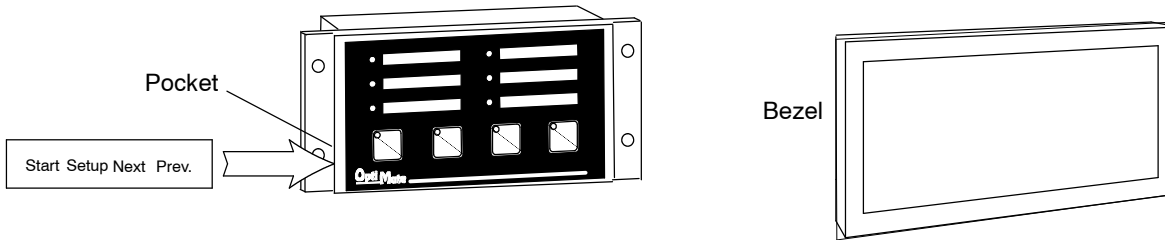
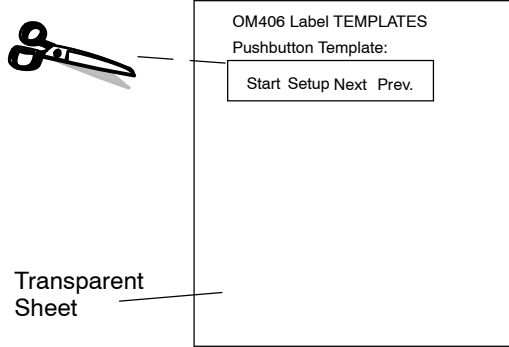
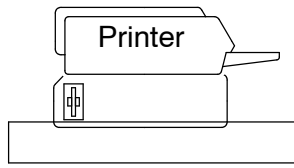

Remove the bezel from the module by unsnapping the four plastic tabs which hold the bezel to the module frame. Locate the pocket, and carefully slide the labels into place. Re-attach the bezel by snapping the bezel onto the case.

Templates for Manually Creating Labels

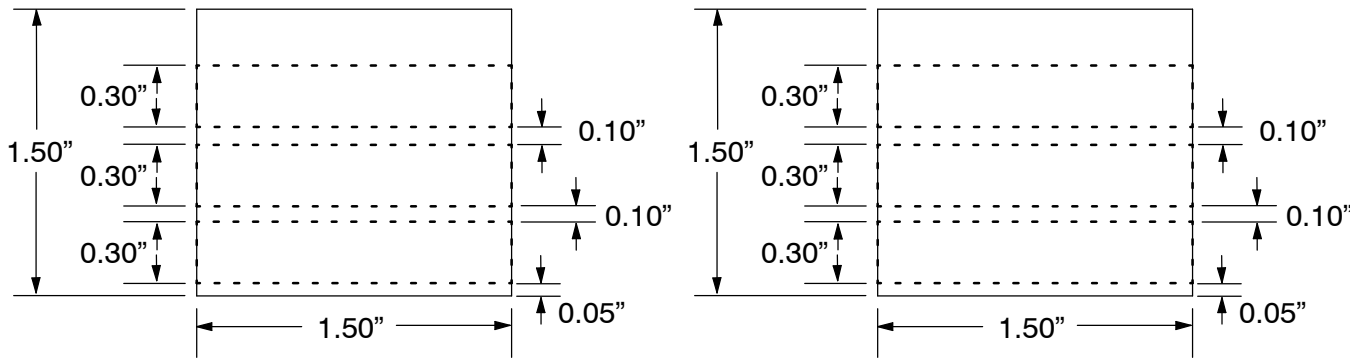

Indicator Lamp Label Inserts

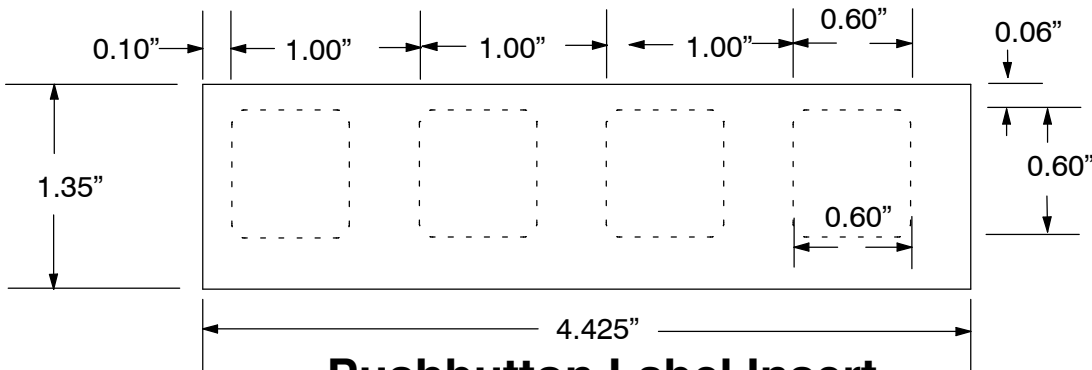

Pushbutton Label Insert

Dimensions for Mounting

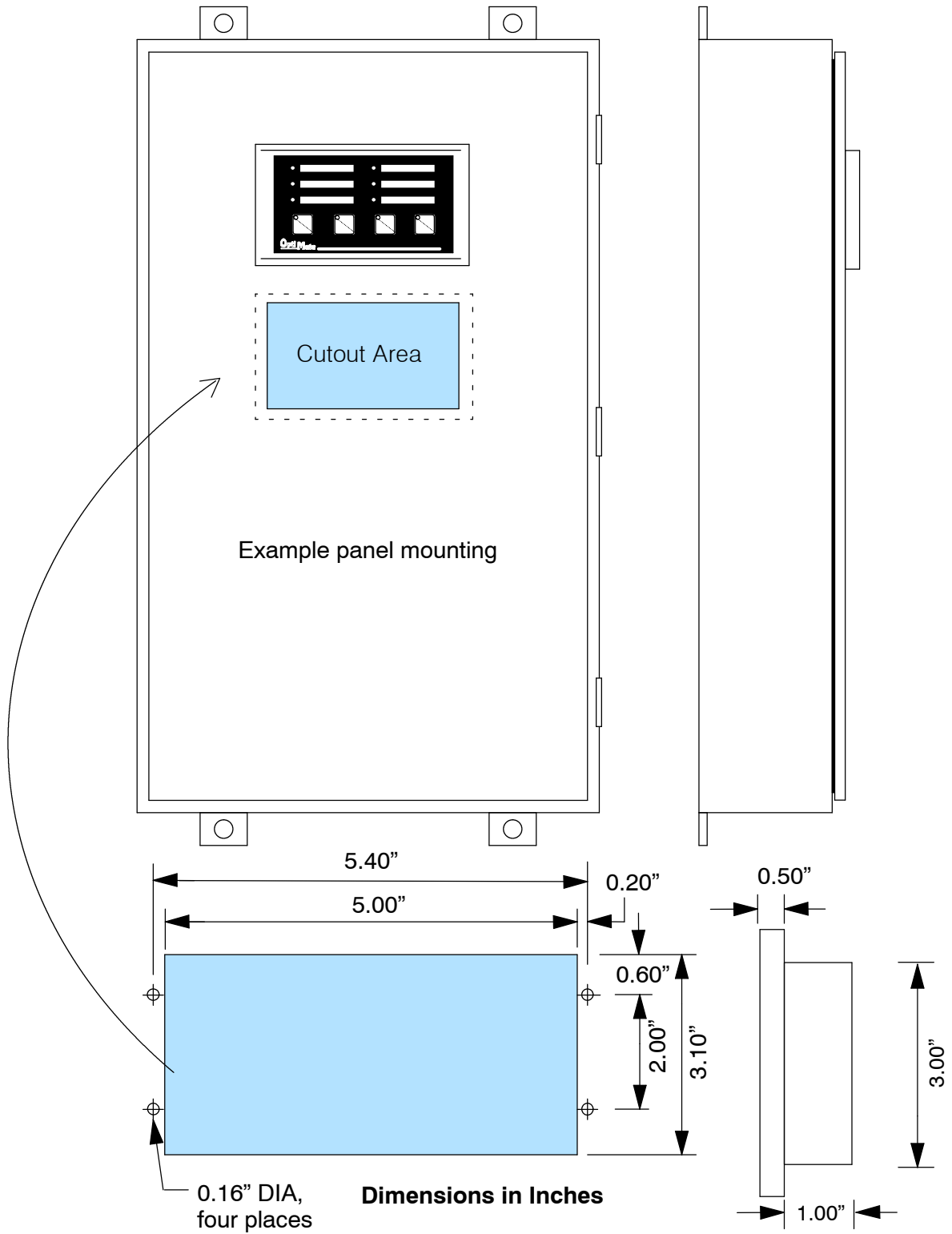

Specifications

Panel Specifications

Physical

Specifications

Weight	8 ounces
Panel Fasteners	Four 6x32 threaded studs
Pushbutton Dimensions	0.65 in. square on 1.0 in. centers
Pushbutton Life	1,000,000 switch cycles
Indicator Lamp Colors	Red
NEMA Rating	NEMA 4 (when properly installed)

Environmental

Specifications

Operating Temperature	0° to 50° C
Storage Temperature	-20° to 70° C
Operating Humidity	95% (non-condensing)
Air Composition	No corrosive gases permitted

Operating

Specifications

Power Consumption	0.25W @ 5 VDC (Power On surge of 0.35A for 1 ms max.)
Power Connector	Three terminal DC power plug, center negative
Power Supply	+5 VDC external power supply required for configuration on all panels; required for operation on all PLCs except DL05, DL105, DL205 and DL405.
Minimum/Maximum Supply Voltage	+5 VDC only
Diagnostics	LED Status
Communication Link	RS-232 4800 to 19200 baud 6-pin RJ12 phone jack type connector

Power Supply Connections

OP400 series panels require +5 VDC input power. An optional 5 VDC external power supply that plugs into a standard 120 VAC receptacle is available (part no. OP-PS400). This power supply (or equivalent) is required for configuring your panel. It is also required for operation **unless** you are using a DL05, DL105, DL205 or DL405 PLC; these products supply 5VDC through the communications cable. All other PLCs, including the DL305s, Allen-Bradley 5/03, 5/04 and Micrologix, require the use of an external 5VDC power supply during operation.



NOTE: Only use a 5 VDC power supply that has a **center negative** DC power jack.

Configuration: 5 VDC Power Supply Required For Configuring All 400 series panels

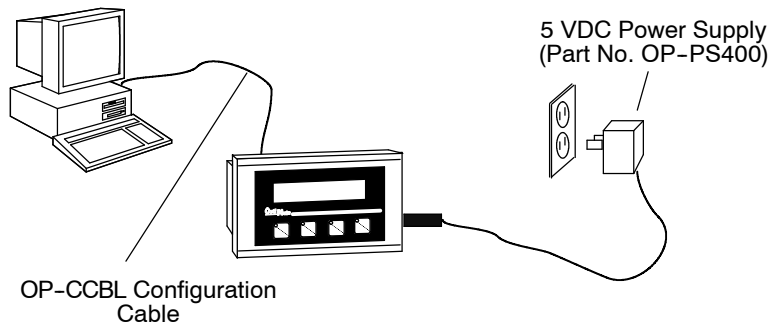

Operation Using a D3-340, D3-350, D3-330 w/DCU, Bottom Port of DL405 or Allen-Bradley CPU: 5 VDC Power Supply Required

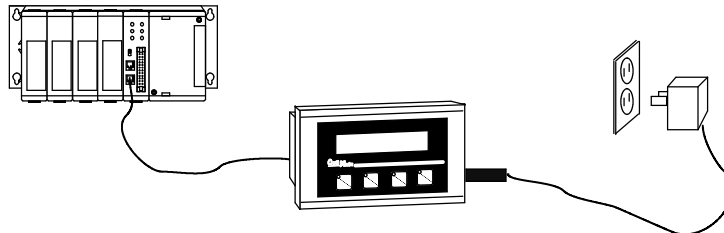

Operation Using a DL05, DL105, DL205, or Top Port of DL405 CPU: 5 VDC Power Supply Not Required

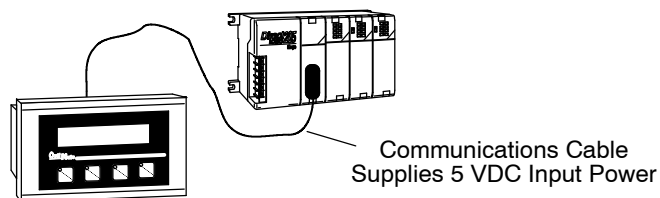

Power Supply Connections

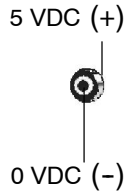

Insert power supply connector into receptacle



Connecting the Configuration Cable

Configuration Cable

You will need two cables to use your OP-panel: A configuration cable (part number OP-CCBL) and a communications cable. Connect the configuration cable between the serial port on the rear of the OP-panel and the serial port of the personal computer. The panel may then be configured using the OP-WINEDIT configuration software. The figure below shows configuration cable connectors and wiring specifications. The wiring diagram refers to the cable connectors, *not* the communication ports. This cable is disconnected after configuration.

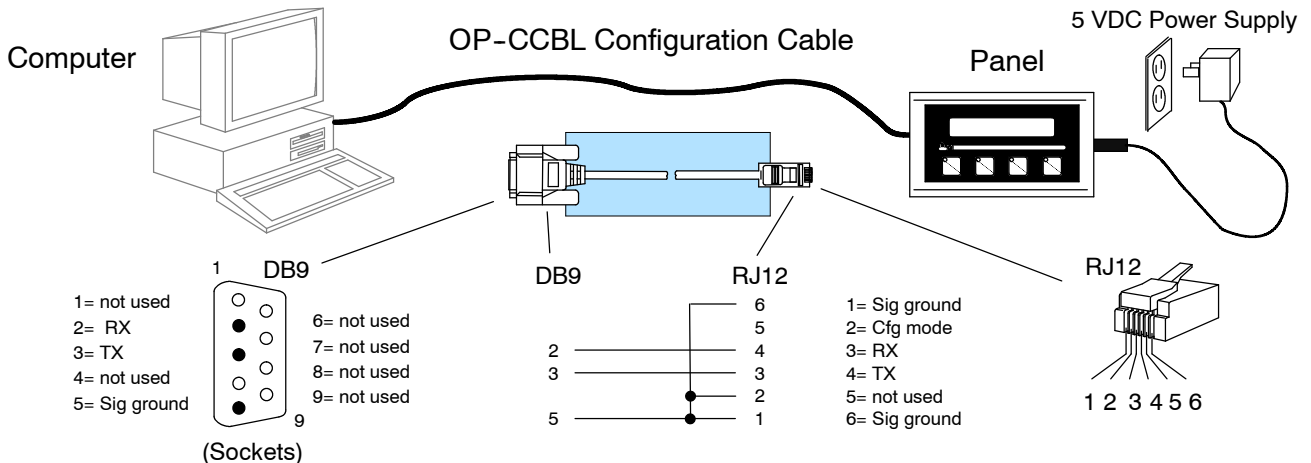

Selecting a Communications Cable

After configuration, connect the communications cable between the OP-panel and the PLC. Use the following table to select the proper communications cable.

Cables for OP400 Series OptiMate Panel-to-PLC Connections			
Family	CPU (or other device)	Port	Cable
<i>Direct</i> LOGIC™ DL05	D0-05xx	Ports 1 and 2	OP-2CBL-2
<i>Direct</i> LOGIC™ DL105	F1-130	Only one	OP-2CBL-2
<i>Direct</i> LOGIC™ DL205	D2-230	Only one	OP-2CBL-2
	D2-240	Top port	OP-2CBL-2
		Bottom port	OP-2CBL-2
	D2-250	Top port	OP-2CBL-2
		Bottom port	* (see note below)
D2-DCM (module)	Only port	* (see note below)	
<i>Direct</i> LOGIC™ DL305	D3-330	Requires DCU	* (see note below)
	D3-330P	Requires DCU	* (see note below)
	D3-340	Top port	OP-3CBL-1
		Bottom port	OP-3CBL-1
	D3-350	Top port	OP-2CBL-2
Bottom port		* (see note below)	
<i>Direct</i> LOGIC™ DL405	D4-430	Top port (15-pin)	OP-4CBL-3
		Bottom port (25-pin)	* (see note below)
	D4-440	Top port	OP-4CBL-3
		Bottom port	* (see note below)
	D4-450	Phone Jack	OP-2CBL-2
		Top port (15-pin)	OP-4CBL-3
		Bottom port (25-pin)	* (see note below)
	D4-DCM (module)	Only port	* (see note below)
	Slice I/O panels	Only one	OP-4CBL-3
TI305™ / SIMATIC® TI305™	325-07, PPX:325-07	Requires DCU	* (see note below)
	330-37, PPX:330-37	Requires DCU	* (see note below)
	325S-07 (or 325 w/ Stage Kt)	Requires DCU	* (see note below)
	330S-37, PPX:330S-37	Requires DCU	* (see note below)
	335-37, PPX:335-37	Phone Jacks	OP-3CBL-1
If DCU is used		* (see note below)	
TI405™ / SIMATIC® TI405™	425-CPU, PPX:425-CPU	Only one	OP-4CBL-3
	PPX:430-CPU	Top port (15-pin)	OP-4CBL-3
		Bottom port (25-pin)	* (see note below)
	435-CPU, PPX:435-CPU	Top port (15-pin)	OP-4CBL-3
		Bottom port (25-pin)	* (see note below)
Smart Slice™ I/O panels	Only one	OP-4CBL-3	
Allen-Bradley™ SLC 500	5/03, 5/04	Bottom port	OP-ACBL-3
Allen-Bradley	MicroLogix	Only one	OP-ACBL-4

* **Note:** Pre-assembled cables for connecting to these ports are not supplied by **Automationdirect.com**; however, you can use the cable pinout diagrams in the following section to make your own cables.

Communications Cable Details

The drawings on this page are for cables which **are** supplied by **Automationdirect.com**. Use this page if you need to make your own cables. We recommend using 22 AWG shielded cable.

OP400 Series Communications Cables

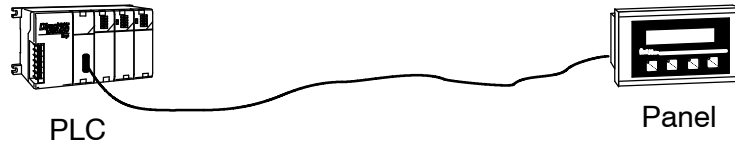

OP-2CBL-2 (DL05, DL105, DL205, D3-350, D4-450)

- 1= Sig ground
- 2= 5 VDC
- 3= RX
- 4= TX
- 5= not used
- 6= Sig ground

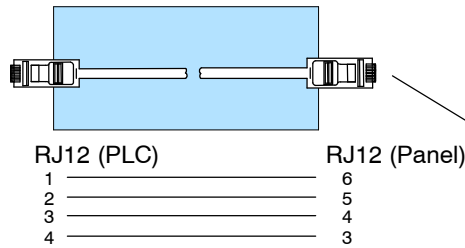
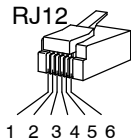

Panel Connection

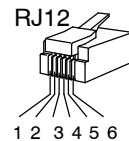

OP-3CBL-1 (D3-340)

- 1= RX
- 2= TX
- 3= not used
- 4= Sig ground

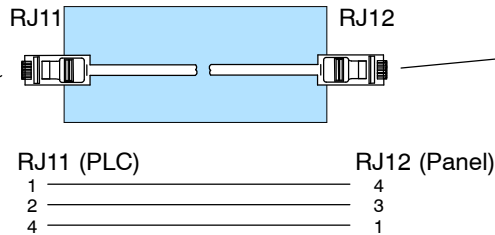
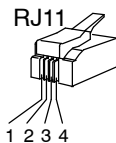

- 1= Sig ground
- 2= not used
- 3= RX
- 4= TX
- 5= 5 VDC
- 6= Sig ground

OP-4CBL-3 (DL405)

- 8= not used
- 7= not used
- 6= not used
- 5= not used
- 4= Sig ground
- 3= RX
- 2= TX
- 1= not used

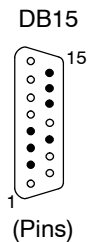

- 15= Sig ground
- 14= Sig ground
- 13= Sig ground
- 12= not used
- 11= 5 VDC
- 10= not used
- 9= not used

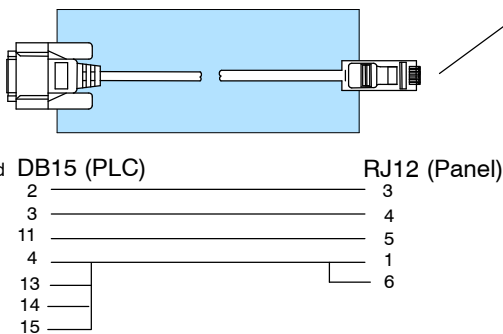

OP-ACBL-3 (Allen-Bradley)

- 1= not used
- 2= RX
- 3= TX
- 4= not used
- 5= Sig ground

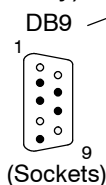

- 6= not used
- 7= RTS
- 8= CTS
- 9= not used

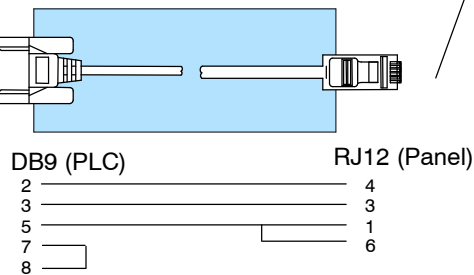

The drawings on this page are for cables which **are not** supplied by **Automationdirect.com**. Use the drawings to make your own cable. We recommend using a 22 AWG or larger shielded cable.

OP400 Series Communications Cables (continued)



Make this cable for use with D2-250 15-pin bottom port.

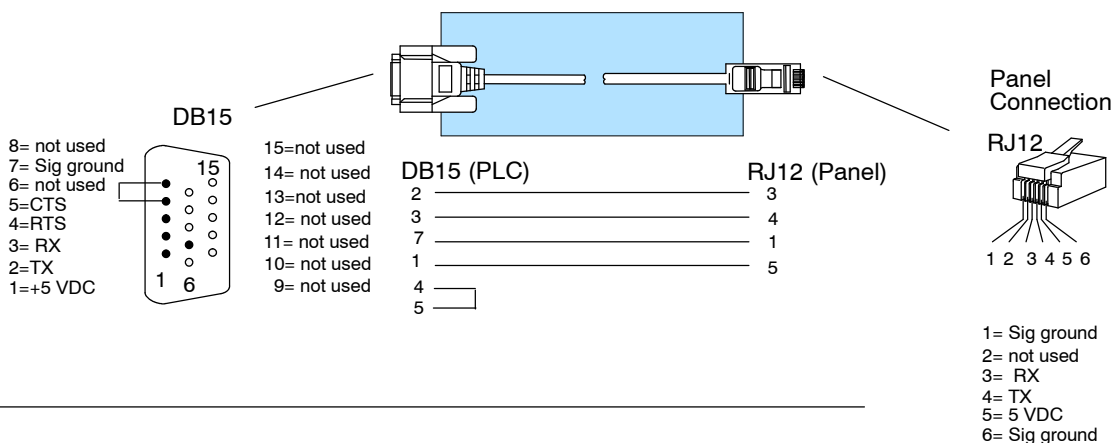

Make this cable for use with D3-330 w/DCU, D3-350, DL405 bottom ports, and all DCM modules (25-pin ports).

