

PROTOS^x

PX-TCP2 – Modbus TCP Bus Coupler with 2 RJ45 Ports

The PX-TCP2 Modbus TCP Bus Coupler server allows connection of up to 64 terminals and communicates in a Modbus TCP network using high-level Modbus commands and supports 512 bytes input data and 512 bytes output data. The PX-TCP2 consists of two RJ45 Ethernet 10/100 Base T ports for connection to a Modbus client. Use with the Protos X™ I/O System.

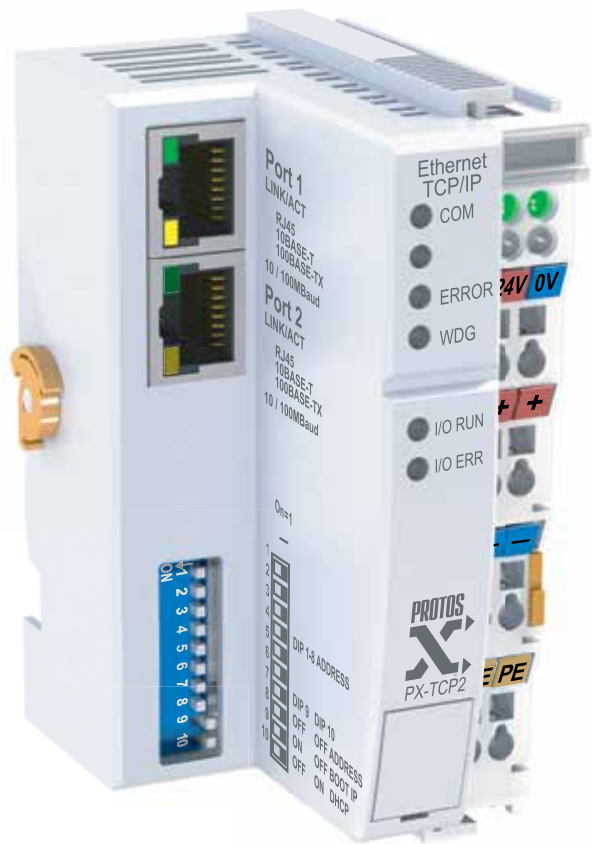

Protos X™ is a trademark of Automationdirect.com Incorporated

Sales 800-633-0405

PX-TCP2 I/O Bus Specifications		
Supply Power for I/O Bus	24VDC (-15%/+20%)	
Input Current from Power Supply	70mA + (total I/O bus current) / 4	
Recommended Fuse	10A Max	
I/O Bus Current Supply	1750mA Max	
Number of Bus Terminals Supported	64 per assembly (based on power budget)	
Number of Discrete Inputs/Outputs	512 Inputs and 512 Outputs	
Number of Analog Inputs/Outputs	128 total	
Maximum Number of Data Bytes*	512 Input Bytes and 512 Output Bytes	
PX-TCP2 Terminal Power Bus Specifications		
Supply Power for Terminal Bus	24 VAC/VDC	
Maximum Current	10A	
Number of Power Contacts	3 (+24 VAC/VDC, 0V, PE)	
PX-TCP2 Modbus Port Specifications		
Configuration	Dip switches and PX-CFGSW software	
Protocol	Modbus TCP	
Data Transfer Rates	10/100 Mbaud	
Maximum Cable Length	100m between Master and Coupler to Coupler	
Connection Type	Ethernet, 2 x RJ45 (2 Channel Switch)	
Recommended Cable	Shielded, Twisted Pair, Cat5e	
PX-TCP2 General Specs		
Operating Temp	32° to 131°F (0° to 55°C)	
Storage Temp	13° to 185°F (-25° to 85°C)	
Relative Humidity	5% to 95%, non-condensing	
Environment Air	No corrosive gases permitted	
Mounting/Orientation Restrictions	35mm DIN rail/None	
Vibration	conforms to EN 60068-2-6	
Shock	conforms to EN 60068-2-27	
Noise Immunity	conforms to EN 61000-6-2	
Protection Class	IP20	
Weight	170g	
Dimensions (WxHxD)	51 x 100 x 66mm (2.01 x 3.94 x 2.61 in)	
Agency Approvals	UL File No. E157382, CE	
LED Status	On	Off
Green Power LED (left): Bus Coupler	Bus Coupler Power ON	No Bus Coupler Power
Green Power LED (right): Terminal Bus	Terminal Bus Power ON	No Terminal Bus Power
Green Ethernet LED : COM	On/Flashing: Receiving Data	No data being received
Red Ethernet LED: ERROR	Flashing: waiting for IP address if set to DHCP or BootP.	No Error
Green Ethernet LED : WDG	Watchdog is Active	Watchdog error if no data transmitted within the set WD time. Reset using PX-CFGSW, power cycle, or using ladder logic. See PX-USER-M manual.
Green LED: I/O RUN	I/O Bus Data Active (On or Flashing)	No I/O Bus Activity
Red LED: I/O ERR	I/O Bus Error, blinking Code. See PX-CFGSW Help file or PX-USER-M manual for codes.	No I/O Bus Error

*Number of Terminals cannot exceed 512 input bytes and 512 output bytes.

www.automationdirect.com

OVERVIEW

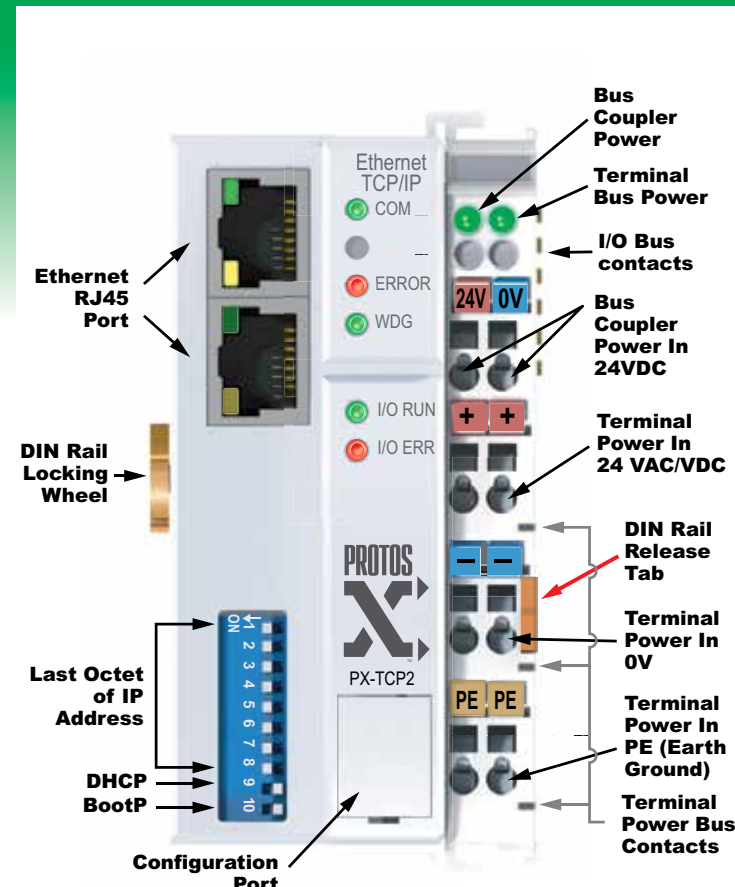

Configuration Port
Requires cable PX-USB-232, with a USB 2.0 type A connector for the PC and a 4-pin custom micro connector for the bus coupler. Works with PX-CFGSW software.



IP Address Setting
When setting the IP Address the first three octets of the address are set using PX-CFGSW software. The fourth octet is set using the dipswitches. See PX-USER-M for full details.

DCHP/BootP
Used to select the type of address assignment. If both DIP switches are off, assignment is by DIP Switches (1 through 8).

WIRING DIAGRAMS

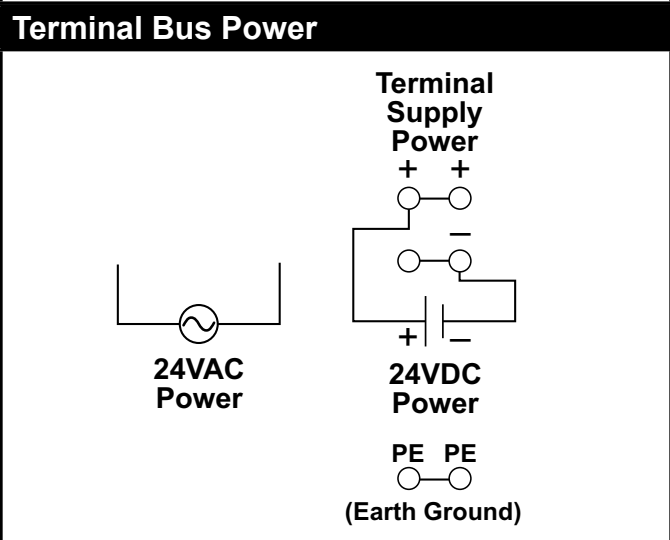
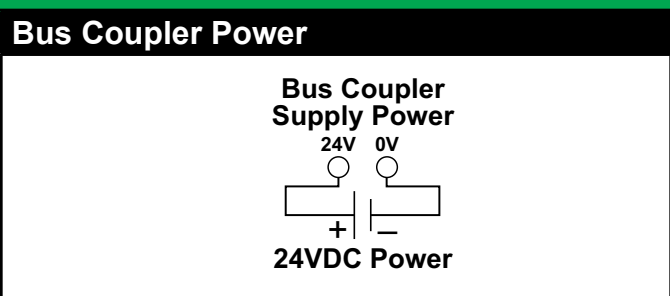

PX-TCP2 Ethernet Connection

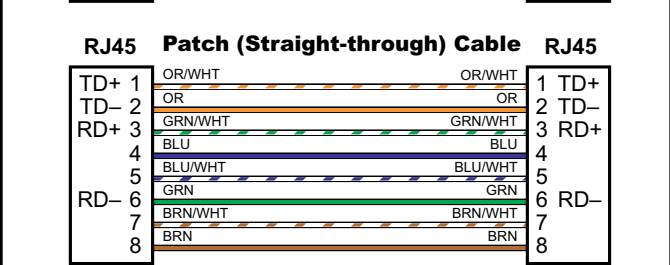
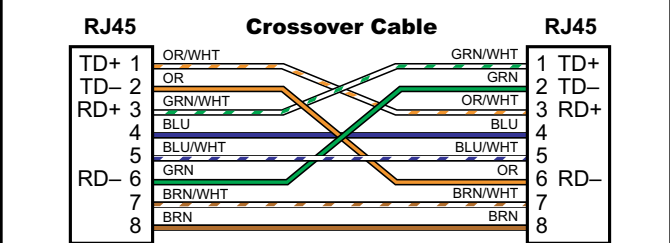
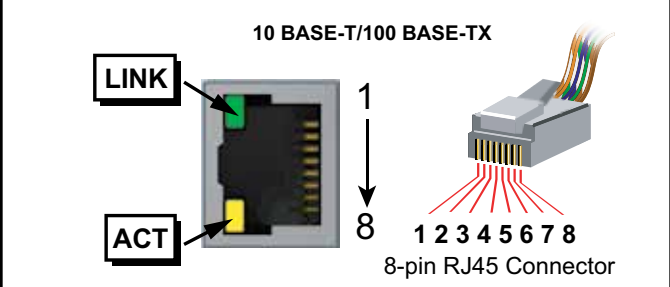

Cat5e cable recommended.
See PX-USER-M manual for complete details.

LED Status		
Green LINK LED	ON = Connection Good	Flashing = Comm Active
Yellow ACT LED	ON = 100 Mbaud	OFF = 10 Mbaud

Tech Support 770-844-4200

www.automationdirect.com

SYSTEM CONSIDERATIONS

The PX-TCP2 performs as a Modbus TCP server in a Modbus network. Communication to the client is via an RJ45 Ethernet port. A second port allows expansion of up to 20 total PX-TCP2 Couplers in a network. The maximum distance from a client to a PX-TCP2, and between each additional PX-TCP2, is 330 feet (100 meters) for each segment, using 24 AWG shielded, twisted pair Cat5e cable. It is highly recommended that a dedicated network be used for the Protos X system.

The PX-TCP1 Bus Coupler supports up to 64 terminals per assembly. It is *not compatible with Bus Expansion Couplers*. A minimal assembly consists of a **PX-TCP2 Bus Coupler, I/O Terminals and a Bus End Terminal (PX-901)**.

The PX-TCP2 automatically assigns Modbus addresses for inputs and outputs to the image register. The maximum number of data is 512 bytes of input data and 512 bytes of output data, with up to 512 inputs, 512 outputs, and 128 analog inputs or outputs.

An **I/O Bus**, powered through the Bus Coupler, provides data communication across the terminal assembly via six contacts located on the side walls of the terminals. This bus also supplies low voltage power to the I/O terminals. The I/O Bus supply is rated at a maximum of 1750mA, which must be taken into consideration when planning an assembly. Each terminal has an I/O bus current consumption listing which can be used to determine the total I/O bus current. The maximum I/O bus current of the coupler must not be exceeded as there is no internal overcurrent protection.

A **Terminal Power Bus** provides power for the I/O terminals via three contacts; 24V, 0V and PE. A power source of 24VAC or 24VDC must be connected to the bus Coupler from an external supply. The PE Bus is available for terminals

that support PE connectivity.

A variety of Power Terminals are available for isolating, changing or supplying power to the I/O terminals.

For isolating voltages across the Terminal Power Bus a **Power Separation Terminal (PX-908)** is used. This terminal separates the Terminal Power contacts but passes I/O Bus communication.

If additional 24VDC supply is required for terminal wiring, eight points of 24VDC power can be distributed from the Terminal Power Bus using a **Power Distribution Terminal (PX-949)**. This terminal must be mounted to the right of a terminal that passes 24VDC on the power bus. Both I/O Bus communication and terminal bus power are passed through to adjoining terminals.

To connect field power to the Terminal Power Bus, or to change from one voltage to another, **Power Feed Terminals (PX-940 & PX-970)** are used. Power Feed Terminals are available in 24VDC or 120-230VAC, and provide power to I/O Terminals located to the right of the Power Feed Terminal. This terminal passes I/O Bus communication. Power Terminals do not consume any addresses.

It is important to stay within the following three specifications:

1. Do not exceed the total number of 64 Terminals allowed per Assembly.
2. Do not exceed the total number of 512 Input Bytes and 512 Output Bytes.
3. Do not exceed the Coupler I/O Bus Power Budget of 1750mA as there is no internal current protection.

For complete system assembly instructions see the PX-USER-M Manual.

MOUNTING

For system assembly, first attach a bus coupler by snapping onto 35mm DIN rail and securing into position using the DIN rail locking wheel located on the left side of the coupler. To add a bus terminal, insert unit onto right side of bus coupler using the tongue and groove at the top and bottom of the unit, pressing gently until it snaps onto the DIN rail. A proper connection cannot be made by sliding the units together on the DIN rail. When correctly installed, no significant gap can be seen between the attached units. Bus connection is made through the six slide contacts located on the upper right side of the units. Add up to 64 bus terminals per bus coupler, including a bus end terminal.

IMPORTANT: For complete assembly instructions and compatibility between terminals see the PX-USER-M manual available for free download at www.automationdirect.com.

Insert unit using tongue and groove molded guide and press gently until it becomes firmly seated on DIN rail.

Where applicable, rotate Locking Wheel to lock Bus Coupler

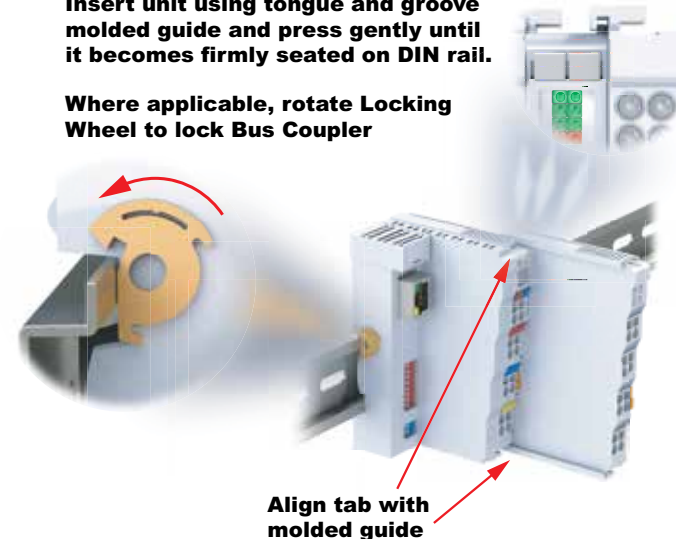

REMOVAL

A locking mechanism prevents individual units from being pulled off. For bus terminal removal, pull the orange DIN rail release tab firmly to unlatch the unit from the rail. If attached to other terminal units, slide unit forward until released. For bus couplers, release the DIN rail locking wheel, then pull firmly on DIN rail release tab.

Where applicable, rotate Locking Wheel to unlock Bus Coupler

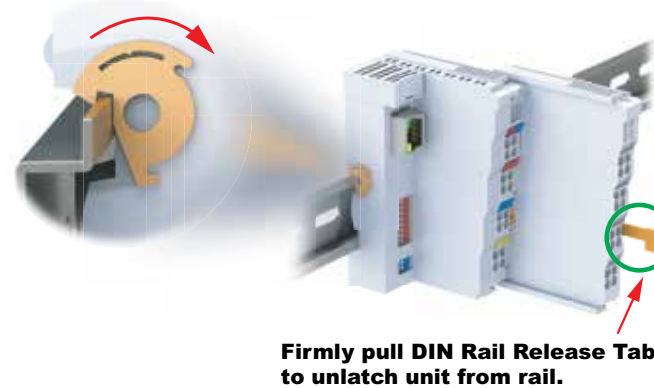

HOT SWAP NOT PERMITTED

Always remove power from the system before inserting or removing bus terminals or couplers as failure to do so could cause malfunction or damage to the terminals, couplers or other connected devices.

SAFETY

To minimize the risk of potential safety problems, you should follow all applicable local and national codes that regulate the installation and operation of your equipment. These codes vary from area to area and it is your responsibility to determine which codes should be followed, and to verify that the equipment, installation, and operation are in compliance with the latest revision of these codes.

Equipment damage or serious injury to personnel can result from the failure to follow all applicable codes and standards. We do not guarantee the products described in this publication are suitable for your particular application, nor do we assume any responsibility for your product design, installation, or operation.

If you have any questions concerning the installation or operation of this equipment, or if you need additional information, please call Technical Support at 770-844-4200. This publication is based on information that was available at the time it was printed. At AutomationDirect.com® we constantly strive to improve our products and services, so we reserve the right to make changes to the products and/or publications at any time without notice and without any obligation. This publication may also discuss features that may not be available in certain revisions of the product.

MODBUS FEATURES

The PX-TCP2 Bus Coupler functions as a server in a Modbus TCP network. For complete details see the PX-USER-M manual.

WIRING CONNECTION

Wire connection is made through a spring clamp style terminal. This terminal is designed for a single-conductor solid or stranded wire. Wire connection is made by firmly pushing the screwdriver into the screwdriver slot, inserting the wire into the wire slot and removing the screwdriver, locking the wire into position.

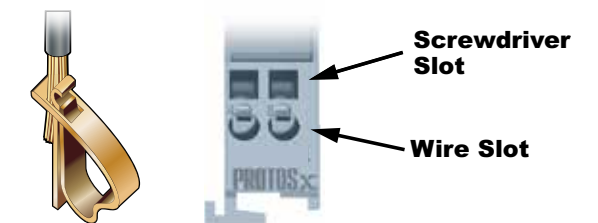

Wiring Specifications

Connection Type	Spring Clamp Terminals
Wire Gauge / Wire Cross Section	28-14 AWG / 0.08 - 2.5mm ²
Screw Driver Width	Use screwdriver width 2.5mm (0.10) such as our TW-SD-MSL-2
Wire Stripping Length	8mm

Document Name	Edition/Revision	Date
PX-TCP2-DS	1st ED.	9/15/2014

Copyright 2014, AutomationDirect.com Incorporated/All Rights Reserved Worldwide.

