

# Inverter Mounting and Installation



## 2

---

In This Chapter....	page
— Orientation to Inverter Features .....	2
— Basic System Description .....	5
— Step-by-Step Basic Installation.....	6
— Powerup Test .....	19
— Using the Front Panel Keypad .....	21

---

# Orientation to Inverter Features

## Unpacking and Inspection

Please take a few moments to unpack your new SJ100 inverter and perform these steps:

1. Look for any damage that may have occurred during shipping.
2. Verify the contents of the box include:
  - a. One SJ100 inverter
  - b. One Instruction Manual with self-adhesive label for the inverter
  - c. One SJ100 Quick Reference Guide
  - d. One packet of desiccant—discard (not for human consumption)
3. Inspect the specifications label on the side of the inverter. Make sure it matches the product part number you ordered.

## Main Physical Features

The SJ100 Series inverters vary in size according to the current output rating and motor size for each model number. All feature the same basic keypad and connector interface for consistent ease of use. The inverter construction has a heat sink at the back of the housing. The larger models include a fan(s) to enhance heat sink performance. The mounting holes are pre-drilled in the heat sink for your convenience. Never touch the heat sink during or just after operation; it can be very hot.

The electronics housing and front panel are built onto the front of the heat sink. The front panel has three levels of physical access designed for convenience and safety:

- **First-level access** – for basic use of inverter and editing parameters (power ON)
- **Second-level access** – for editing parameters and wiring control signals (power ON)
- **Third-level access** – for wiring the inverter power supply or motor (power OFF)

1. **First-level Access** - View the unit just as it came from the box as shown. The four-digit display can show a variety of performance parameters. LEDs indicate whether the display units are Hertz or Amperes. Other LEDs indicate Power (external), and Run/Stop Mode and Program/Monitor Mode status. Membrane keys Run and Stop/Reset, and a Min/Max frequency control knob control motor operation. These controls and indicators are usually the only ones needed after the inverter installation is complete. You can also access the modular jack for connecting a programming or monitoring device such as a PC (see Chapter 3). And, you can access the two chassis GND screws on the metal tab at the bottom of the inverter.



2. **Second-level access** - Locate the lift tab at the right lower corner of the front panel near the safety warning message. Lift the corner to swing the half-door around to the left. This exposes four more control buttons and some connectors.

The FUNC., ▲, ▼, and STR keys allow an operator to access and change the inverter's functions and parameter values. The two 8-position connectors provide the interface for logic-level control signals. These signals are generally low-voltage in nature and are appropriate for second-level access.



Inverter Mounting and Installation

Locate the label sheet that came with the manual. This is a good moment to apply the self-sticking labels as shown below. Adhere the larger label for monitor codes and basic functions to the rear of the half-door panel. Then adhere the remaining trip code label to the area beside the connectors. Be careful not to cover the screw access on models like the one shown.

MONITOR			
P01	Output frequency	P08	TRIP
P02	Output current	P09	TRIP history
BASIC FUNCTION			
F01	Output frequency	R01	Frequency destination
F02	Acceleration time	R02	Run command destination
F03	Deceleration time	R03	Base frequency
F04	Running direction	R04	Maximum frequency
For the other description of Monitor/Setting, see the manual.			
USER SETTING			

TRIP	
E01	Overcurrent (Const.)
E02	Overcurrent (Decel.)
E03	Overcurrent (Accel.)
E05	Overload
E07	Overvoltage
E09	Undervoltage
E14	Ground fault
E21	Thermal TRIP

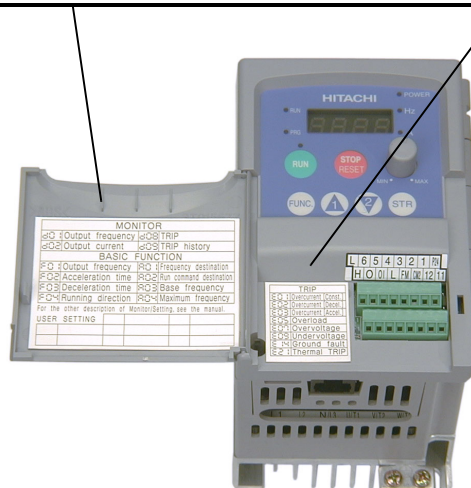

- 3. Third-level access** - First, ensure no power source of any kind is connected to the inverter. If power has been connected, wait five minutes after powerdown and verify the Power LED is OFF to proceed. Then locate the recessed retention screw on the left side main front panel (it is along the left hinge area on some models, or behind the first access door on others). Use a small screwdriver (Regular or Phillips) to loosen the screw. Swing the door around to the right to reveal the internal components of the drive. The two-level tiered 12-position terminal block accepts wires for the power input and wires to the motor.

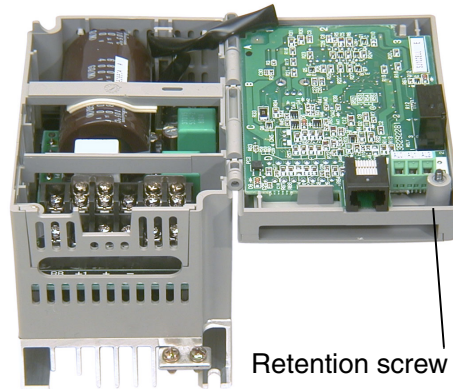

Notice the housing partition that lifts out to allow full access to the terminals for wiring as shown. Never operate the inverter drive with the partition removed or the full access door opened.

The alarm circuit connections are accessible on the 3-position connector near the modular connector on the rear of the main panel door. The nearby relay provides both normally-open and normally-closed logic for interface to an external alarm. The alarm circuit may carry hazardous live voltages even when the main power to the inverter is OFF. So, never directly touch any terminal or circuit component. A notch in the removable partition serves as the exit path for alarm circuit wiring.

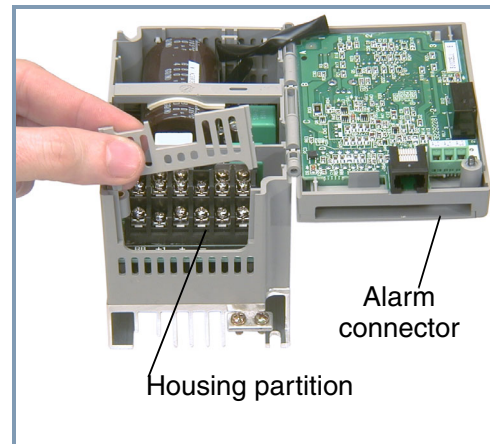

The following sections will describe the system design and guide you through a step-by-step installation process. After the section on wiring, this chapter will show how to use the front panel keys to access functions and edit parameters.

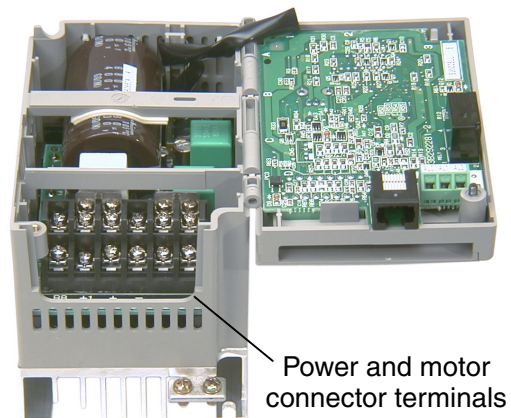

# Basic System Description

A motor control system will obviously include a motor and inverter, as well as a breaker or fuses for safety. If you are connecting a motor to the inverter on a test bench just to get started, that's all you may need for now. But a system can also have a variety of additional components. Some can be for noise suppression, while others may enhance the inverter's braking performance. The figure and table below show a system with all the optional components you may need in your finished application.

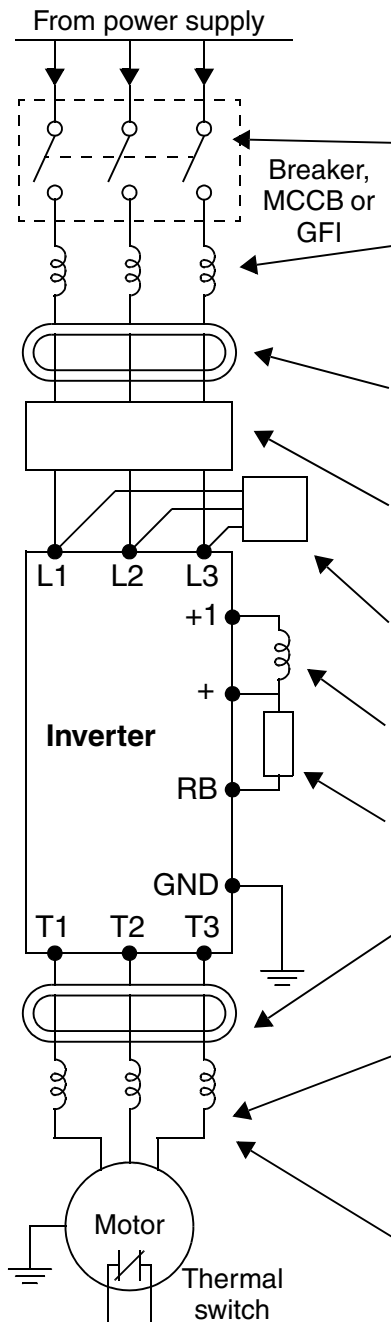

Name	Function
Breaker / disconnect	A molded-case circuit breaker (MCCB), ground fault interrupter (GFI), or a fused disconnect device. NOTE: The installer must refer to the NEC and local codes to ensure safety and compliance.
Input-side AC Reactor	This is useful in suppressing harmonics induced on the power supply lines and for improving the power factor. <b>WARNING:</b> Some applications <i>must</i> use an input-side AC reactor to prevent inverter damage. See Warning on next page.
Radio noise filter	Electrical noise interference may occur on nearby equipment such as a radio receiver. This magnetic choke filter helps reduce radiated noise (can also be used on output).
EMI filter (for CE applications, see Appendix D)	Reduces the conducted noise on the power supply wiring between the inverter and the power distribution system. Connect to the inverter primary (input side).
Radio noise filter (use in non-CE applications)	This capacitive filter reduces radiated noise from the main power wires in the inverter input side.
DC link choke	Suppresses harmonics generated by the inverter. However, it will not protect the input diode bridge rectifier.
Braking resistor	This is useful for increasing the inverter's control torque for high duty-cycle (ON-OFF) applications, and improving the decelerating capability.
Radio noise filter	Electrical noise interference may occur on nearby equipment such as a radio receiver. This magnetic choke filter helps reduce radiated noise (can also be used on input).
Output-side AC reactor	This reactor reduces the vibrations in the motor caused by the inverter's switching waveforms, by smoothing the waveform to approximate commercial power quality. It is also useful to reduce harmonics when wiring from the inverter to the motor is more than 10m in length.
LCR filter	Sine wave shaping filter for output side.

Inverter Mounting and Installation



**NOTE:** Note that some components are required for regulatory agency compliance (see Chapter 5 and Appendix C).



---

**WARNING:** In the cases below involving a general-purpose inverter, a large peak current can flow on the power supply side, sometimes destroying the converter module:

1. The unbalance factor of the power supply is 3% or higher.
2. The power supply capacity is at least 10 times greater than the inverter capacity (or the power supply capacity is 500 kVA or more).
3. Abrupt power supply changes are expected, due to conditions such as:
  - a. Several inverters are interconnected with a short bus.
  - b. A thyristor converter and an inverter are interconnected with a short bus.
  - c. An installed phase advance capacitor opens and closes.

Where these conditions exist or when the connected equipment must be highly reliable, you **MUST** install an input-side AC reactor of 3% (at a voltage drop at rated current) with respect to the supply voltage on the power supply side. Also, where the effects of an indirect lightning strike are possible, install a lightning conductor.

---

## Step-by-Step Basic Installation

This section will guide you through the following basic steps of installation:

1. Study the warnings and instructions associated with mounting the inverter.
2. Select a suitable mounting location.



---

**NOTE:** If the installation is in an EU country, study the EMC installation guidelines in Appendix C.

---

3. Place covers over the inverter's ventilation openings to prevent debris from entering.
4. Check the inverter mounting dimensions for footprint and mounting hole locations.
5. Study the caution and warning messages associated with wiring the inverter.
6. Connect wiring for the inverter power input.
7. Connect wiring to the motor.
8. Remove any covers applied in Step 3 from the inverter's ventilation openings.



---

**CAUTION:** The inverter is shipped with a plastic cover over the top vent grill. **REMOVE** this cover after the installation is complete. Operation with this cover in place will not allow proper cooling, and damage to the inverter may result.

---

9. Perform a powerup test.
  10. Make observations and check your installation.
-

## Choosing a Mounting Location



**Step 1:** Study the following caution messages associated with mounting the inverter. This is the time when mistakes are most likely to occur that will result in expensive rework, equipment damage, or personal injury.



**CAUTION:** Be sure to install the unit on flame-resistant material such as a steel plate. Otherwise, there is the danger of fire.



**CAUTION:** Be sure not to place any flammable materials near the inverter. Otherwise, there is the danger of fire.



**CAUTION:** Be sure not to let the foreign matter enter vent openings in the inverter housing, such as wire clippings, spatter from welding, metal shavings, dust, etc. Otherwise, there is the danger of fire.



**CAUTION:** Be sure to install the inverter in a place that can bear the weight according to the specifications in the text (Chapter 1, Specifications Tables). Otherwise, it may fall and cause injury to personnel.



**CAUTION:** Be sure to install the unit on a perpendicular wall that is not subject to vibration. Otherwise, it may fall and cause injury to personnel.



**CAUTION:** Be sure not to install or operate an inverter that is damaged or has missing parts. Otherwise, it may cause injury to personnel.



**CAUTION:** Be sure to install the inverter in a well-ventilated room that does not have direct exposure to sunlight, a tendency for high temperature, high humidity or dew condensation, high levels of dust, corrosive gas, explosive gas, inflammable gas, grinding-fluid mist, salt damage, etc. Otherwise, there is the danger of fire.

## Ensure Adequate Ventilation

2

**Step 2:** To summarize the caution messages—you will need to find a solid, non-flammable, vertical surface that is in a relatively clean and dry environment. In order to ensure enough room for air circulation around the inverter to aid in cooling, maintain the specified clearance around the inverter specified in the diagram.

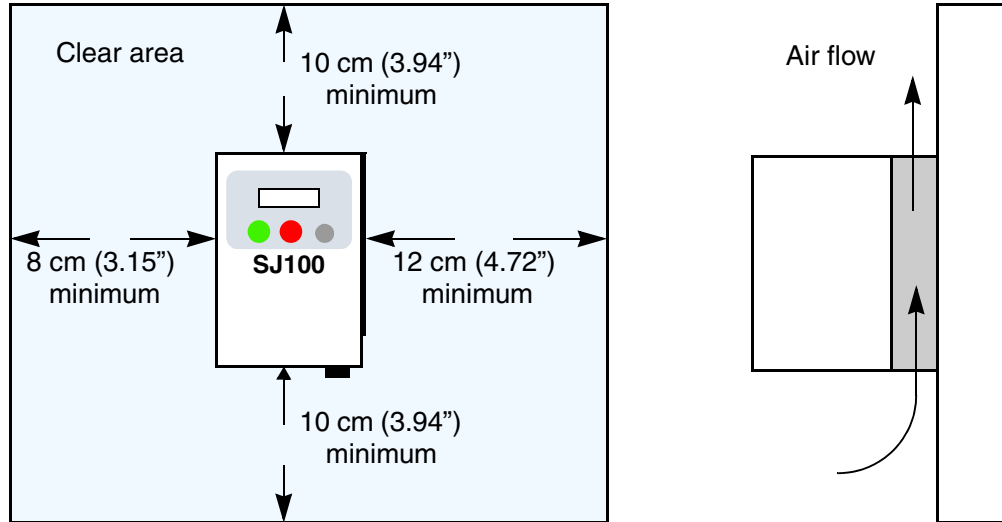

**CAUTION:** Be sure to maintain the specified clearance area around the inverter and to provide adequate ventilation. Otherwise, the inverter may overheat and cause equipment damage or fire.

## Keep Debris Out of Inverter Vents

3

**Step 3:** Before proceeding to the wiring section, it's a good time to *temporarily* cover the inverter's ventilation openings. Paper and masking tape are all that is needed. This will prevent harmful debris such as wire clippings and metal shavings from entering the inverter during installation. The inverter housing comes from the factory with a snap-in cover on the top of its housing. Ensure it is in place at this time (also to be removed later, unless the installation must have a NEMA rating).

Please observe this checklist while mounting the inverter:

1. The ambient temperature must be in the range of -10 to 40°C. If the range will be up to 50°C, you will need to set the carrier frequency to 2.1 kHz or less and derate the output current to 80% or less. Chapter 3 covers how to change parameters such as the carrier frequency. Remember to remove the top cover (unless the installation is to have a NEMA rating)!
2. Keep any other heat-producing equipment as far away from the inverter as possible.

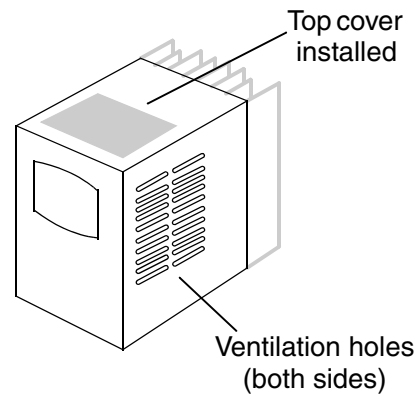



3. When installing the inverter in an enclosure, maintain the clearance around the inverter and verify that its ambient temperature is within specification when the enclosure door is closed.
4. Do not open the main front panel door at any time during operation.

### Check Inverter Dimensions

**Step 4:** Locate the applicable drawing on the following pages for your inverter.  
 4 Dimensions are given in millimeters (inches) format.

External Dimensions

	MODEL	H mm (in.)
SJ100	-002NFE	93 (3.66)
	-002NFU	93 (3.66)
	-004NFE	107 (4.21)
	-004NFU	107 (4.21)
	-005NFE	107 (4.21)

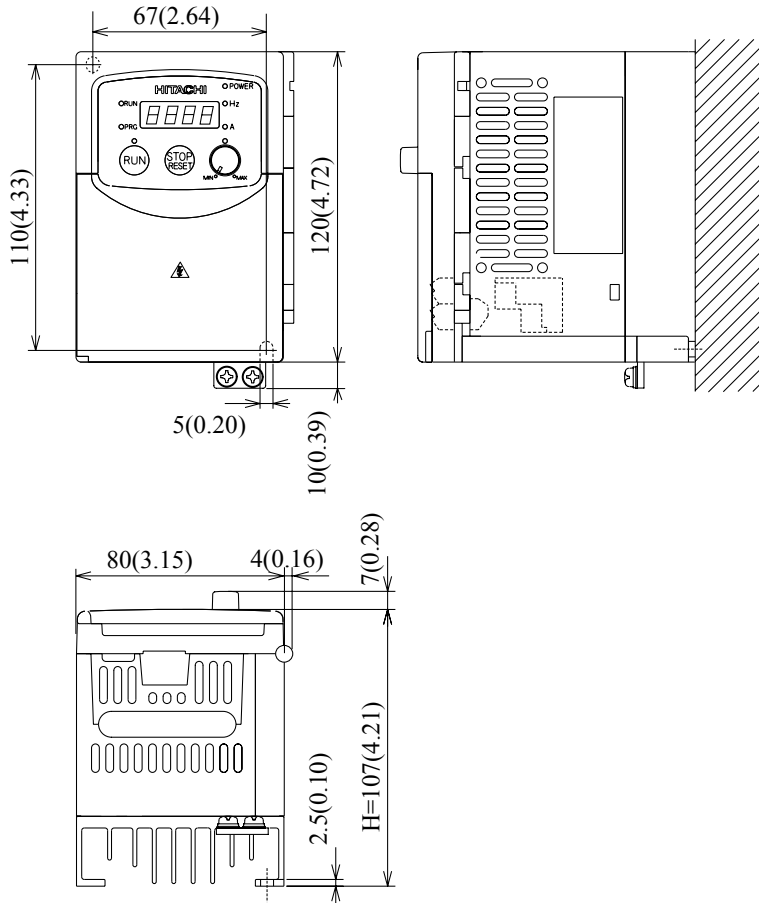

Inverter Mounting and Installation



**NOTE:** Some inverter housings require two mounting screws, while others require four. Be sure to use lock washers or other means to ensure screws do not loosen due to vibration.

Dimensional drawings, continued...

### External Dimensions

MODEL

- SJ 100 -004HFE
- 004HFU
- 007NFE
- 007NFU
- 011NFE

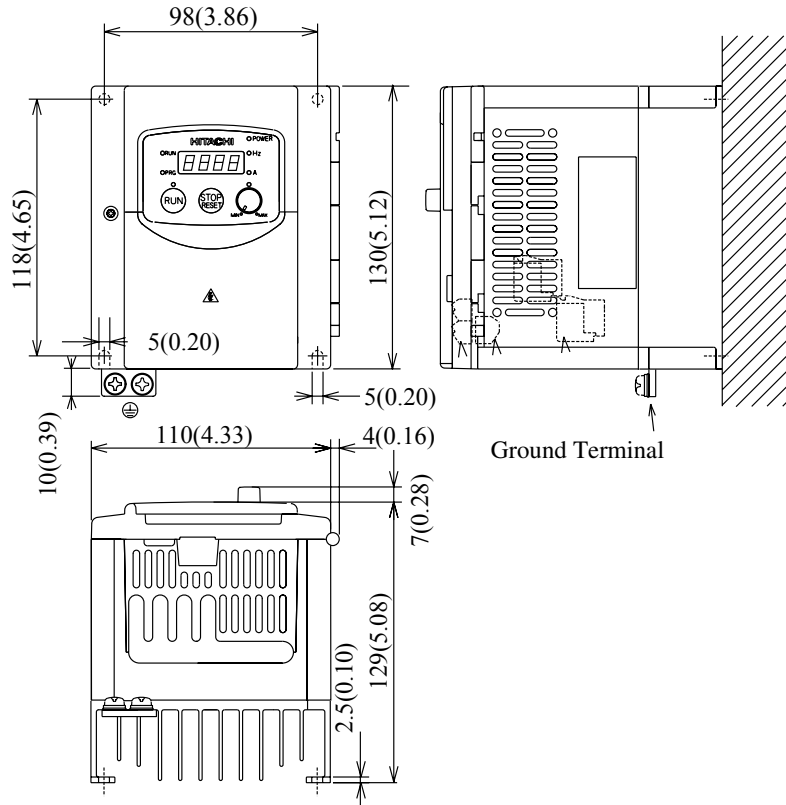

Inverter Mounting and Installation

MODEL

- SJ 100 -007HFE(No fan)
- 007HFU(No fan)
- 015HFE
- 015HFU
- 022HFE
- 022HFU

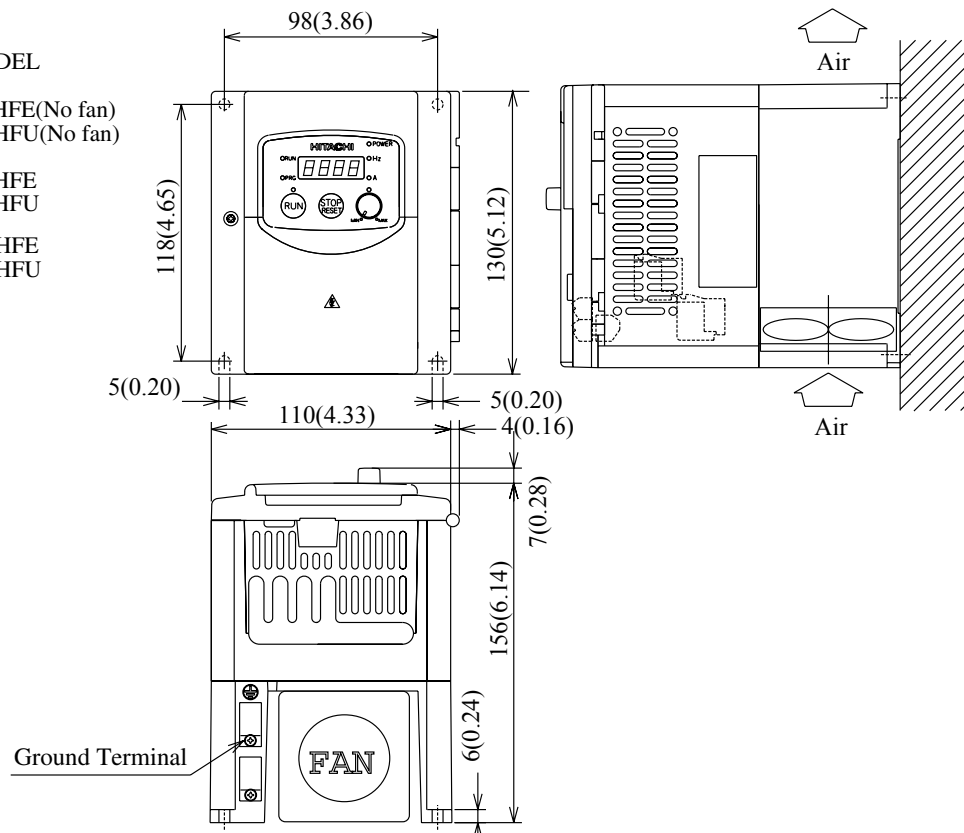

Dimensional drawings, continued...

SJ100 -015NFE  
-015NFU

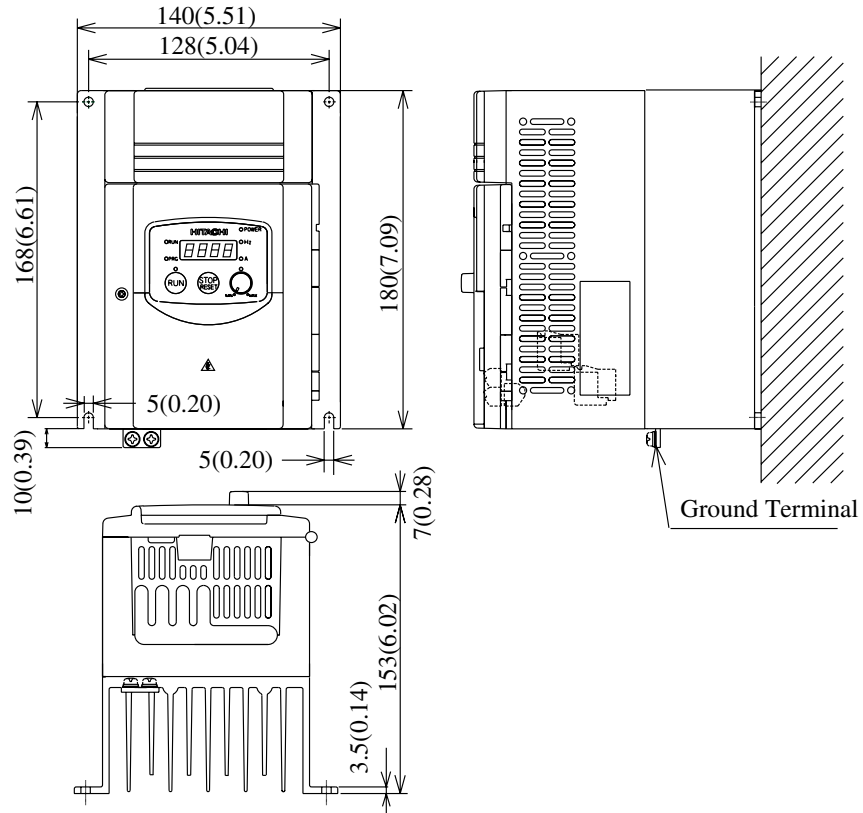

SJ100 -022NFE  
-022NFU  
-030HFE  
-037LFU  
-040HFE  
-040HFU

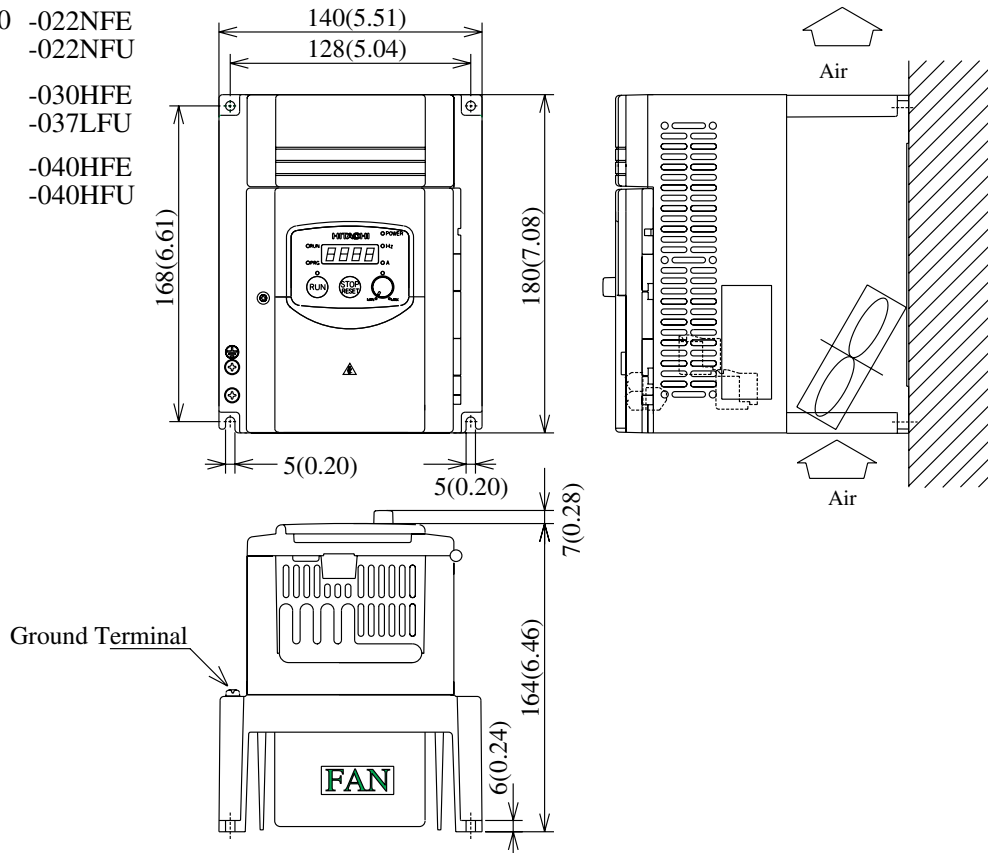

Inverter Mounting  
and Installation

Dimensional drawings, continued...

- SJ100 -055LFU
- 055HFE
- 055HFU
- 075LFU
- 075HFE
- 075HFU

Inverter Mounting and Installation

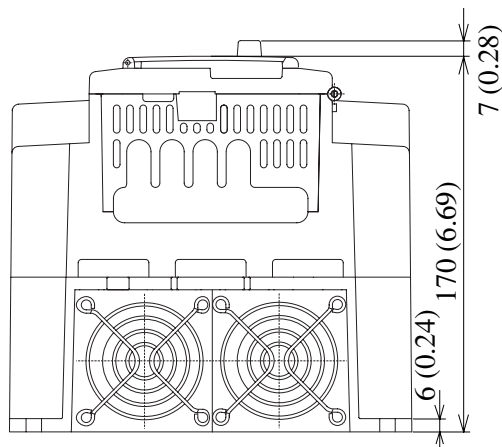
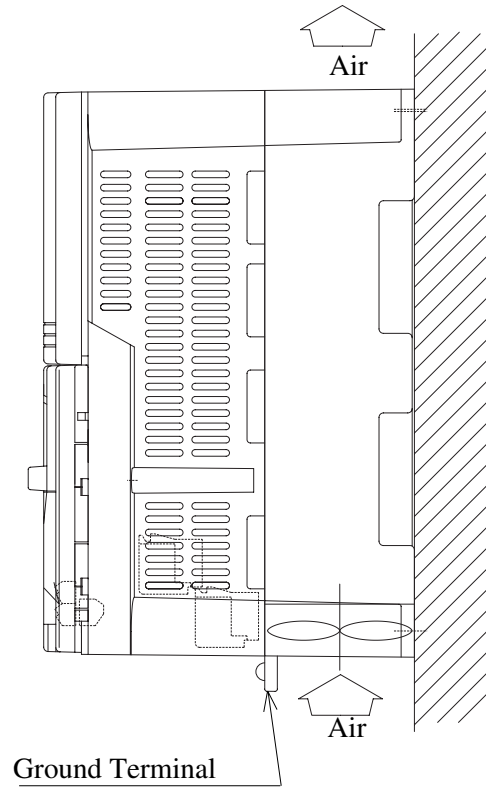
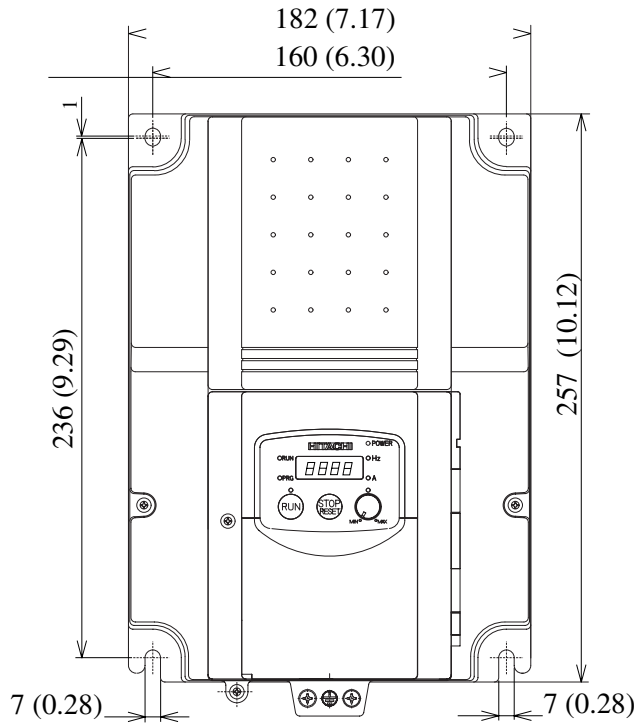

**NOTE:** Model SJ100-075LFU has (2) fans. All other models in this housing have (1) fan.

## Prepare for Wiring

5

**Step 5:** It is very important to perform the wiring steps carefully and correctly. Before proceeding, please study the caution and warning messages below.



**WARNING:** “Use 60/75°C Cu wire only” or equivalent.



**WARNING:** “Open Type Equipment.”



**WARNING:** “Suitable for use on a circuit capable of delivering not more than 5,000 rms symmetrical amperes, 240 V maximum.” For models with suffix N or L.



**WARNING:** “Suitable for use on a circuit capable of delivering not more than 5,000 rms symmetrical amperes, 480 V maximum.” For models with suffix H.



**HIGH VOLTAGE:** Be sure to ground the unit. Otherwise, there is a danger of electric shock and/or fire.



**HIGH VOLTAGE:** Wiring work shall be carried out only by qualified personnel. Otherwise, there is a danger of electric shock and/or fire.



**HIGH VOLTAGE:** Implement wiring after checking that the power supply is OFF. Otherwise, you may incur electric shock and/or fire.



**HIGH VOLTAGE:** Do not connect wiring to an inverter or operate an inverter that is not mounted according the instructions given in this manual. Otherwise, there is a danger of electric shock and/or injury to personnel.

### Determining Wire and Fuse Sizes

The maximum motor currents in your application determines the recommended wire size. The following table gives the wire size in AWG. The “Power Lines” column applies to the inverter input power, output wires to the motor, the earth ground connection, and any other component shown in the “Basic System Description” on page 2–5. The “Signal Lines” column applies to any wire connecting to the two green 8-position connectors just inside the front panel half-door.

Motor Output (kW/HP)		Inverter Model	Wiring		Applicable equipment
kW	HP		Power Lines	Signal Lines	Fuse (UL-rated, class J, 600V)
0.2	1/4	SJ100-002NFE/NFU	AWG16 / 1.3 mm <sup>2</sup>	18 to 28 AWG / 0.14 to 0.75 mm <sup>2</sup> shielded wire (see Note 4)	10A (single ph.) 7A (three ph.)
0.4	1/2	SJ100-004NFE/NFU			
0.55	3/4	SJ100-005NFE			
0.75	1	SJ100-007NFE/NFU	AWG14 / 2.1 mm <sup>2</sup>		15A (single ph.) 10A (three ph.)
1.1	1 1/2	SJ100-011NFE			
1.5	2	SJ100-015NFE/NFU	AWG12 / 3.3 mm <sup>2</sup>		20A (single ph.) 15A (three ph.)
2.2	3	SJ100-022NFE/NFU	AWG10 / 5.3 mm <sup>2</sup>		30A (single ph.) 20A (three ph.)
3.7	5	SJ100-037LFU	AWG12 / 3.3 mm <sup>2</sup>		30A
5.5	7 1/2	SJ100-055LFU	AWG10 / 5.3 mm <sup>2</sup>		40A
7.5	10	SJ100-075LFU	AWG8 / 8.4 mm <sup>2</sup>		50A
0.4	1/2	SJ100-004HFE/HFU	AWG16 / 1.3 mm <sup>2</sup>		3A
0.75	1	SJ100-007HFE/HFU			6A
1.5	2	SJ100-015HFE/HFU			10A
2.2	3	SJ100-022HFE/HFU			
3.0	4	SJ100-030HFE	AWG14 / 2.1 mm <sup>2</sup>		15A
4.0	5	SJ100-040HFE/HFU			
5.5	7 1/2	SJ100-055HFE/HFU	AWG12 / 3.3 mm <sup>2</sup>	20A	
7.5	10	SJ100-075HFE/HFU		25A	

**Note 1:** Field wiring must be made by a UL-listed and CSA-certified closed-loop terminal connector sized for the wire gauge involved. Connector must be fixed by using the crimping tool specified by the connector manufacturer.

**Note 2:** Be sure to consider the capacity of the circuit breaker to be used.

**Note 3:** Be sure to use a larger wire gauge if power line length exceeds 66 ft (20m).

**Note 4:** Use 18 AWG / 0.75 mm<sup>2</sup> wire for the alarm signal wire ([AL0], [AL1], [AL2] terminals).

## Terminal Dimensions and Torque Specs

The terminal screw dimensions for all SJ100 inverters are listed in table below. This information is useful in sizing spade lug or ring lug connectors for wire terminations.



**CAUTION:** Fasten the screws with the specified fastening torque in the table below. Check for any loosening of screws. Otherwise, there is the danger of fire.

Connector	Number of Screw Terminals	Models 002NF, 004NF, 005NF		Models 007NF-022NF, 037LF, 004HF - 040HF		Models 055LF, 075LF, 055HF, 075HF	
		Screw Diameter	Width (mm)	Screw Diameter	Width (mm)	Screw Diameter	Width (mm)
Power Terminals	12	M3.5	7.1	M4	9	M5	13
Control Signal	16	M2	—	M2	—	M2	—
Alarm Signal	3	M3	—	M3	—	M3	—
Ground Terminals	2	M4	—	M4	—	M5	—

Inverter Mounting and Installation

When connecting wiring, use the tightening torque listed in the following table to safely attach wiring to the connectors.

Screw	Tightening Torque	Screw	Tightening Torque	Screw	Tightening Torque
M2	0.2 N•m (max. 0.25 N•m)	M3.5	0.8 N•m (max. 0.9 N•m)	M5	2.0 N•m (max. 2.2 N•m)
M3	0.5 N•m (max. 0.6 N•m)	M4	1.2 N•m (max. 1.3 N•m)	—	—

## Wire the Inverter Input to a Supply



**Step 6:** In this step, you will connect wiring to the input of the inverter. First, you must determine whether the inverter model you have requires three-phase power only, or if it can accept either single-phase or three-phase power. All models have the same power connector terminals [L1], [L2], and [N/L3]. So, you must refer to the specifications label (on the side of the inverter) for the acceptable power source types! For inverters that can accept single-phase power and are connected that way, terminal [L2] will remain unconnected. The wiring example to the right shows an SJ100 inverter wired for 3-phase input. Note the use of ring lug connectors for a secure connection.

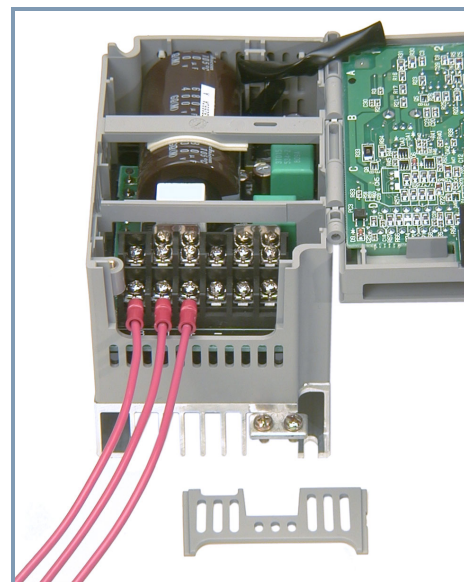

Please use the terminal arrangement below corresponding to your inverter model.

Inverter Mounting and Installation

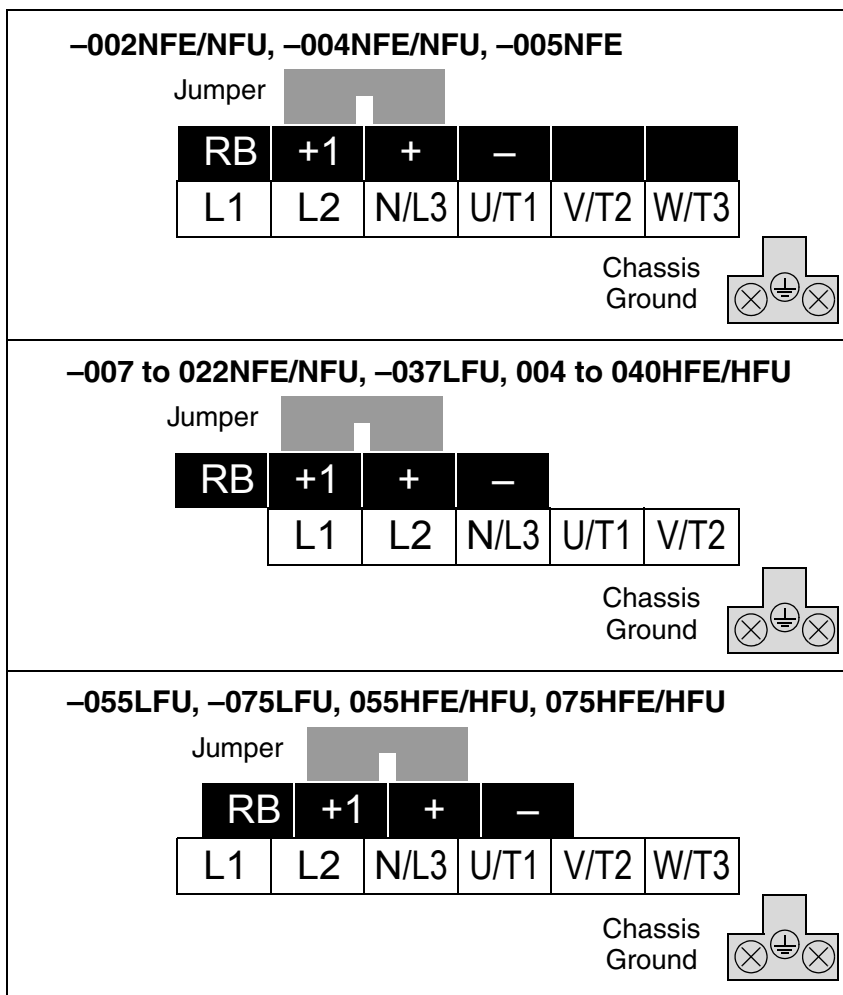

**NOTE:** An inverter powered by a portable power generator may receive a distorted power waveform, overheating the generator. In general, the generator capacity should be five times that of the inverter (kVA).



**CAUTION:** Be sure that the input voltage matches the inverter specifications:

- Single/Three phase 200 to 240 V 50/60 Hz (up to 2.2kW)
- Three phase 200 to 230V 50/60Hz (above 2.2kW)
- Three phase 380 to 460 V 50/60Hz



**CAUTION:** Be sure not to power a three-phase-only inverter with single phase power. Otherwise, there is the possibility of damage to the inverter and the danger of fire.





**CAUTION:** Be sure not to connect an AC power supply to the output terminals. Otherwise, there is the possibility of damage to the inverter and the danger of injury and/or fire.

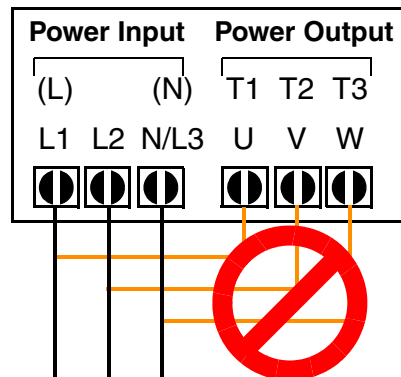

NOTE:

L, N: Single-phase 200 to 240V 50/60 Hz  
 L1, L2, L3: Three-phase 200 to 230V 50/60 Hz  
 Three-phase 380 to 460V 50/60 Hz



**CAUTION:** Remarks for using ground fault interrupter breakers in the main power supply:

Adjustable frequency inverters with CE-filters (RFI-filter) and shielded (screened) motor cables have a higher leakage current toward Earth GND. Especially at the moment of switching ON this can cause an inadvertent trip of ground fault interrupters. Because of the rectifier on the input side of the inverter there is the possibility to stall the switch-off function through small amounts of DC current. Please observe the following:

- Use only short time-invariant and pulse current-sensitive ground fault interrupters with higher trigger current.
- Other components should be secured with separate ground fault interrupters.
- Ground fault interrupters in the power input wiring of an inverter are not an absolute protection against electric shock.



**CAUTION:** Be sure to install a fuse in each phase of the main power supply to the inverter. Otherwise, there is the danger of fire.



**CAUTION:** For motor leads, ground fault interrupter breakers and electromagnetic contactors, be sure to size these components properly (each must have the capacity for rated current and voltage). Otherwise, there is the danger of fire.

## Wire the Inverter Output to Motor

7

**Step 7:** The process of motor selection is beyond the scope of this manual. However, it must be an AC induction motor with three phases. It should also come with a chassis ground lug. If the motor does not have three power input leads, stop the installation and verify the motor type. Other guidelines for wiring the motor include:

- Use an inverter-grade motor for maximum motor life (1600V insulation).
- For standard motors, use the AC reactor accessory if the wiring between the inverter and motor exceeds 10 meters in length.

Simply connect the motor to the terminals [U/T1], [V/T2], and [W/T3] as shown to the right. This is a good time to connect the chassis ground lug on the drive as well. The motor chassis ground must also connect to the same point. Use a star ground (single-point) arrangement, and never daisy-chain the grounds (point-to-point).

Use the same wire gauge on the motor and chassis ground wiring as you used on the power input wiring in the previous step. After completing the wiring:

- Check the mechanical integrity of each wire crimp and terminal connection.
- Replace the housing partition that covers access to the power connections.
- Close the main door and secure the retention screw firmly.

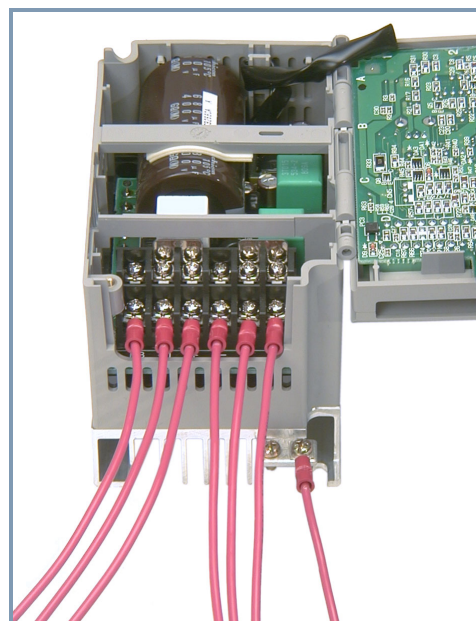

To Power Supply      To Motor      To Chassis Ground

## Logic Control Wiring

After completing the initial installation and powerup test in this chapter, you may need to wire the logic signal connector for your application. For new inverter users/applications, we highly recommend that you first complete the powerup test in this chapter without adding any logic control wiring. Then you will be ready to set the required parameters for logic control as covered in Chapter 4, Operations and Monitoring.

## Uncover the Inverter Vents

8

**Step 8:** After mounting and wiring the inverter, remove any covers from the inverter housing. This includes material over the side ventilation ports. Remove the square cover panel at the top of the housing.



**WARNING:** Make sure the input power to the inverter is OFF. If the drive has been powered, leave it OFF for five minutes before continuing.



The top housing cover is held in place by four locking tabs. To remove the cover, squeeze two corners together and push a small screwdriver under one side as shown, while pulling upward. Hold the screwdriver at the angle shown, and **DO NOT** push the screwdriver or any object through ventilation openings and into the inverter.

## Powerup Test

9

**Step 9:** After wiring the inverter and motor, you're ready to do a powerup test. The procedure that follows is designed for the first-time use of the drive. Please verify the following conditions before conducting the powerup test:

- You have followed all the steps in this chapter up to this step.
- The inverter is new, and is securely mounted to a non-flammable vertical surface
- The inverter is connected to a power source and motor.
- No additional wiring of inverter connectors or terminals has been done.
- The power supply is reliable, and the motor is a known working unit, and the motor nameplate ratings match the inverter ratings.
- The motor is securely mounted, and is not connected to any load.

### Goals for the Powerup Test

If there are any exceptions to the above conditions at this step, please take a moment to take any measures necessary to reach this basic starting point. The specific goals of this powerup test are:

1. Verify that the wiring to the power supply and motor is correct.
2. Demonstrate that the inverter and motor are generally compatible.
3. Give a brief introduction to the use of the built-in operator keypad.

The powerup test gives you an important starting point to ensure a safe and successful application of the Hitachi inverter. We highly recommend performing this test before proceeding to the other chapters in this manual.

## Pre-test and Operational Precautions

The following instructions apply to the powerup test, or to any time the inverter is powered and operating. Please study the following instructions and messages before proceeding with the powerup test.

1. The power supply must have fusing suitable for the load. Check the fuse size chart presented in Step 5, if necessary.
2. Be sure you have access to a disconnect switch for the drive input power if necessary. However, do not turn OFF power during inverter operation unless it is an emergency.
3. Turn the front panel potentiometer to the *MIN* position (fully counter-clockwise).



**CAUTION:** The heat sink fins will have a high temperature. Be careful not to touch them. Otherwise, there is the danger of getting burned.



**CAUTION:** The operation of the inverter can be easily changed from low speed to high speed. Be sure to check the capability and limitations of the motor and machine before operating the inverter. Otherwise, there is the danger of injury.



**CAUTION:** If you operate a motor at a frequency higher than the inverter standard default setting (50Hz/60Hz), be sure to check the motor and machine specifications with the respective manufacturer. Only operate the motor at elevated frequencies after getting their approval. Otherwise, there is the danger of equipment damage and/or injury.



**CAUTION:** Check the following before and during the powerup test. Otherwise, there is the danger of equipment damage.

- Is the shorting bar between the [+1] and [+] terminals installed? DO NOT power or operate the inverter if the jumper is removed.
- Is the direction of the motor rotation correct?
- Did the inverter trip during acceleration or deceleration?
- Were the rpm and frequency meter readings as expected?
- Were there any abnormal motor vibrations or noise?

## Powering the Inverter

If you have followed all the steps, cautions and warnings up to this point, you're ready to apply power. After doing so, the following events should occur:

- The *POWER* LED will illuminate.
- The numeric (7-segment) LEDs will display a test pattern, then stop at *0.0*.
- The *Hz* LED will be ON.

If the motor starts running unexpectedly or any other problem occurs, press the *STOP* key. Only if necessary should you remove power to the inverter as a remedy.



**NOTE:** If the inverter has been previously powered and programmed, the LEDs (other than the *POWER* LED) may illuminate differently than as indicated above. If necessary, you can initialize all parameters to the factory default settings. See “Restoring Factory Default Settings” on page 6–8.

## Using the Front Panel Keypad

### Front Panel Introduction

Please take a moment to familiarize yourself with the keypad layout shown in the figure below. These are the visible controls and indicators when the front panel door is closed.

The display is used in programming the inverter's parameters, as well as monitoring specific parameter values during operation. Many functions are applicable only during the initial installation, while others are more useful for maintenance or monitoring.

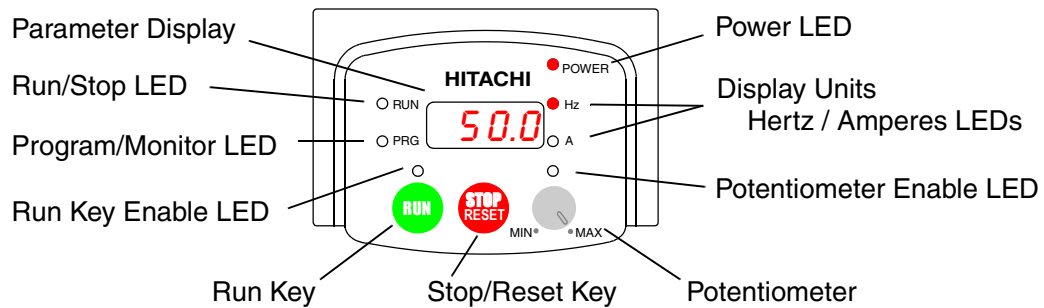

### Parameter Editing Controls

Now, open the front panel (half-door) for second-level access to reveal additional operator keys for parameter editing as shown to the right. In normal operation after installation, parameter editing is unnecessary, so these controls are hidden from view. The front panel controls and indicators are described as follows:

- **Run/Stop LED** - ON when the inverter output is ON and the motor is developing torque (Run Mode), and OFF when the inverter output is OFF (Stop Mode).
- **Program/Monitor LED** - This LED is ON when the inverter is ready for parameter editing (Program Mode). It is OFF when the parameter display is monitoring data (Monitor Mode).
- **Run Key Enable LED** - is ON when the inverter is ready to respond to the Run key, OFF when the Run key is disabled.
- **Run Key** - Press this key to run the motor (the Run Enable LED must be ON first). Parameter F\_04, Keypad Run Key Routing, determines whether the Run key generates a Run FWD or Run REV command.
- **Stop/Reset Key** - Press this key to stop the motor when it is running (uses the programmed deceleration rate). This key will also reset an alarm that has tripped.
- **Potentiometer** - Allows an operator to directly set the motor speed when the potentiometer is enabled for output frequency control.
- **Potentiometer Enable LED** - ON when the potentiometer is enabled for value entry.

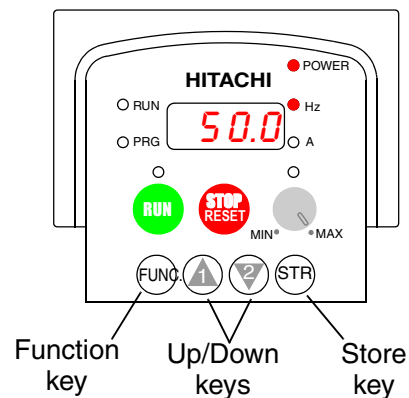

- **Parameter Display** - A 4-digit, 7-segment display for parameters and function codes.
- **Display Units, Hertz/Amperes** - One of these LEDs will be ON to indicate the units associated with the parameter display.
- **Power LED** - This LED is ON when the power input to the inverter is ON.
- **Function Key** - This key is used to navigate through the lists of parameters and functions for setting and monitoring parameter values.
- **Up/Down (  $\triangle$ ,  $\nabla$  ) Keys** - Use these keys alternately to move up or down the lists of parameter and functions shown in the display, and increment/decrement values.
- **Store (  $\text{STR}$  ) Key** - When the unit is in Program Mode and you have edited a parameter value, press the Store key to write the new value to the EEPROM.

### Keys, Modes, and Parameters

Purpose of the keypad is to provide a way to change modes and parameters. The term *function* applies to both monitoring modes and parameters. These are all accessible through *function codes* that are primarily 3-character codes. The various functions are separated into related groups identifiable by the left-most character, as the table shows.

Function Group	Type (Category) of Function	Mode to Access	PGM LED Indicator
“D”	Monitoring functions	Monitor	○
“F”	Main profile parameters	Program	●
“A”	Standard functions	Program	●
“B”	Fine tuning functions	Program	●
“C”	Intelligent terminal functions	Program	●
“H”	Motor constant functions	Program	●
“E”	Error codes	—	—

For example, function “A\_04” is the *base frequency setting* for the motor, typically 50 Hz or 60 Hz. To edit the parameter, the inverter must be in Program Mode (PGM LED will be ON). You use the front panel keys to first select the function code “A\_04.” After displaying the value for “A\_04,” use the Up/Down (  $\triangle$  or  $\nabla$  ) keys to edit it.



**NOTE:** The inverter 7-segment display shows lower case “b” and “d,” meaning the same as the upper case letters “B” and “D” used in this manual (for uniformity “A to F”).

The inverter automatically switches into Monitor Mode when you access “D” Group functions. It switches into Program Mode when you access any other group, because they all have editable parameters. Error codes use the “E” Group, and appear automatically when a fault event occurs. Refer to “Monitoring Trip Events, History, & Conditions” on page 6-5 for error code details.

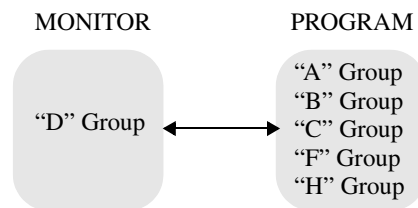

## Keypad Navigational Map

The SJ100 Series inverter drives have many programmable functions and parameters. Chapter 3 will cover these in detail, but you need to access just a few items to perform the powerup test. The menu structure makes use of function codes and parameter codes to allow programming and monitoring with only a 4-digit display and a few keys and LEDs. So, it is important to become familiar with the basic navigational map of parameters and functions in the diagram below. You may later use this map as a reference.

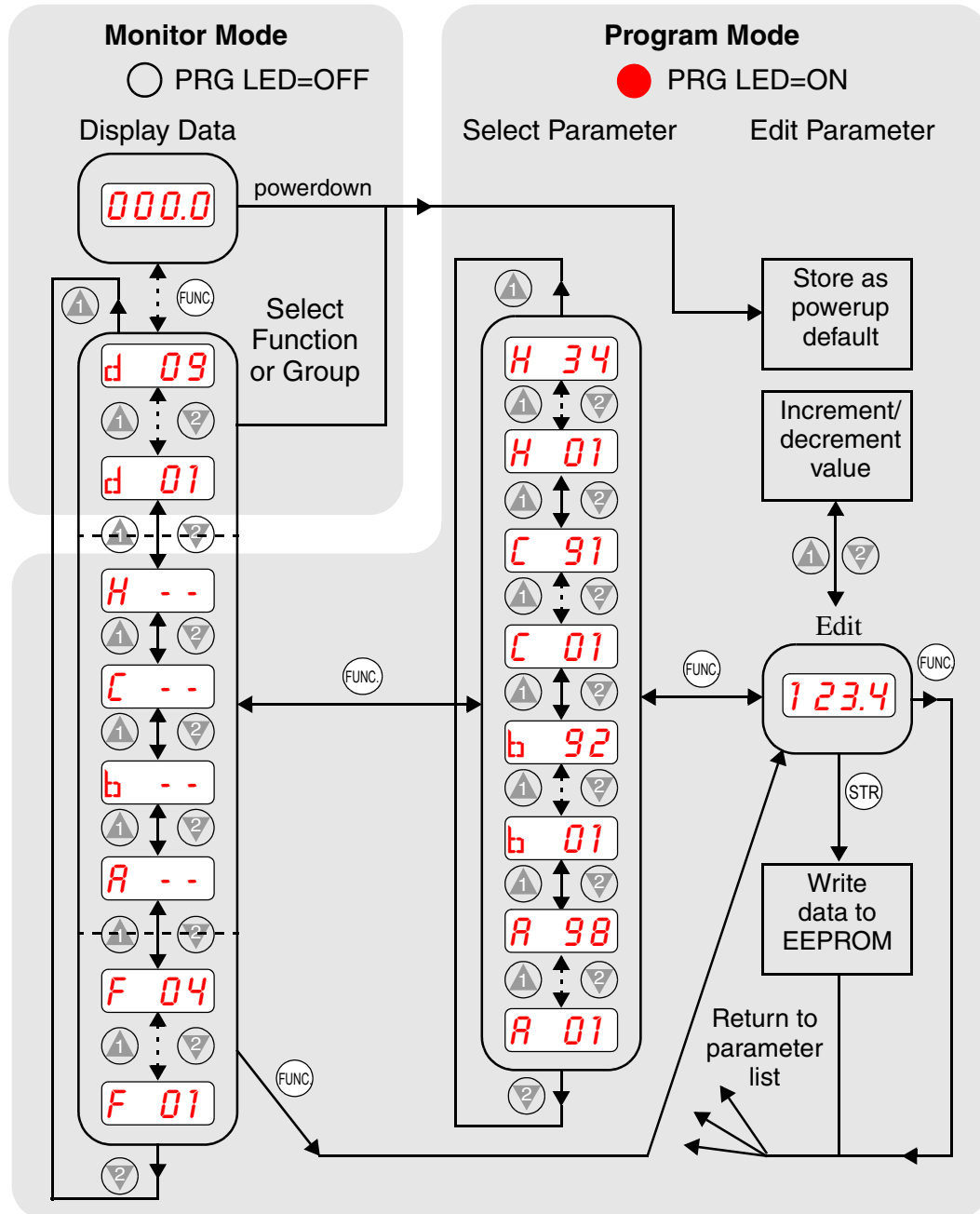

Inverter Mounting and Installation

The navigational map shows the relationship of all resources of the inverter in one view. In general, use the **FUNC.** key to move left and right, and the **▲ ▼** (arrow) keys to move up and down.

### Selecting Functions and Editing Parameters

In order to run the motor for the powerup test, this section will show how to:

- select the inverter’s maximum output frequency to the motor
- select the keypad potentiometer as the source of motor speed command
- select the keypad as the source of the RUN command
- set the number of poles for the motor
- enable the RUN command

The following series of programming tables are designed for successive use. Each table uses the previous table’s final state as the starting point. Therefore, start with the first and continue programming until the last one. If you get lost or concerned that some of the other parameters settings may be incorrect, refer to “Restoring Factory Default Settings” on page 6–8.



**CAUTION:** If you operate a motor at a frequency higher than the inverter standard default setting (50Hz/60Hz), be sure to check the motor and machine specifications with the respective manufacturer. Only operate the motor at elevated frequencies after getting their approval. Otherwise, there is the danger of equipment damage.

**Setting the Motor Base Frequency** -The motor is designed to operate at a specific AC frequency. Most commercial motors are designed for 50/60 Hz operation. First, check the motor specifications. Then follow the steps in the table below to verify the setting or correct for your motor. **DO NOT** set it for greater than 50/60 Hz unless the motor manufacturer specifically approves operation at the higher frequency.

Action	Display	Func./Parameter
Press the  key.		Monitor functions
Press the  or  keys until ->		“A” Group selected
Press the  key.		First “A” parameter
Press the  key twice.		Base frequency setting
Press the  key.	 or 	Default value for base frequency. US = 60 Hz, Europe = 50 Hz.
Press the  or  key as needed.		Set to your motor specs (your display may be different)
Press the  key.		Stores parameter, returns to “A” Group list











**TIP:** If you need to scroll through a function or parameter list, press and hold the or key to auto-increment through the list.



**Select the Potentiometer for Speed Command** - The motor speed may be controlled from the following sources:









- Potentiometer on front panel keypad
- Control terminals
- Remote panel

Then follow the steps in the table below to select the potentiometer for the speed command (the table resumes action from the end of the previous table).

Action	Display	Func./Parameter
Press the  key twice.		Speed command source setting
Press the  key.		0 = potentiometer 1 = control terminals (default) 2 = keypad
Press the  key.		0 = potentiometer (selected)
Press the  key.		Stores parameter, returns to “A” Group list

Inverter Mounting and Installation

**Select the Keypad for the RUN Command** - The RUN command causes the inverter to accelerate the motor to the selected speed. You can program the inverter to respond to either the control terminal signal or the keypad RUN key. Follow the steps in the table below to select the front panel RUN key as the source for the RUN Command (the table resumes action from the end of the previous table).













Action	Display	Func./Parameter
Press the  key.		Run command source
Press the  key.		1 = control terminals (default) 2 = keypad
Press the  key.		2 = keypad (selected)
Press the  key.		Stores parameter, returns to “A” Group list

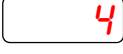

**NOTE:** When you press the STR key in the last step above (and the display = 02), the Run Enable LED above the RUN switch on the keypad will turn ON. This is normal, and does not mean the motor is trying to run. It means that the RUN key is now enabled. DO NOT press the RUN key at this time—finish out the programming exercise first.

**Configure the Inverter for the Number of Motor Poles-** The number of magnetic poles of a motor is determined by the motor's internal winding arrangement. The specifications label on the motor usually indicates its number of poles. For proper operation, verify the parameter setting matches the motor poles. Many industrial motors have four poles, corresponding to the default setting in the inverter.

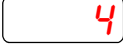
Follow the steps in the table below to verify the motor poles setting and change it if necessary (the table resumes action from the end of the previous table.)

Action	Display	Func./Parameter
Press the  key.		"A" Group selected
Press the  key three times.		"H" Group selected
Press the  key.		First "H" parameter
Press the  key three times.		Motor poles parameter
Press the  key.		2 = 2 poles 4 = 4 poles (default) 6 = 6 poles 8 = 8 poles
Press the  or  key as needed.		Set to match your motor (your display may be different)
Press the  key.		Stores parameter, returns to "H" Group list

This step concludes the parameter setups for the inverter. You are almost ready to run the motor for the first time!



**TIP:** If you became lost during any of these steps, first observe the state of the PRG LED. Then study the "Keypad Navigational Map" on page 2-23 to determine the current state of the keypad controls and display. As long as you do not press the STR key, no parameters will be changed by keypad entry errors. Note that power cycling the inverter will not cause it to reset to a particular programming state.

The next section will show you how to monitor a particular parameter from the display. Then you will be ready to run the motor.



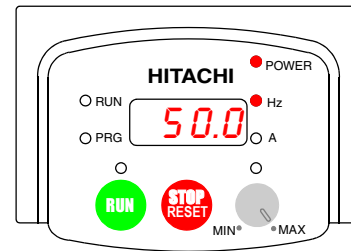

## Monitoring Parameters with the Display

After using the keypad for parameter editing, it's a good idea to switch the inverter from Program Mode to Monitor Mode and close the panel door (puts the keys for parameter editing out of sight). This will also turn out the PRG LED, and the Hertz or Ampere LED indicates the display units.

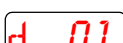

For the powerup test, monitor the motor speed indirectly by viewing the inverter's output frequency. The *output frequency* must not be confused with *base frequency* (50/60 Hz) of the motor, or the *carrier frequency* (switching frequency of the inverter, in the kHz range). The monitoring functions are in the "D" list, located near the top left of the "Keypad Navigational Map" on page 2-23.

**Output frequency (speed) monitor** - Resuming the keypad programming from the previous table, follow the steps in the table below.

Action	Display	Func./Parameter
Press the  key.		"H" Group selected
Press the  key.		Output frequency selected
Press the  key.		Output frequency displayed

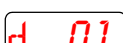
When the  function code appeared, the PRG LED went OFF. This confirms the inverter is no longer in programming mode, even while you are selecting the particular monitoring parameter. After pressing the Function key, the display shows the current speed (is zero at this point).

## Running the Motor

If you have programmed all the parameters up to this point, you're ready to run the motor! First, review this checklist:

1. Verify the Power LED is ON. If not, check the power connections.
2. Verify the Run Key Enable LED is ON. If not, review the programming steps to find the problem.
3. Verify the PRG LED is OFF. If it is ON, review the instructions above.
4. Make sure the motor is disconnected from any mechanical load.
5. Turn the potentiometer to the MIN position (completely counterclockwise).
6. Now, press the RUN key on the keypad. The RUN LED will turn ON.
7. Slowly increase the potentiometer setting in clockwise fashion. The motor should start turning when the indicator is in the 9:00 position and beyond.
8. Press the STOP key to stop the motor rotation.

## Powerup Test Observations and Summary

10

**Step 10:** Reading this section will help you make some useful observations when first running the motor.

**Error Codes** - If the inverter displays an error code (format is “*EXX*”), see “Monitoring Trip Events, History, & Conditions” on page 6-5 to interpret and clear the error.

**Acceleration and Deceleration** - The SJ100 inverter has programmable acceleration and deceleration values. The test procedure left these at the default value, 10 seconds. You can observe this by setting the potentiometer at about half speed before running the motor. Then press RUN, and the motor will take 5 seconds to reach a steady speed. Press the STOP key to see a 5 second deceleration to a stop.

**State of Inverter at Stop** - If you adjust the motor’s speed to zero, the motor will slow to a near stop, and the inverter turns the outputs OFF. The high-performance SJ100 can rotate at a very slow speed with high torque output, but not zero (must use servo systems with position feedback for that feature). This characteristic means you must use a mechanical brake for some applications.

**Interpreting the Display** - First, refer to the output frequency display readout. The maximum frequency setting (parameter A\_04) defaults to 50 Hz or 60 Hz (Europe and United States, respectively) for your application.

Example: Suppose a 4-pole motor is rated for 60 Hz operation, so the inverter is configured to output 60 Hz at full scale. Use the following formula to calculate the RPM.

$$\text{Speed in RPM} = \frac{\text{Frequency} \times 60}{\text{Pairs of poles}} = \frac{\text{Frequency} \times 120}{\# \text{ of poles}} = \frac{60 \times 120}{4} = 1800\text{RPM}$$

The theoretical speed for the motor is 1800 RPM (speed of torque vector rotation). However, the motor cannot generate torque unless its shaft turns at a slightly different speed. This difference is called *slip*. So it’s common to see a rated speed of approximately 1750 RPM on a 60 Hz, 4-pole motor. Using a tachometer to measure shaft speed, you can see the difference between the inverter output frequency and the actual motor speed. The slip increases slightly as the motor’s load increases. This is why the inverter output value is called “frequency,” since it is not exactly equal to motor speed. You can program the inverter to display output frequency in units more directly related to the load speed by entering a constant (discussed more in depth on page 3-30).

### Run/Stop Versus Monitor/Program Modes –

The Run LED on the inverter is ON in Run Mode, and OFF in Stop Mode. The Program LED is ON when the inverter is in Program Mode, and OFF for Monitor Mode. All four mode combinations are possible. The diagram to the right depicts the modes and the mode transitions via keypad.

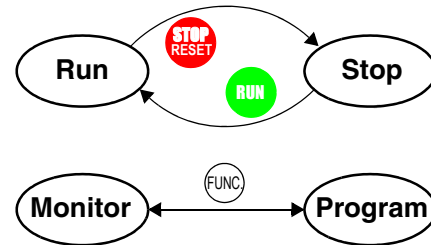

**NOTE:** Some factory automation devices such as PLCs have alternate Run/Program modes; the device is in either one mode or the other. In the Hitachi inverter, however, Run Mode alternates with Stop Mode, and Program Mode alternates with Monitor Mode. This arrangement lets you program some values while the inverter is operating—providing flexibility for maintenance personnel.