

Safety Messages

For the best results with the SJ100 Series inverter, carefully read this manual and all of the warning labels attached to the inverter before installing and operating it, and follow the instructions exactly. Keep this manual handy for quick reference.

Definitions and Symbols

A safety instruction (message) includes a “Safety Alert Symbol” and a signal word or phrase such as **WARNING** or **CAUTION**. Each signal word has the following meaning:



HIGH VOLTAGE: This symbol indicates high voltage. It calls your attention to items or operations that could be dangerous to you and other persons operation this equipment. Read the message and follow the instructions carefully.



WARNING: Indicates a potentially hazardous situation that, if not avoided, can result in serious injury or death.



CAUTION: Indicates a potentially hazardous situation that, if not avoided, can result in minor to moderate injury, or serious damage to the product. The situation described in the **CAUTION** may, if not avoided, lead to serious results. Important safety measures are described in **CAUTION** (as well as **WARNING**), so be sure to observe them.



Step 1: Indicates a step in a series of action steps required to accomplish a goal. The number of the step will be contained in the step symbol.



NOTE: Notes indicate an area or subject of special merit, emphasizing either the product’s capabilities or common errors in operation or maintenance.



TIP: Tips give a special instruction that can save time or provide other benefits while installing or using the product. The tip calls attention to an idea that may not be obvious to first-time users of the product.

Hazardous High Voltage



HIGH VOLTAGE: Motor control equipment and electronic controllers are connected to hazardous line voltages. When servicing drives and electronic controllers, there may be exposed components with housings or protrusions at or above line potential. Extreme care should be taken to protect against shock.

Stand on an insulating pad and make it a habit to use only one hand when checking components. Always work with another person in case an emergency occurs. Disconnect power before checking controllers or performing maintenance. Be sure equipment is properly grounded. Wear safety glasses whenever working on electronic controllers or rotating machinery.

General Precautions - Read These First!



WARNING: This equipment should be installed, adjusted, and serviced by qualified electrical maintenance personnel familiar with the construction and operation of the equipment and the hazards involved. Failure to observe this precaution could result in bodily injury.



WARNING: The user is responsible for ensuring that all driven machinery, drive train mechanism not supplied by Hitachi Industrial Equipment Systems Co., Ltd., and process line material are capable of safe operation at an applied frequency of 150% of the maximum selected frequency range to the AC motor. Failure to do so can result in destruction of equipment and injury to personnel should a single-point failure occur.



WARNING: For equipment protection, install a ground leakage type breaker with a fast response circuit capable of handling large currents. The ground fault protection circuit is not designed to protect against personal injury.



WARNING: HAZARD OF ELECTRICAL SHOCK. DISCONNECT INCOMING POWER BEFORE WORKING ON THIS CONTROL.



WARNING: Wait at least five (5) minutes after turning OFF the input power supply before performing maintenance or an inspection. Otherwise, there is the danger of electric shock.



CAUTION: These instructions should be read and clearly understood before working on SJ100 series equipment.



CAUTION: Proper grounds, disconnecting devices and other safety devices and their location are the responsibility of the user and are not provided by Hitachi Industrial Equipment Systems Co., Ltd.



CAUTION: Be sure to connect a motor thermal disconnect switch or overload device to the SJ100 series controller to assure that the inverter will shut down in the event of an overload or an overheated motor.



HIGH VOLTAGE: Dangerous voltage exists until power light is OFF. Wait at least five (5) minutes after input power is disconnected before performing maintenance.



WARNING: This equipment has high leakage current and must be permanently (fixed) hard-wired to earth ground via two independent cables.



WARNING: Rotating shafts and above-ground electrical potentials can be hazardous. Therefore, it is strongly recommended that all electrical work conform to the National Electrical Codes and local regulations. Installation, alignment and maintenance should be performed only by qualified personnel. Factory-recommended test procedures included in the instruction manual should be followed. Always disconnect electrical power before working on the unit.



CAUTION:

- a) Class I motor must be connected to earth ground via low resistive path ($< 0.1\Omega$)
- b) Any motor used must be of a suitable rating.
- c) Motors may have hazardous moving parts. In this event suitable protection must be provided.



CAUTION: Alarm connection may contain hazardous live voltage even when inverter is disconnected. When removing the front cover for maintenance or inspection, confirm that incoming power for alarm connection is completely disconnected.



CAUTION: Hazardous (main) terminals for any interconnection (motor, contact breaker, filter, etc.) must be inaccessible in the final installation.



CAUTION: This equipment should be installed in IP54 or equivalent (see EN60529) enclosure. The end application must be in accordance with BS EN60204-1. Refer to the section “Choosing a Mounting Location” on page 2–7. The diagram dimensions are to be suitably amended for your application.



CAUTION: Connection to field wiring terminals must be reliably fixed having two independent means of mechanical support. Use a termination with cable support (figure below), or strain relief, cable clamp, etc.

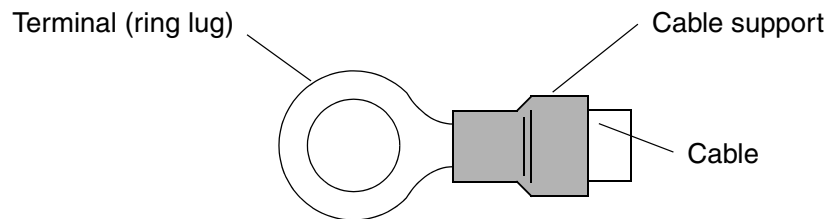









CAUTION: A double-pole disconnection device must be fitted to the incoming main power supply close to the inverter. Additionally, a protection device meeting IEC947-1/IEC947-3 must be fitted at this point (protection device data shown in “Determining Wire and Fuse Sizes” on page 2–14).





NOTE: The above instructions, together with any other requirements highlighted in this manual, must be followed for continued LVD (European Low Voltage Directive) compliance.

Index to Warnings and Cautions in This Manual

Installation - Cautions for Mounting Procedures

-  CAUTION: The inverter is shipped with a plastic cover over the top vent grill. REMOVE this cover after the installation is complete. Operation with this cover in place will not allow proper cooling, and damage to the inverter may result. 2-6
-  CAUTION: Be sure to install the unit on flame-resistant material such as a steel plate. Otherwise, there is the danger of fire. 2-7
-  CAUTION: Be sure not to place any flammable materials near the inverter. Otherwise, there is the danger of fire. 2-7
-  CAUTION: Be sure not to let the foreign matter enter vent openings in the inverter housing, such as wire clippings, spatter from welding, metal shavings, dust, etc. Otherwise, there is the danger of fire. 2-7
-  CAUTION: Be sure to install the inverter in a place that can bear the weight according to the specifications in the text (Chapter 1, Specifications Tables). Otherwise, it may fall and cause injury to personnel. 2-7
-  CAUTION: Be sure to install the unit on a perpendicular wall that is not subject to vibration. Otherwise, it may fall and cause injury to personnel. 2-7
-  CAUTION: Be sure not to install or operate an inverter that is damaged or has missing parts. Otherwise, it may cause injury to personnel. 2-7
-  CAUTION: Be sure to install the inverter in a well-ventilated room that does not have direct exposure to sunlight, a tendency for high temperature, high humidity or dew condensation, high levels of dust, corrosive gas, explosive gas, inflammable gas, grinding-fluid mist, salt damage, etc. Otherwise, there is the danger of fire. 2-7
-  CAUTION: Be sure to maintain the specified clearance area around the inverter and to provide adequate ventilation. Otherwise, the inverter may overheat and cause equipment damage or fire. 2-8

Wiring - Warnings for Electrical Practices and Wire Specifications

-  WARNING: "Use 60/75°C Cu wire only" or equivalent. 2-13
-  WARNING: "Open Type Equipment." 2-13
-  WARNING: "Suitable for use on a circuit capable of delivering not more than 5,000 rms symmetrical amperes, 240 V maximum." For models with suffix N or L. 2-13

- 

WARNING: “Suitable for use on a circuit capable of delivering not more than 5,000 rms symmetrical amperes, 480 V maximum.” For models with suffix H. 2-13
- 

HIGH VOLTAGE: Be sure to ground the unit. Otherwise, there is a danger of electric shock and/or fire. 2-13
- 

HIGH VOLTAGE: Wiring work shall be carried out only by qualified personnel. Otherwise, there is a danger of electric shock and/or fire. 2-13
- 

HIGH VOLTAGE: Implement wiring after checking that the power supply is OFF. Otherwise, you may incur electric shock and/or fire. 2-13
- 

HIGH VOLTAGE: Do not connect wiring to an inverter or operate an inverter that is not mounted according the instructions given in this manual. Otherwise, there is a danger of electric shock and/or injury to personnel. 2-13
- 

WARNING: Make sure the input power to the inverter is OFF. If the drive has been powered, leave it OFF for five minutes before continuing. 2-19

Wiring - Cautions for Electrical Practices

- 

CAUTION: Fasten the screws with the specified fastening torque in the table below. Check for any loosening of screws. Otherwise, there is the danger of fire. 2-15
- 

CAUTION: Be sure that the input voltage matches the inverter specifications: • Single/Three phase 200 to 240 V 50/60 Hz (up to 2.2kW) • Three phase 200 to 230V 50/60Hz (above 2.2kW) • Three phase 380 to 460 V 50/60Hz 2-16
- 

CAUTION: Be sure not to power a three-phase-only inverter with single phase power. Otherwise, there is the possibility of damage to the inverter and the danger of fire. 2-16
- 

CAUTION: Be sure not to connect an AC power supply to the output terminals. Otherwise, there is the possibility of damage to the inverter and the danger of injury and/or fire. 2-17

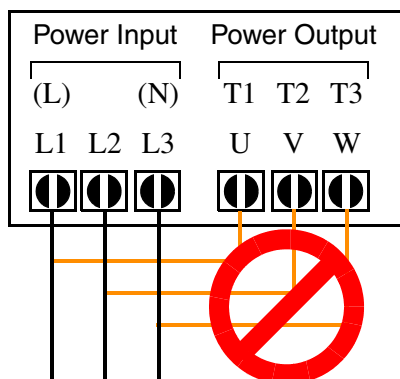

NOTE:

- L, N: Single-phase 200 to 240V 50/60 Hz
- L1, L2, L3: Three-phase 200 to 240V 50/60 Hz
- Three-phase 380 to 460V 50/60 Hz



CAUTION: Remarks for using ground fault interrupter breakers in the main power supply: Adjustable frequency inverters with CE-filters (RFI-filter) and shielded (screened) motor cables have a higher leakage current toward Earth GND. Especially at the moment of switching ON this can cause an inadvertent trip of ground fault interrupters. Because of the rectifier on the input side of the inverter there is the possibility to stall the switch-off function through small amounts of DC current. Please observe the following: • Use only short time-invariant and pulse current-sensitive ground fault interrupters with higher trigger current. • Other components should be secured with separate ground fault interrupters. • Ground fault interrupters in the power input wiring of an inverter are not an absolute protection against electric shock. 2-17



CAUTION: Be sure to install a fuse in each phase of the main power supply to the inverter. Otherwise, there is the danger of fire. 2-17



CAUTION: For motor leads, ground fault interrupter breakers and electromagnetic contactors, be sure to size these components properly (each must have the capacity for rated current and voltage). Otherwise, there is the danger of fire. 2-17

Powerup Test Caution Messages



CAUTION: The heat sink fins will have a high temperature. Be careful not to touch them. Otherwise, there is the danger of getting burned. 2-20



CAUTION: The operation of the inverter can be easily changed from low speed to high speed. Be sure to check the capability and limitations of the motor and machine before operating the inverter. Otherwise, there is the danger of injury. 2-20



CAUTION: If you operate a motor at a frequency higher than the inverter standard default setting (50Hz/60Hz), be sure to check the motor and machine specifications with the respective manufacturer. Only operate the motor at elevated frequencies after getting their approval. Otherwise, there is the danger of equipment damage and/or injury. 2-20, 2-24



CAUTION: Check the following before and during the powerup test. Otherwise, there is the danger of equipment damage. • Is the shorting bar between the [+1] and [+] terminals installed? DO NOT power or operate the inverter if the jumper is removed. • Is the direction of the motor rotation correct? • Did the inverter trip during acceleration or deceleration? • Were the rpm and frequency meter readings as expected? • Were there any abnormal motor vibrations or noise? 2-20

Warnings for Configuring Drive Parameters



WARNING: When parameter B_12, level of electronic thermal setting, is set to device FLA rating (Full Load Ampere nameplate rating), the device provides solid state motor overload protection at 115% of device FLA or equivalent. Parameter B_12, level of electronic thermal setting, is a variable parameter. 3–26

Cautions for Configuring Drive Parameters



CAUTION: Be careful to avoid specifying a braking time that is long enough to cause motor overheating. If you use DC braking, we recommend using a motor with a built-in thermistor, and wiring it to the inverter's thermistor input (see "Thermistor Thermal Protection" on page 4–22). Also refer to the motor manufacturer's specifications for duty-cycle recommendations during DC braking. 3–16

Warnings for Operations and Monitoring



WARNING: Be sure to turn ON the input power supply only after closing the front case. While the inverter is energized, be sure not to open the front case. Otherwise, there is the danger of electric shock. 4–3



WARNING: Be sure not to operate electrical equipment with wet hands. Otherwise, there is the danger of electric shock. 4–3



WARNING: While the inverter is energized, be sure not to touch the inverter terminals even when the motor is stopped. Otherwise, there is the danger of electric shock. 4–3



WARNING: If the Retry Mode is selected, the motor may suddenly restart after a trip stop. Be sure to stop the inverter before approaching the machine (be sure to design the machine so that safety for personnel is secure even if it restarts.) Otherwise, it may cause injury to personnel. 4–3









WARNING: If the power supply is cut OFF for a short period of time, the inverter may restart operation after the power supply recovers if the Run command is active. If a restart may pose danger to personnel, so be sure to use a lock-out circuit so that it will not restart after power recovery. Otherwise, it may cause injury to personnel. 4–3







WARNING: The Stop Key is effective only when the Stop function is enabled. Be sure to enable the Stop Key separately from the emergency stop. Otherwise, it may cause injury to personnel. 4–3









WARNING: During a trip event, if the alarm reset is applied and the Run command is present, the inverter will automatically restart. Be sure to apply the alarm reset only after verifying the Run command is OFF. Otherwise, it may cause injury to personnel. 4–3

-  **WARNING:** Be sure not to touch the inside of the energized inverter or to put any conductive object into it. Otherwise, there is a danger of electric shock and/or fire. 4-3
-  **WARNING:** If power is turned ON when the Run command is already active, the motor will automatically start and injury may result. Before turning ON the power, confirm that the RUN command is not present. 4-3
-  **WARNING:** When the Stop key function is disabled, pressing the Stop key does not stop the inverter, nor will it reset a trip alarm. 4-3
-  **WARNING:** Be sure to provide a separate, hard-wired emergency stop switch when the application warrants it. 4-3
-  **WARNING:** If the power is turned ON and the Run command is already active, the motor starts rotation and is dangerous! Before turning power ON, confirm that the Run command is not active. 4-9
-  **WARNING:** After the Reset command is given and the alarm reset occurs, the motor will restart suddenly if the Run command is already active. Be sure to set the alarm reset after verifying that the Run command is OFF to prevent injury to personnel. 4-21
-  **WARNING:** You may need to disconnect the load from the motor before performing auto-tuning. The inverter runs the motor forward and backward for several seconds without regard to load movement limits. 4-35





Cautions for Operations and Monitoring

-  **CAUTION:** The heat sink fins will have a high temperature. Be careful not to touch them. Otherwise, there is the danger of getting burned. 4-2
-  **CAUTION:** The operation of the inverter can be easily changed from low speed to high speed. Be sure check the capability and limitations of the motor and machine before operating the inverter. Otherwise, it may cause injury to personnel. 4-2
-  **CAUTION:** If you operate a motor at a frequency higher than the inverter standard default setting (50Hz/60Hz), be sure to check the motor and machine specifications with the respective manufacturer. Only operate the motor at elevated frequencies after getting their approval. Otherwise, there is the danger of equipment damage. 4-2
-  **CAUTION:** It is possible to damage the inverter or other devices if your application exceeds the maximum current or voltage characteristics of a connection point. 4-4

Warnings and Cautions for Troubleshooting and Maintenance

- | | | |
|-----------------------------------------------------------------------------------|-------------------------------------------------------------------------------------------------------------------------------------------------------------------------------------------------------------------------------------------------------------------------------------------------------------------------------------------------|-----------|
|  | WARNING: Wait at least five (5) minutes after turning OFF the input power supply before performing maintenance or an inspection. Otherwise, there is the danger of electric shock. | 6-2 |
|  | WARNING: Make sure that only qualified personnel will perform maintenance, inspection, and part replacement. Before starting to work, remove any metallic objects from your person (wristwatch, bracelet, etc.). Be sure to use tools with insulated handles. Otherwise, there is a danger of electric shock and/or injury to personnel. | 6-2 |
|  | WARNING: Never remove connectors by pulling on its wire leads (wires for cooling fan and logic P.C.board). Otherwise, there is a danger of fire due to wire breakage and/or injury to personnel. | 6-2 |
|  | CAUTION: Do not connect the megger to any control circuit terminals such as intelligent I/O, analog terminals, etc. Doing so could cause damage to the inverter. | 6-10 |
|  | CAUTION: Never test the withstand voltage (HIPOT) on the inverter. The inverter has a surge protector between the main circuit terminals above and the chassis ground. | 6-10 |
|  | HIGH VOLTAGE: Be careful not to touch wiring or connector terminals when working with the inverters and taking measurements. Be sure to place the measurement circuitry components above in an insulated housing before using them. | 6-14 |

General Warnings and Cautions

- | | |
|-------------------------------------------------------------------------------------|-----------------------------------------------------------------------------------------------------------------------------------------------------------------------------------------|
|  | WARNING: Never modify the unit. Otherwise, there is a danger of electric shock and/or injury. |
|  | CAUTION: Withstand voltage tests and insulation resistance tests (HIPOT) are executed before the units are shipped, so there is no need to conduct these tests before operation. |
|  | CAUTION: Do not attach or remove wiring or connectors when power is applied. Also, do not check signals during operation. |
|  | CAUTION: Be sure to connect the grounding terminal to earth ground. |
|  | CAUTION: When inspecting the unit, be sure to wait five minutes after tuning OFF the power supply before opening the cover. |



CAUTION: Do not stop operation by switching OFF electromagnetic contactors on the primary or secondary sides of the inverter.

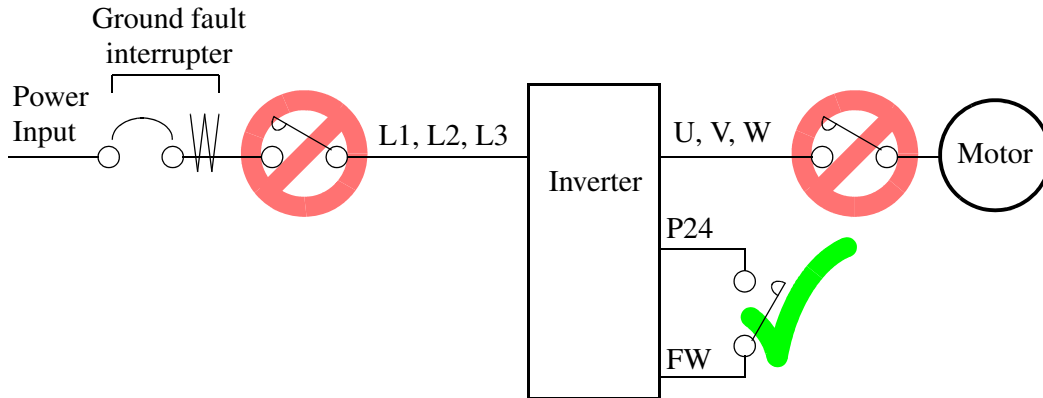

When there has been a sudden power failure while an operation instruction is active, then the unit may restart operation automatically after the power failure has ended. If there is a possibility that such an occurrence may harm humans, then install an electromagnetic contactor (Mgo) on the power supply side, so that the circuit does not allow automatic restarting after the power supply recovers. If the optional remote operator is used and the retry function has been selected, this will also cause automatic restarting when a Run command is active. So, please be careful.



CAUTION: Do not insert leading power factor capacitors or surge absorbers between the output terminals of the inverter and motor.

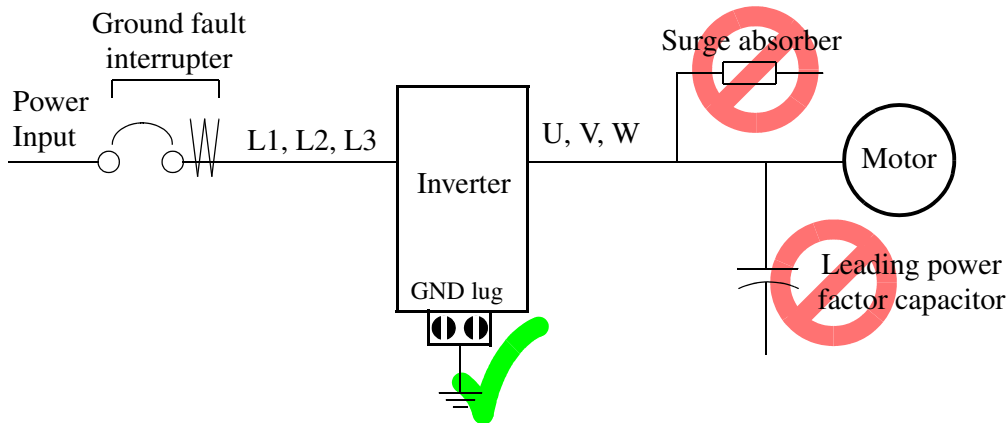

CAUTION: MOTOR TERMINAL SURGE VOLTAGE SUPPRESSION FILTER (For the 400 V CLASS)

In a system using an inverter with the voltage control PWM system, a voltage surge caused by the cable constants such as the cable length (especially when the distance between the motor and inverter is 10 m or more) and cabling method may occur at the motor terminals. A dedicated filter of the 400 V class for suppressing this voltage surge is available. Be sure to install a filter in this situation.



CAUTION: SUPPRESSION FOR NOISE INTERFERENCE FROM INVERTER

The inverter uses many semiconductor switching elements such as transistors and IGBTs. Thus, a radio receiver or measuring instrument located near the inverter is susceptible to noise interference.

To protect the instruments from erroneous operation due to noise interference, they should be used well away from the inverter. It is also effective to shield the whole inverter structure.

The addition of an EMI filter on the input side of the inverter also reduces the effect of noise from the commercial power line on external devices.

Note that the external dispersion of noise from the power line can be minimized by connecting an EMI filter on the primary side of inverter.

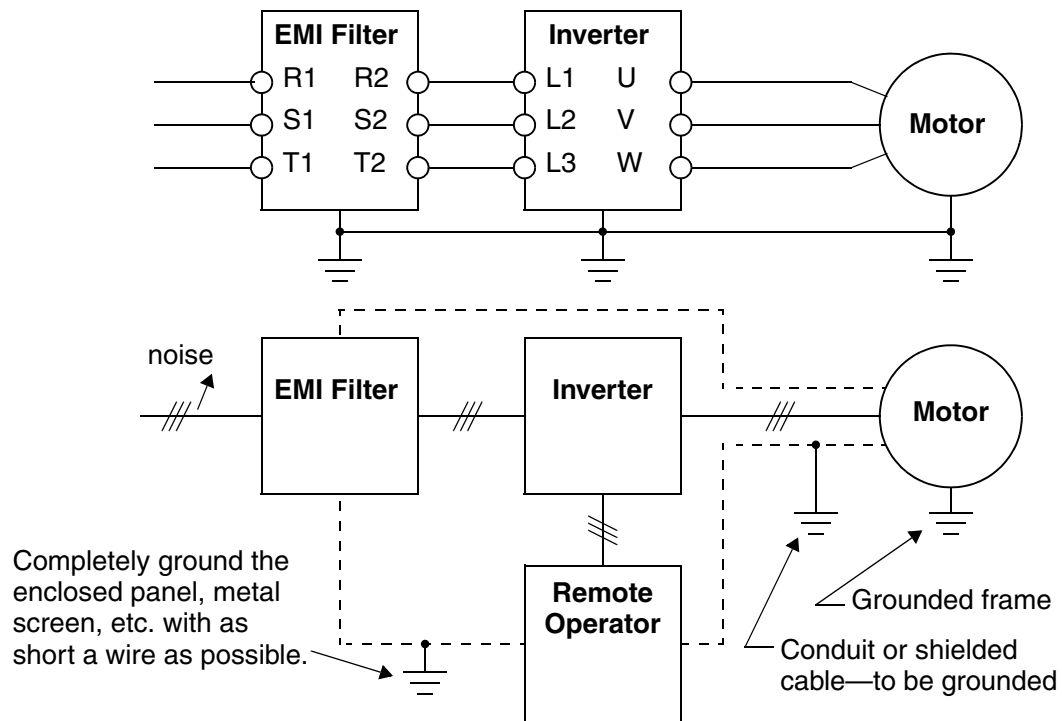

CAUTION: EFFECTS OF POWER DISTRIBUTION SYSTEM ON INVERTER

In the cases below involving a general-purpose inverter, a large peak current can flow on the power supply side, sometimes destroying the converter module:

1. The unbalance factor of the power supply is 3% or higher.
2. The power supply capacity is at least 10 times greater than the inverter capacity (or the power supply capacity is 500 kVA or more).
3. Abrupt power supply changes are expected, due to conditions such as:
 - a. Several inverters are interconnected with a short bus.
 - b. A thyristor converter and an inverter are interconnected with a short bus.
 - c. An installed phase advance capacitor opens and closes.

Where these conditions exist or when the connected equipment must be highly reliable, you **MUST** install an input-side AC reactor of 3% (at a voltage drop at rated current) with respect to the supply voltage on the power supply side. Also, where the effects of an indirect lightning strike are possible, install a lightning conductor.



CAUTION: When the EEPROM error E08 occurs, be sure to confirm the setting values again.



CAUTION: When using *normally closed* active state settings (C_11 to C_16) for externally commanded Forward or Reverse terminals [FW] or [RV], the inverter may start automatically *when the external system is powered OFF or disconnected from the inverter!* So, do not use normally closed active state settings for Forward or Reverse terminals [FW] or [RV] unless your system design protects against unintended motor operation.



CAUTION: In all the illustrations in this manual, covers and safety devices are occasionally removed to describe the details. While operating the product, make sure that the covers and safety devices are placed as they were specified originally and operate it according to the instruction manual.

UL[®] Cautions, Warnings, and Instructions

Wiring Warnings for Electrical Practices and Wire Sizes

The Cautions, Warnings, and instructions in this section summarize the procedures necessary to ensure an inverter installation complies with Underwriters Laboratories[®] guidelines.



WARNING: “Use 60/75°C Cu wire only” or equivalent.



WARNING: “Open Type Equipment.”



WARNING: “Suitable for use on a circuit capable of delivering not more than 5,000 rms symmetrical amperes, 240 V maximum.” For models with suffix N or L.



WARNING: “Suitable for use on a circuit capable of delivering not more than 5,000 rms symmetrical amperes, 480 V maximum.” For models with suffix H.

Terminal Tightening Torque and Wire Size

The wire size range and tightening torque for field wiring terminals are presented in the table below.

Input Voltage	Motor Output		Inverter Model	Wiring Size Range (AWG)	Torque	
	kW	HP			ft-lbs	(N-m)
200V	0.2	1/4	SJ100-002NFE/NFU	16	0.6	0.8
	0.4	1/2	SJ100-004NFE/NFU			
	0.55	3/4	SJ100-005NFE			
	0.75	1	SJ100-007NFE/NFU	14	0.9	1.2
	1.1	1 1/2	SJ100-011NFE			
	1.5	2	SJ100-015NFE/NFU			
	2.2	3	SJ100-022NFE/NFU			
	3.7	5	SJ100-037LFU			
	5.5	7 1/2	SJ100-055LFU	10	1.5	2.0
	7.5	10	SJ100-075LFU	8		
400V	0.4	1/2	SJ100-004HFE/HFU	16	0.9	1.2
	0.75	1	SJ100-007HFE/HFU			
	1.5	2	SJ100-015HFE/HFU			
	2.2	3	SJ100-022HFE/HFU			
	3.0	4	SJ100-030HFE	14	1.5	2.0
	4.0	5	SJ100-040HFE/HFU			
	5.5	7 1/2	SJ100-055HFE/HFU	12		
	7.5	10	SJ100-075HFE/HFU			

Wire Connectors



WARNING: Field wiring connections must be made by a UL Listed and CSA Certified ring lug terminal connector sized for the wire gauge being used. The connector must be fixed using the crimping tool specified by the connector manufacturer.

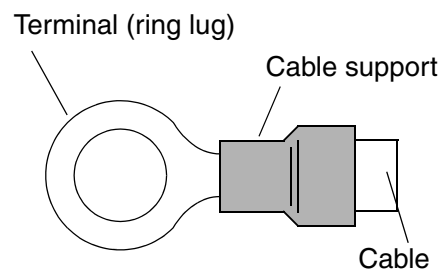

Circuit Breaker and Fuse Sizes

The inverter's connections to input power must include UL Listed inverse time circuit breakers with 600V rating, or UL Listed fuses as shown in the table below.

Input Voltage	Motor Output		Inverter Model	Fuse (A) (UL-rated, class J, 600V)
	kW	HP		
200V	0.2	1/4	SJ100-002NFE/NFU	10
	0.4	1/2	SJ100-004NFE/NFU	10
	0.55	3/4	SJ100-005NFE	10
	0.75	1	SJ100-007NFE/NFU	15
	1.1	1 1/2	SJ100-011NFE	15
	1.5	2	SJ100-015NFE/NFU	20 (single ph.) 15 (three ph.)
	2.2	3	SJ100-022NFE/NFU	30 (single ph.) 20 (three ph.)
	3.7	5	SJ100-037LFU	30
	5.5	7 1/2	SJ100-055LFU	40
	7.5	10	SJ100-075LFU	50
400V	0.4	1/2	SJ100-004HFE/HFU	3
	0.75	1	SJ100-007HFE/HFU	6
	1.5	2	SJ100-015HFE/HFU	10
	2.2	3	SJ100-022HFE/HFU	10
	3.0	4	SJ100-030HFE	15
	4.0	5	SJ100-040HFE/HFU	15
	5.5	7 1/2	SJ100-055HFE/HFU	20
	7.5	10	SJ100-075HFE/HFU	25

Motor Overload Protection

Hitachi SJ100 inverters provide solid state motor overload protection, which depends on the proper setting of the following parameters:

- B_12 “electronic overload protection”
- B212 “electronic overload protection, 2nd motor”

Set the rated current [Amperes] of the motor(s) with the above parameters. The setting range is 0.5 * rated current to 1.2 * rated current.



WARNING: When two or more motors are connected to the inverter, they cannot be protected by the electronic overload protection. Install an external thermal relay on each motor.